

# Habitat Natural

## índice geral



53



105

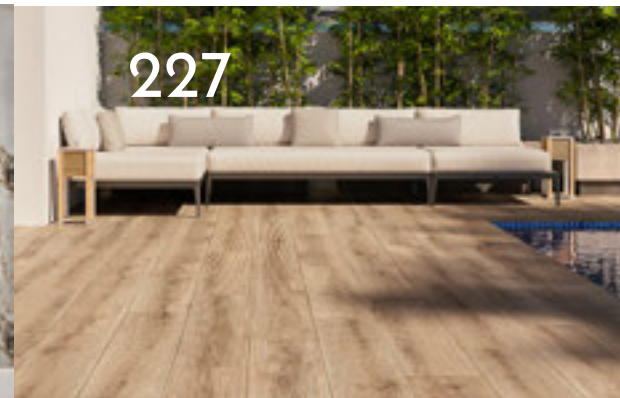

227



349

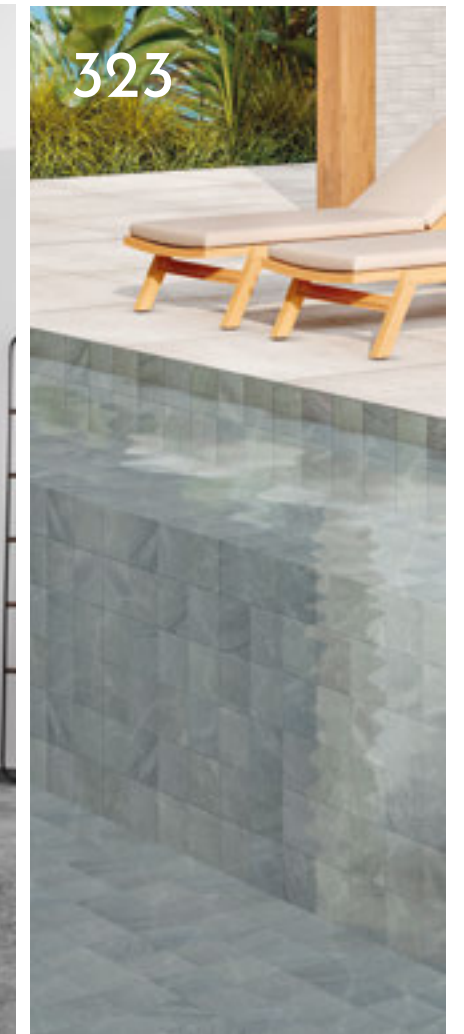

323



99

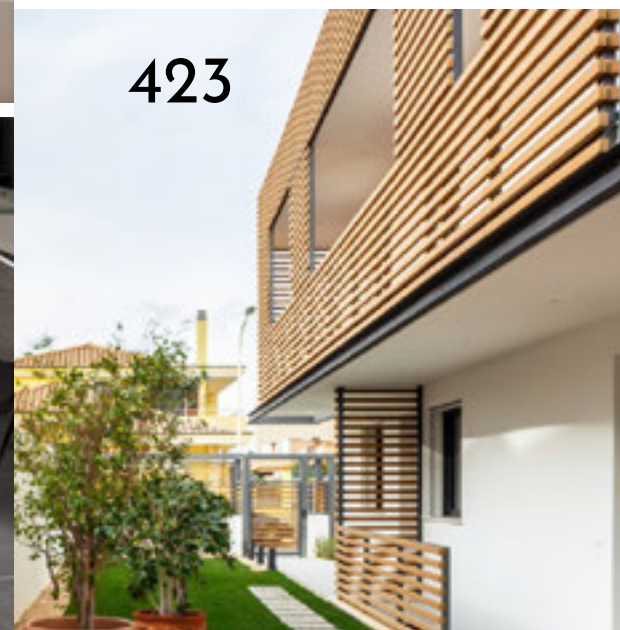

423

### 09. LÂMINA 260x120

Porcelain Slab 260x120  
Dalle 260x120  
Großformatige Fliesen 260x120  
Láminas porcelánicas 260x120 Pulido

### 86. PORCELÂNICOS POLIDOS E MATES

Porcelain tiles polish and matt / Gres cérame émaillé poli et mate  
Feinsteinzeug poliert und matt / Porcelánico pulido y mate

### 223. MADEIRAS PORCELÂNICAS

Porcelain tiles wood effect / Carrelages effet bois  
Feinsteinzeugfliesen mit Holzeffekt / Porcelánicos imitación madera

### 237. REVESTIMENTO PAREDES

Wall tiles / Revêtement mural / Revestimiento de pared / Wandfliesen

### 259. ESPESSURADOS

high thickness tiles / carrelage de forte épaisseur  
baldosas de gran espesor / Fliesen mit hoher Dicke

### 266. PEÇAS ESPECIAIS - RODAPÉS, DEGRAUS E GRELHAS

Special items - skirtings, steps and grids / Pièces spéciales - plinthes, marches et grilles  
Spezialteile - rücke, stufen und grills / Piezas especiales - rodapiés, peldaños y rejillas

### 270. PERFIS

Profils / Profiles / Profilo / Perfiles

### 273. NIVELADORES

Tile Spacers / Croisillons / Fliesenabstandhalter / Niveladores

### 274. PEDESTAIS PARA PISO ELEVADO

adjustable supports for exterior elevated floors / plots réglables pour planchers surélevés extérieurs  
soportes ajustables para pisos exteriores elevados / verstellbare Sockelstützen für Doppelböden im Außenbereich

### 276. PEDRAS NATURAIS

Natural Stone / Pierres Naturelles / Naturstein / Piedras Naturales

### 308. FINASTONE

Flexible natural stone / Pierre naturelle flexible  
Flexibler naturstein / Piedra natural fleplotxible

### 320. PASTILHAS DE PISCINA

Pool mosaics / Mosaïques de piscine  
Pool-Mosaiken / Mosaicos para piscina

### 338. PASTILHAS DECORATIVAS

Decor mosaics / Mosaïques decoratives  
Dekor Mosaïke / Mosaicos decorativos

### 410. REV. FACHADA RIPADO

Co-Extrusion Cladding / Bardage composite coextrudée  
Co-Extrusionsverkleidung Cla / Revestimiento de coextrusión

### 428. PARÂMETROS TÉCNICOS

Technical specifications / Paramètres techniques  
Technische Spezifikationen / Parâmetros técnicos

### 438 EXPOSIÇÃO

Displays for tiles / Présentoirs pour carrelage  
Keramischen Ausstellungssystemetändern / Expositores para cerámica









**LÁMINAS**  
Extra Large Slabs / Dalle grand format  
Großformatige Fliesen / Láminas porcelánicas





Porcelânico Esmaltado  
Glazed tiles, Grès cérame émaille,  
Feinsteinzeug Glasiert, Porcelánico esmaltado



Retificado  
Rectified / Rectifié / Verarbeitet / Rectificado



Pisos e Paredes  
Floor and Walls / Sol et Mur  
Wandfliesen und Bodenfliesen / Pisos y Paredes



Varição Média V2  
Average tone variation / Variation moyenne  
Durchschnittliche Tonhöhenchwankung  
Variación media de tono



Resistente ao gelo  
Frost resistant / Résistant au gel  
Frostbeständig / Resistente al hielo



Espessura  
Thickness / Épaisseur / Dicke / Grosor



Recomendamos o uso de niveladores  
Recommended levelers / croisillons auto-nivellants conseillé  
Empfohlene Richtmaschinen / Niveladores recomendados



PCS  
1 Pcs  
3,12 m<sup>2</sup>  
45,50 Kg



PAL  
21 Pcs  
65,52 m<sup>2</sup>  
956 Kg

Caixa de embalagem de Lâminas  
até 21pcs/cx - C200/280, ref.: CKLAM.

## Apollo White Bookmatch

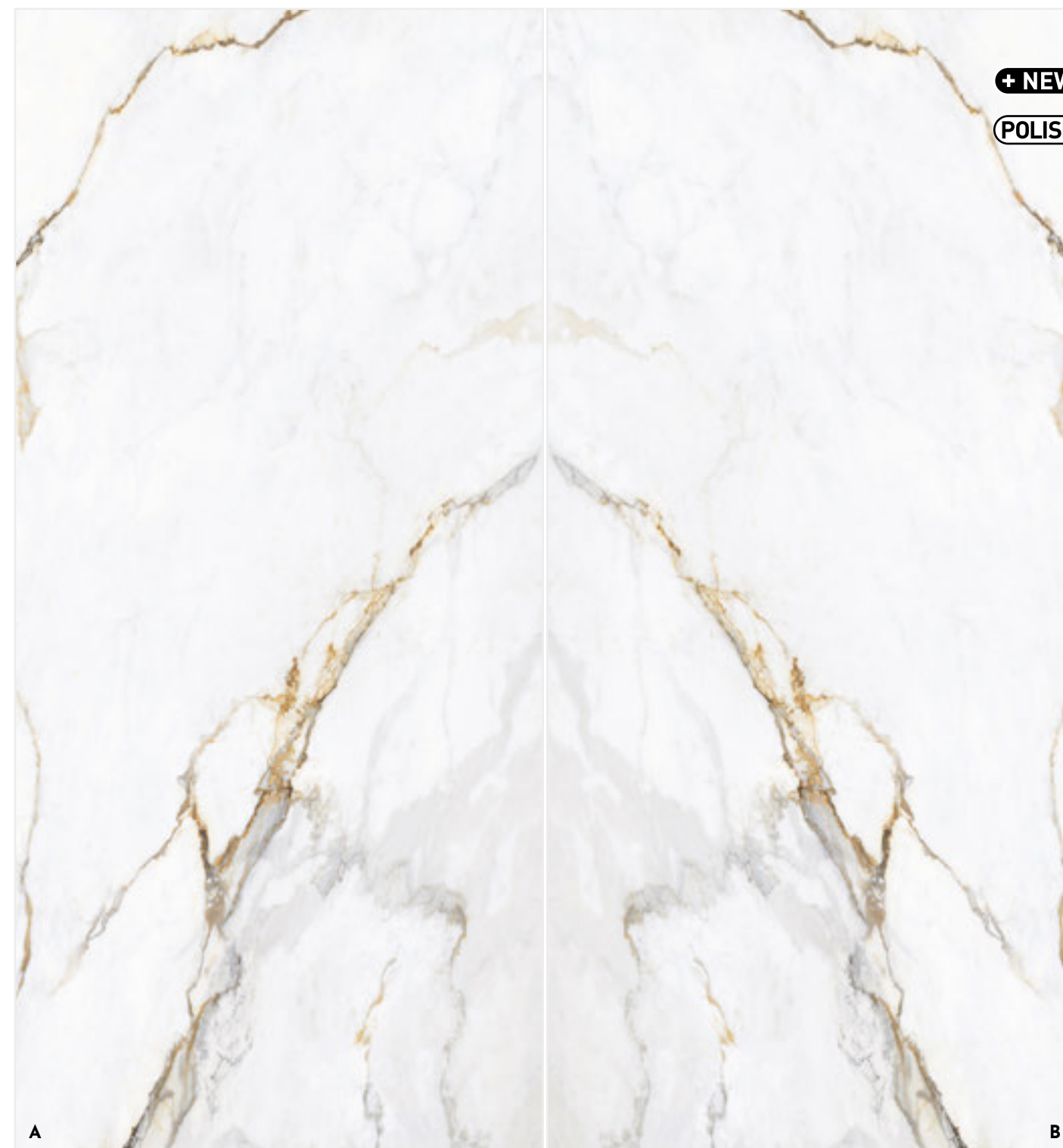

+ NEW

POLISH

260x120 Porcelânico

L80/120

Série: Apollo White - Polido

Ref.: RLM260120APWP



5 606779 251855



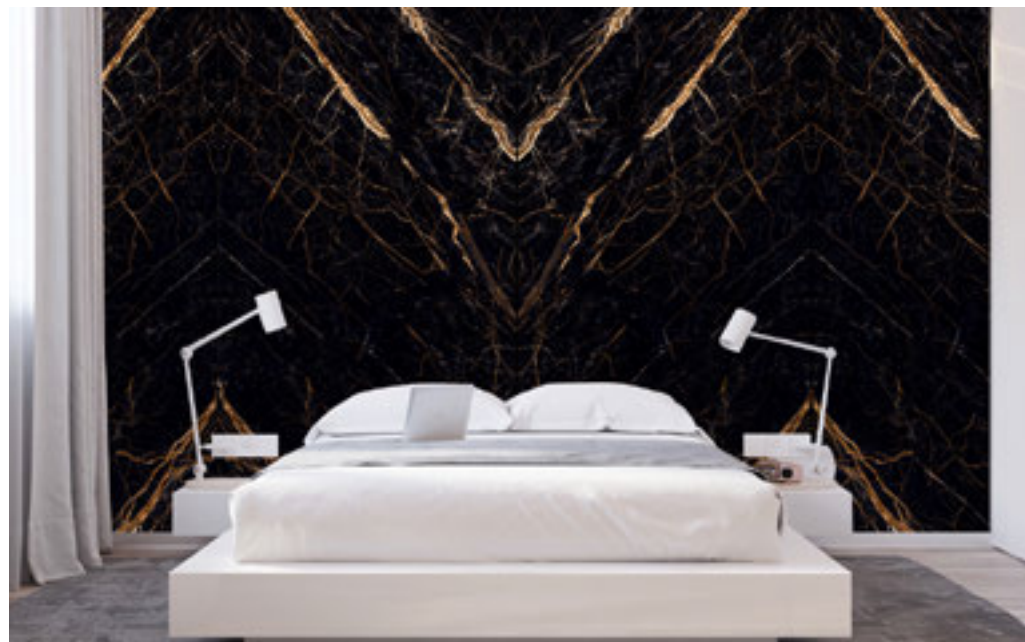

Porcelânico Esmaltado  
Glazed tiles, Grès cérame émaillé,  
Feinsteinzeug Glasiert, Porcelánico esmaltado



Retificado  
Rectified / Rectifié / Verarbeitet / Rectificado



Pisos e Paredes  
Floor and Walls / Sol et Mur  
Wandfliesen und Bodenfliesen / Pisos y Paredes



Varição Média V2  
Average tone variation / Variation moyenne  
Durchschnittliche Tonhöenschwankung  
Variación media de tono



Resistente ao gelo  
Frost resistant / Résistant au gel  
Frostbeständig / Resistente al hielo



Espessura  
Thickness / Épaisseur / Dicke / Grosor



Recomendamos o uso de niveladores  
Recommended levelers / croisillons auto-nivellants conseillé  
Empfohlene Richtmaschinen / Niveladores recomendados



**PCS**  
1 Pcs  
3,12 m<sup>2</sup>  
45,50 Kg



**PAL**  
21 Pcs  
65,52 m<sup>2</sup>  
956 Kg

Caixa de embolamento de Lâminas  
até 21pcs/cx - C200/280, ref.: CXLAM.

# Magma Black

## Bookmatch

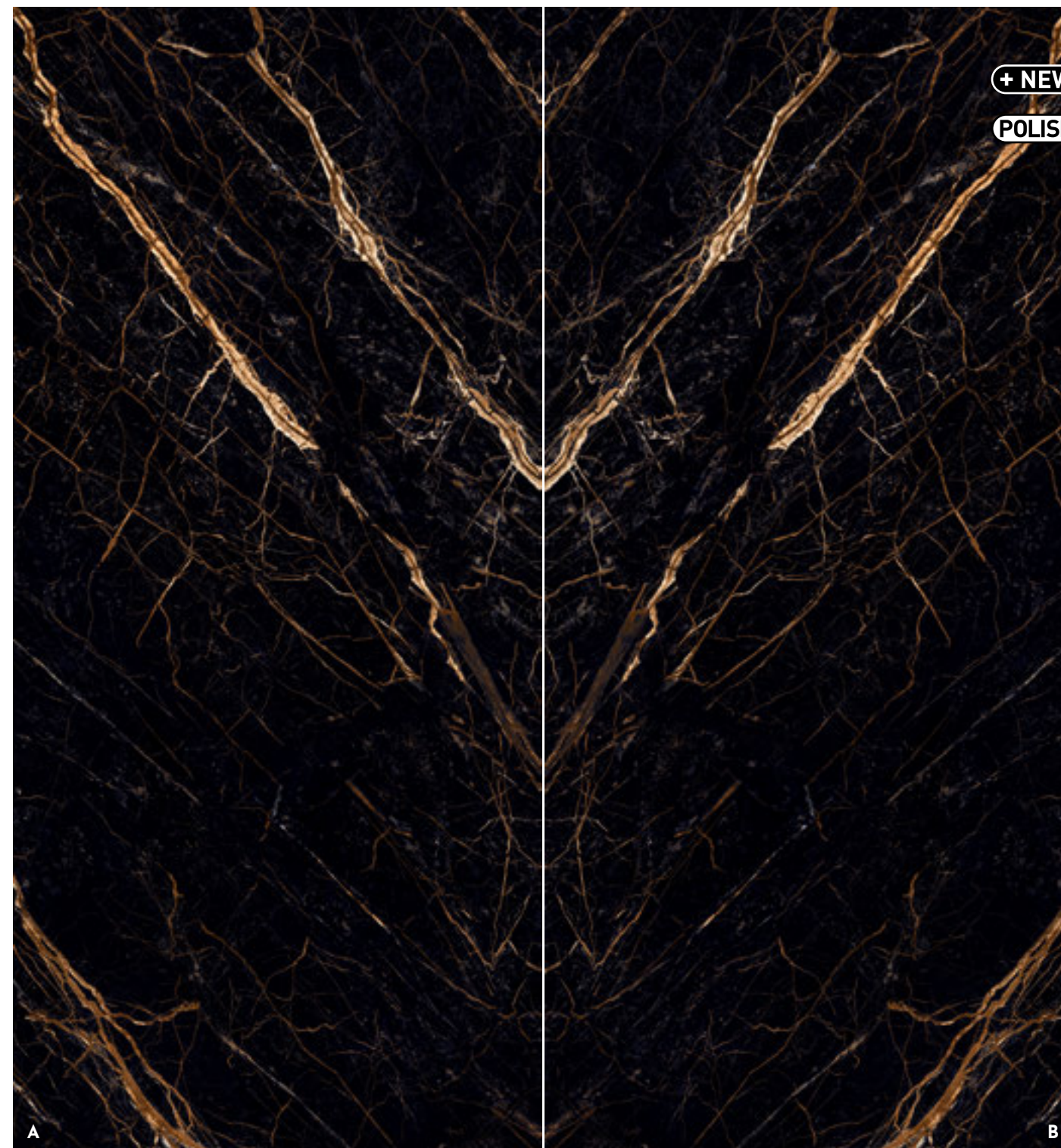

+ NEW

POLISH

260x120 Porcelânico

L80/120

Série: **Magma Black - Polido**

Ref.: RLM260120MGBLP



5 606779 251862





## Veios contínuos

Continuous veins / Veinage continu / kontinuierliches Arbeiten / superficies continuas

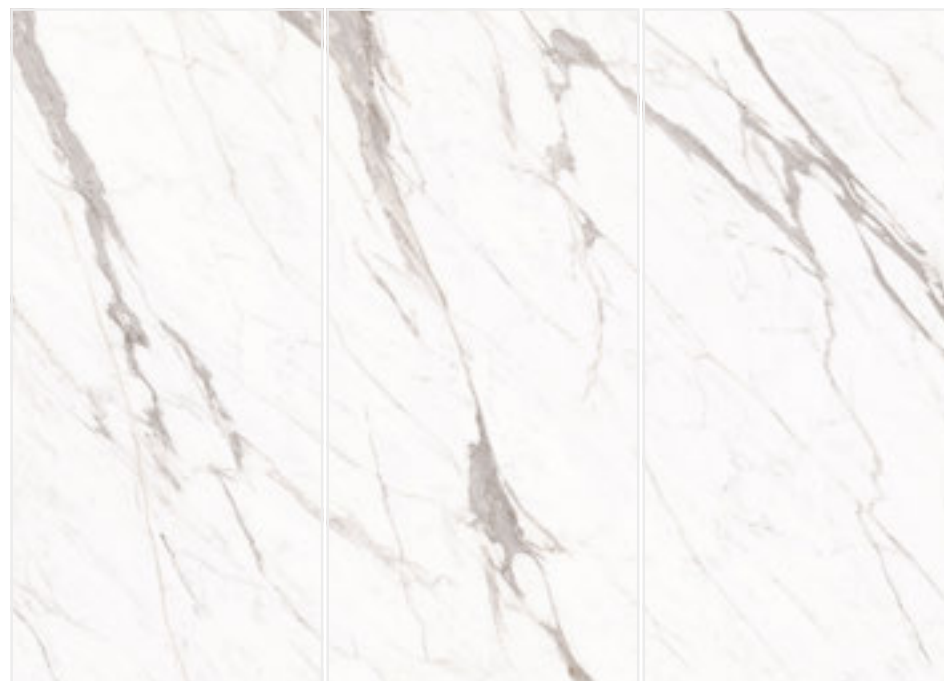

3A

3B

3C

PE

Porcelânico Esmaltado  
Glazed tiles / Grès cérame émaillé,  
Feinsteinzeug Glasier, Porcelánico esmaltado

RET

Retificado  
Rectified / Rectifié / Verarbeitet / Rectificado

Pisos e Paredes  
Floor and Walls / Sol et Mur  
Wandfliesen und Bodenfliesen / Pisos y Paredes

Varição Média V3  
Average tone variation / Variation moyenne  
Durchschnittliche Tonhöhenchwankung  
Variación media de tono

Resistente ao gelo  
Frost resistant / Résistant au gel  
Frostbeständig / Resistente al hielo

Espessura  
Thickness / Épaisseur / Dicke / Grosor

Recomendamos o uso de niveladores  
Recommended levelers / craisillons auto-nivellants conseillé  
Empfohlene Richtmaschinen / Niveladores recomendados

PCS

1 Pcs  
3,12 m<sup>2</sup>  
45,50 Kg

PAL

21 Pcs  
65,52 m<sup>2</sup>  
956 Kg

Caixa de embalagem de Láminas  
até 21pcs/cx - C200/280, ref.: CXLAM.

## Statuario Tan



2,60 m

260x120 Porcelânico

L80/120

Série: **Statuario Tan - Polido**

Ref.: RLM120260STATAN



5 606779 229762



## Veios contínuos

Continuous veins / Veinage continu / kontinuierliches Arbeiten / superficies continuas

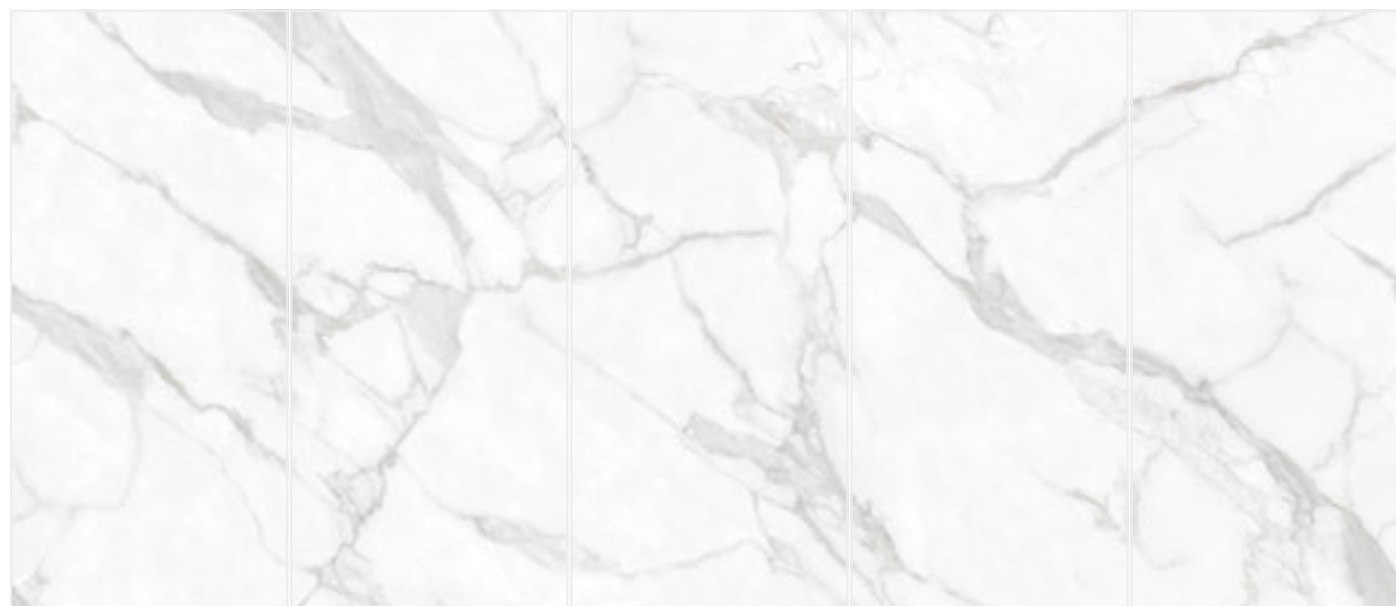

5A

5B

5C

5D

5E



Porcelânico Esmaltado  
Glazed tiles, Grès cérame émaillé,  
Feinsteinzeug Glasiert, Porcelánico esmaltado



Retificado  
Rectified / Rectifié / Verarbeitet / Rectificado



Pisos e Paredes  
Floor and Walls / Sol et Mur  
Wandfliesen und Bodenfliesen / Pisos y Paredes



Variação Média V3  
Average tone variation / Variation moyenne  
Durchschnittliche Tonhöhenchwankung  
Variación media de tono



Resistente ao gelo  
Frost resistant / Résistant au gel  
Frostbeständig / Resistente al hielo



Espessura  
Thickness / Épaisseur / Dicke / Grosor



Recomendamos o uso de niveladores  
Recommended levelers / craisillons auto-nivellants conseillé  
Empfohlene Richtmaschinen / Niveladores recomendados



PCS  
1 Pcs  
3,12 m<sup>2</sup>  
45,50 Kg



PAL  
21 Pcs  
65,52 m<sup>2</sup>  
956 Kg

Caixa de embalagem de Láminas  
até 21pcs/cx - C200/280, ref.: CXLAM.

## Statuario Venature

2,60 m



260x120 PORCELÂNICO

L80/120

Série: **Stat Venature - Polido**

Ref.: RLM120260STVENP



5 606779 219336





## Veios contínuos

Continuous veins / Veinage continu / kontinuierliches Arbeiten / superficies continuas

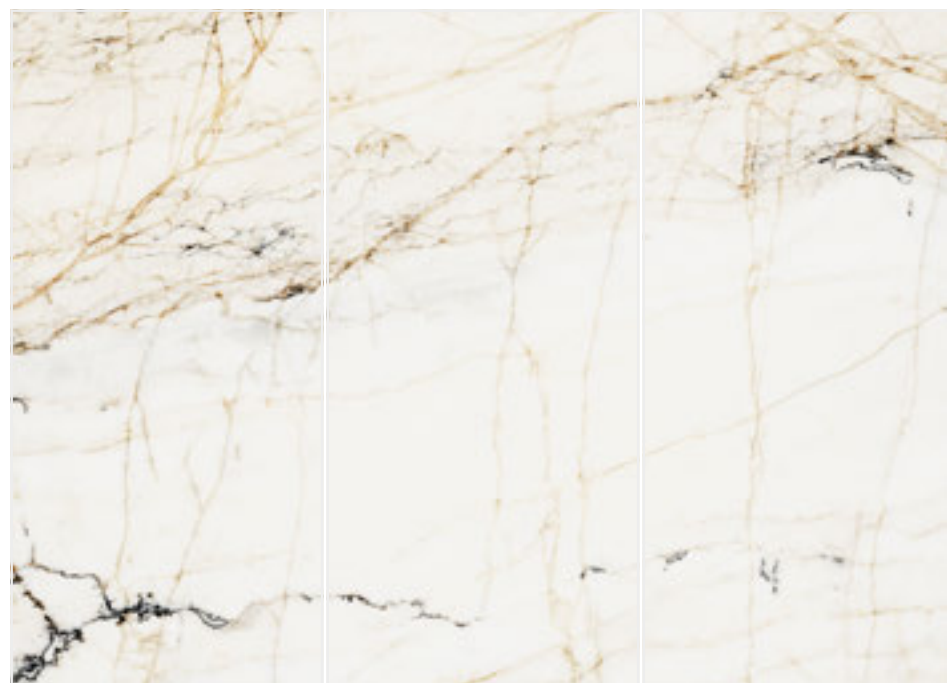

3A

3B

3C

# Afyon

2,60 m

PE

Porcelânico Esmaltado  
Glazed tiles, Grès cérame émaillé,  
Feinsteinzeug Glasiert, Porcelánico esmaltado

RET

Retificado  
Rectified / Rectifié / Verarbeitet / Rectificado

Pisos e Paredes  
Floor and Walls / Sol et Mur  
Wandfliesen und Bodenfliesen / Pisos y Paredes

Variação Média V3  
Average tone variation / Variation moyenne  
Durchschnittliche Tonhöhen schwankung  
Variación media de tono

Resistente ao gelo  
Frost resistant / Résistant au gel  
Frostbeständig / Resistente al hielo

Espessura  
Thickness / Épaisseur / Dicke / Grosor

Recomendamos o uso de niveladores  
Recommended levelers / craisillons auto-nivellants conseillé  
Empfohlene Richtmaschinen / Niveladores recomendados

PCS

1 Pcs  
3,12 m<sup>2</sup>  
45,50 Kg

PAL

21 Pcs  
65,52 m<sup>2</sup>  
956 Kg

Caixa de embalagem de Lâminas  
até 21pcs/cx - C200/280, ref.: CXLAM.

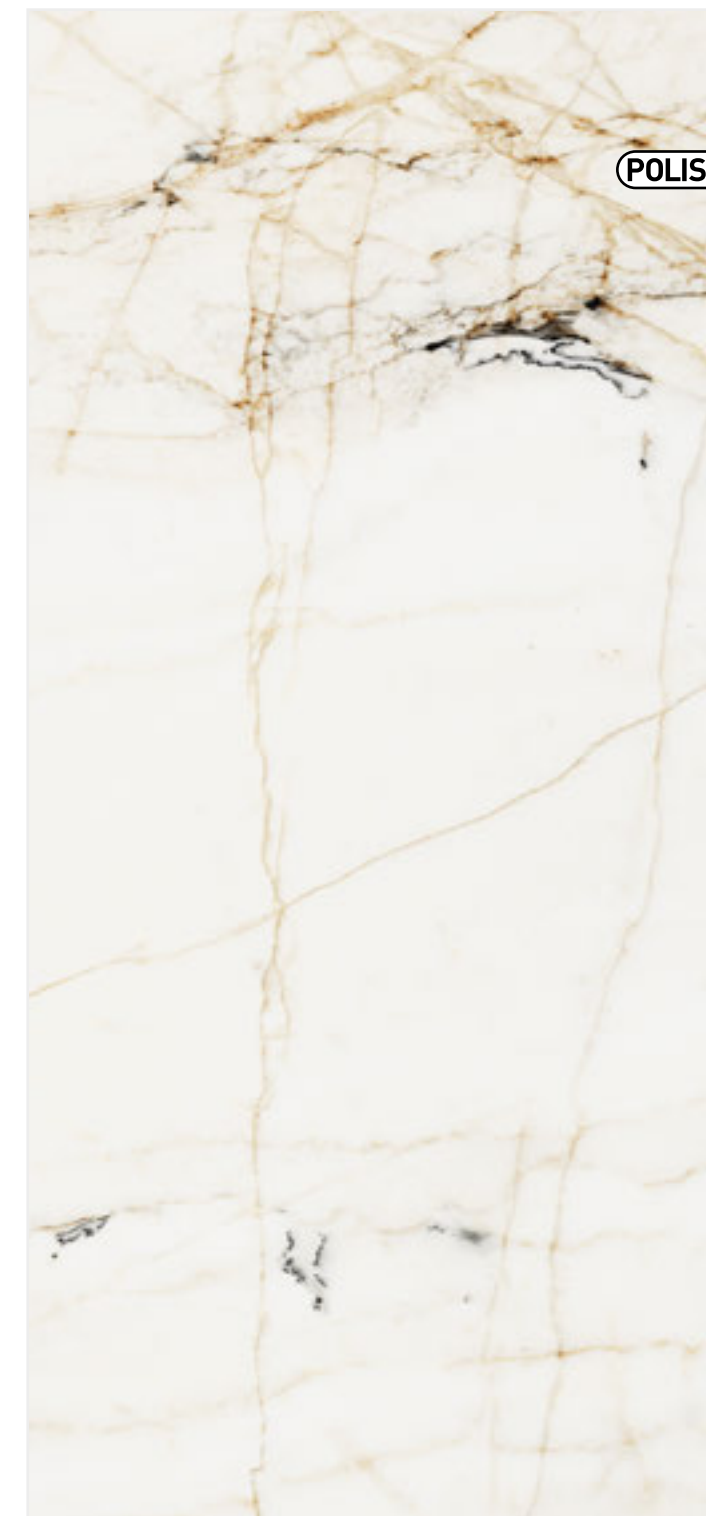

260x120 PORCELÂNICO

L80/120

Série: Afyon - Polido

Ref.: RLM120260AFYP



5 606779 219329



## Statuario Delicato

2,60 m



Porcelânico Esmaltado  
Glazed tiles, Grès cérame émaillé,  
Feinsteinzeug Glasier, Porcelánico esmaltado



Retificado  
Rectified / Rectifié / Verarbeitet / Rectificado



Pisos e Paredes  
Floor and Walls / Sol et Mur  
Wandfliesen und Bodenfliesen / Pisos y Paredes



Variação Média V3  
Average tone variation / Variation moyenne  
Durchschnittliche Tonhöhenchwankung  
Variación media de tono



Resistente ao gelo  
Frost resistant / Résistant au gel  
Frostbeständig / Resistente al hielo



Espessura  
Thickness / Épaisseur / Dicke / Grosor



Recomendamos o uso de niveladores  
Recommended levelers / craisillons auto-nivellants conseillé  
Empfohlene Richtmaschinen / Niveladores recomendados



PCS  
1 Pcs  
3,12 m<sup>2</sup>  
45,50 Kg



PAL  
21 Pcs  
65,52 m<sup>2</sup>  
956 Kg

Caixa de embalagem de Láminas  
até 21pcs/cx - C200/280, ref.: CXLAM.

+ NEW

POLISH

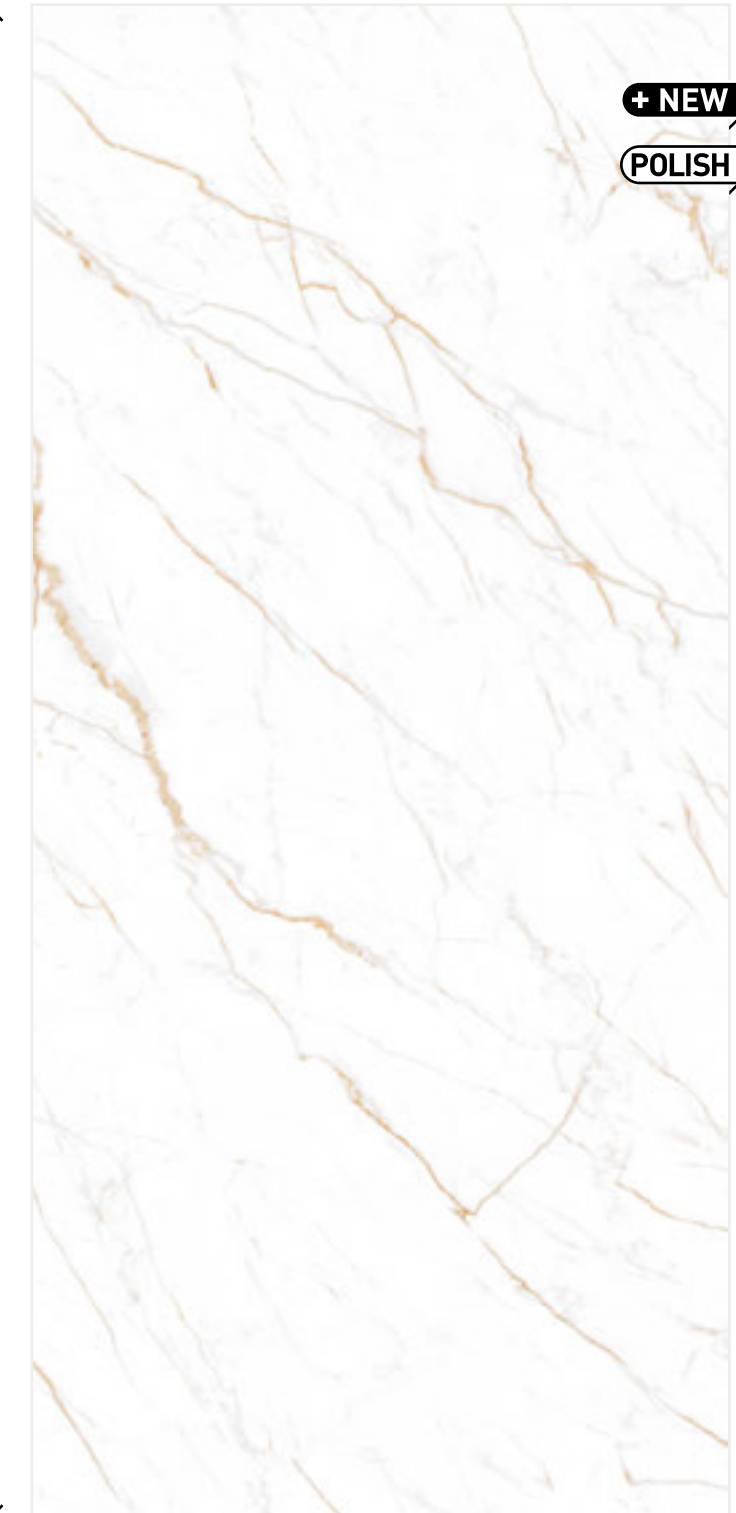

260x120 PORCELÂNICO

L80/120

Série: **Statuario Delicato - Polido**

Ref.: RLM120260STADEL



5 606779 229731





PE

Porcelânico Esmaltado  
Glazed tiles, Grès cérame émaillé,  
Feinsteinzeug Glasier, Porcelánico esmaltado

RET

Retificado  
Rectified / Rectifié / Verarbeitet / Rectificado



Pisos e Paredes  
Floor and Walls / Sol et Mur  
Wandfliesen und Bodenfliesen / Pisos y Paredes



Variação Média V3  
Average tone variation / Variation moyenne  
Durchschnittliche Tonhöhenchwankung  
Variación media de tono



Resistente ao gelo  
Frost resistant / Résistant au gel  
Frostbeständig / Resistente al hielo



Espessura  
Thickness / Épaisseur / Dicke / Grosor



Recomendamos o uso de niveladores  
Recommended levelers / craisillons auto-nivellants conseillé  
Empfohlene Richtmaschinen / Niveladores recomendados

PCS

1 Pcs  
3,12 m<sup>2</sup>  
45,50 Kg

PAL

21 Pcs  
65,52 m<sup>2</sup>  
956 Kg

Caixa de embalagem de Láminas  
até 21pcs/cx - C200/280, ref.: CXLAM.

## Arabesko Silver

2,60 m

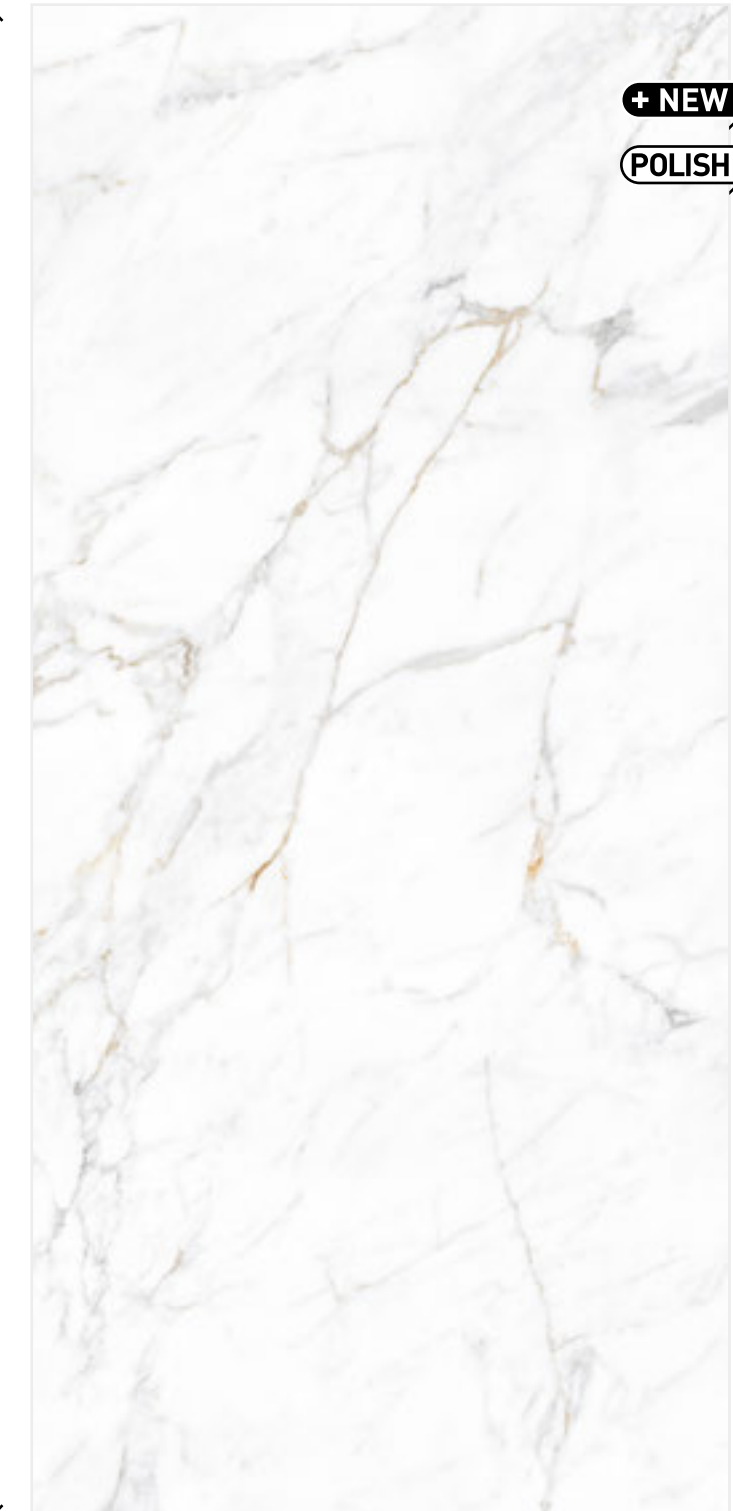

260x120 Porcelânico

L80/120

Série: Arabesko Silver - Polido

Ref.: RLM120260ARASIL



5 606779 229830



Porcelânico Esmaltado  
Glazed tiles, Grès cérame émaillé,  
Feinsteinzeug Glasiert, Porcelánico esmaltado



Retificado  
Rectified / Rectifié / Verarbeitet / Rectificado



Pisos e Paredes  
Floor and Walls / Sol et Mur  
Wandfliesen und Bodenfliesen / Pisos y Paredes



Varição Média V3  
Average tone variation / Variation moyenne  
Durchschnittliche Tonhöhenchwankung  
Variación media de tono



Resistente ao gelo  
Frost resistant / Résistant au gel  
Frostbeständig / Resistente al hielo



Espessura  
Thickness / Épaisseur / Dicke / Grosor



Recomendamos o uso de niveladores  
Recommended levelers / craisillons auto-nivellants conseillé  
Empfohlene Richtmaschinen / Niveladores recomendados



1 Pcs  
3,12 m<sup>2</sup>  
45,50 Kg



21 Pcs  
65,52 m<sup>2</sup>  
956 Kg

Caixa de embalagem de Láminas  
até 21pcs/cx - C200/280, ref.: CXLAM.

## Calacatta Sun

2,60 m

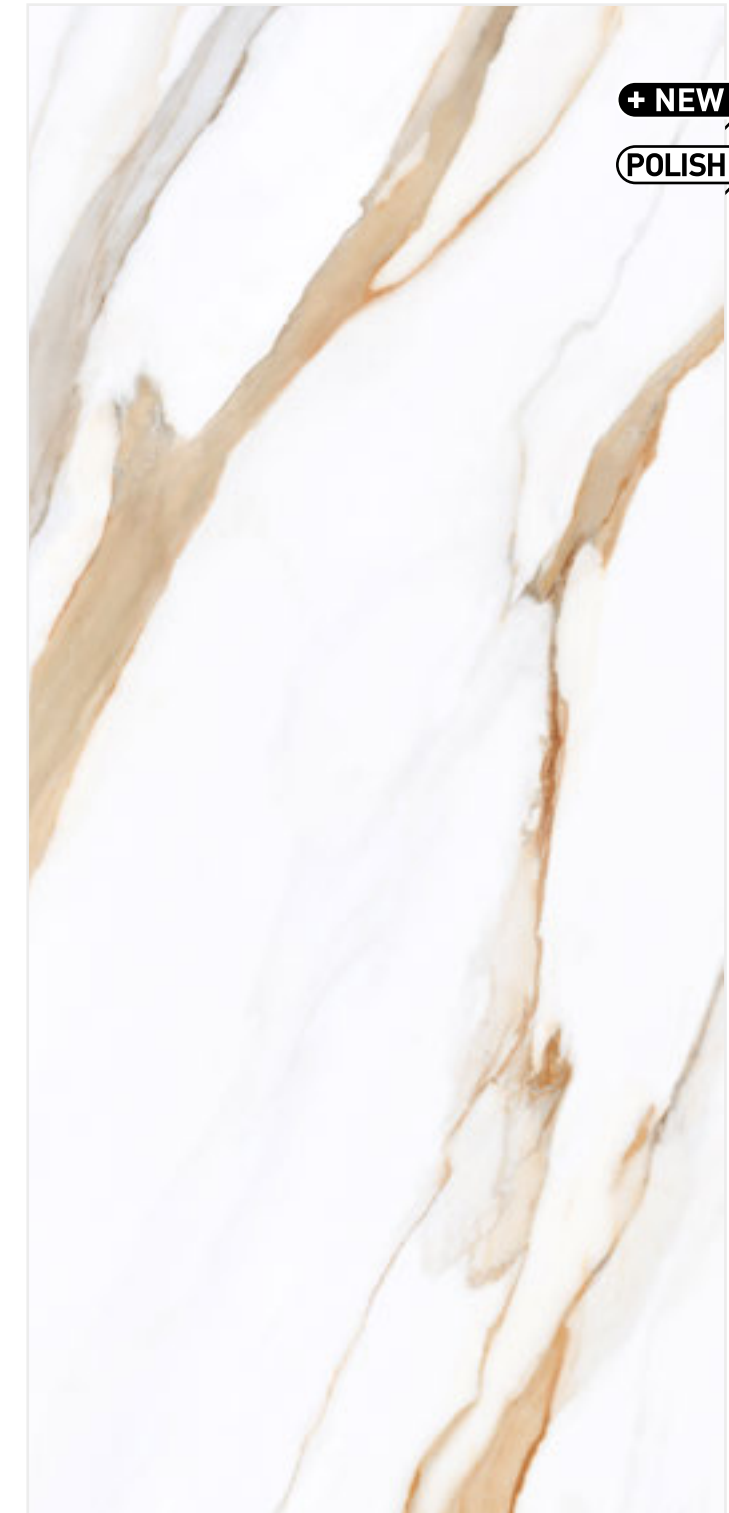

260x120 Porcelânico

L80/120

Série: Calacatta Sun - Polido

Ref.: RLM120260CALSU



5 606779 229670





Porcelânico Esmaltado  
Glazed tiles, Grès cérame émaillé,  
Feinsteinzeug Glasiert, Porcelánico esmaltado



Retificado  
Rectified / Rectifié / Verarbeitet / Rectificado



Pisos e Paredes  
Floor and Walls / Sol et Mur  
Wandfliesen und Bodenfliesen / Pisos y Paredes



Variação Média V3  
Average tone variation / Variation moyenne  
Durchschnittliche Tonhöhenchwankung  
Variación media de tono



Resistente ao gelo  
Frost resistant / Résistant au gel  
Frostbeständig / Resistente al hielo



Espessura  
Thickness / Épaisseur / Dicke / Grosor



Recomendamos o uso de niveladores  
Recommended levelers / craisillons auto-nivellants conseillé  
Empfohlene Richtmaschinen / Niveladores recomendados



PCS  
1 Pcs  
3,12 m<sup>2</sup>  
45,50 Kg



PAL  
21 Pcs  
65,52 m<sup>2</sup>  
956 Kg

Caixa de embalagem de Láminas  
até 21pçs/cx - C200/280, ref.: CXLAM.

## Flam Gold

2,60 m



+ NEW

POLISH

260x120 Porcelânico

L80/120

Série: **Flam Gold - Polido**

Ref.: RLM120260FLAGO



5 606779 229724





Rust



Porcelânico Esmaltado  
Glazed tiles, Grès cérame émaillé,  
Feinsteinzeug Glasiert, Porcelánico esmaltado



Retificado  
Rectified / Rectifié / Verarbeitet / Rectificado



Pisos e Paredes  
Floor and Walls / Sol et Mur  
Wandfliesen und Bodenfliesen / Pisos y Paredes



Variação Média V3  
Average tone variation / Variation moyenne  
Durchschnittliche Tonhöhenchwankung  
Variación media de tono



Resistente ao gelo  
Frost resistant / Résistant au gel  
Frostbeständig / Resistente al hielo



Espessura  
Thickness / Épaisseur / Dicke / Grosor

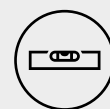

Recomendamos o uso de niveladores  
Recommended levelers / craisillons auto-nivellants conseillé  
Empfohlene Richtmaschinen / Niveladores recomendados



PCS

1 Pcs  
3,12 m<sup>2</sup>  
45,50 Kg



PAL

21 Pcs  
65,52 m<sup>2</sup>  
956 Kg

2,60 m



260x120 Porcelânico

L80/120

Série: Rust - Polido

Ref.: RLM12026ORUST



5 606779 229687

Caixa de embalagem de Láminas  
até 21pcs/cx - C200/280, ref.: CXLAM.





Porcelânico Esmaltado  
Glazed tiles, Grès cérame émaillé,  
Feinsteinzeug Glasiert, Porcelánico esmaltado



Retificado  
Rectified / Rectifié / Verarbeitet / Rectificado



Pisos e Paredes  
Floor and Walls / Sol et Mur  
Wandfliesen und Bodenfliesen / Pisos y Paredes



Varição Média V3  
Average tone variation / Variation moyenne  
Durchschnittliche Tonhöhenchwankung  
Variación media de tono



Resistente ao gelo  
Frost resistant / Résistant au gel  
Frostbeständig / Resistente al hielo



Espessura  
Thickness / Épaisseur / Dicke / Grosor

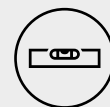

Recomendamos o uso de niveladores  
Recommended levelers / craisillons auto-nivellants conseillé  
Empfohlene Richtmaschinen / Niveladores recomendados



PCS  
1 Pcs  
3,12 m<sup>2</sup>  
45,50 Kg



PAL  
21 Pcs  
65,52 m<sup>2</sup>  
956 Kg

Caixa de embalagem de Láminas  
até 21pcs/cx - C200/280, ref.: CXLAM.

## Sarona Night

2,60 m



260x120 Porcelânico

L80/120

Série: Sarona Night - Polido

Ref.: RLM120260SARNIG



5 606779 229779





PE

Porcelânico Esmaltado  
Glazed tiles, Grès cérame émaillé,  
Feinsteinzeug Glasiert, Porcelánico esmaltado

RET

Retificado  
Rectified / Rectifié / Verarbeitet / Rectificado



Pisos e Paredes  
Floor and Walls / Sol et Mur  
Wandfliesen und Bodenfliesen / Pisos y Paredes



Variação Média V3  
Average tone variation / Variation moyenne  
Durchschnittliche Tonhöhen schwankung  
Variación media de tono



Resistente ao gelo  
Frost resistant / Résistant au gel  
Frostbeständig / Resistente al hielo



6 mm  
Espessura  
Thickness / Épaisseur / Dicke / Grosor



Recomendamos o uso de niveladores  
Recommended levelers / craisillons auto-nivellants conseillé  
Empfohlene Richtmaschinen / Niveladores recomendados

PCS

1 Pcs  
3,12 m<sup>2</sup>  
45,50 Kg

PAL

21 Pcs  
65,52 m<sup>2</sup>  
956 Kg

Caixa de embalagem de Lâminas  
até 21pcs/cx - C200/280, ref.: CXLAM.

## Canon Grey

2,60 m



260x120 Porcelânico

L80/120

Série: **Canon Grey - Polido**

Ref.: RLM120260CANGRE



5 606779 229694





Porcelânico Esmaltado  
Glazed tiles, Grès cérame émaillé,  
Feinsteinzeug Glasiert, Porcelánico esmaltado



Retificado  
Rectified / Rectifié / Verarbeitet / Rectificado



Pisos e Paredes  
Floor and Walls / Sol et Mur  
Wandfliesen und Bodenfliesen / Pisos y Paredes



Variação Média V3  
Average tone variation / Variation moyenne  
Durchschnittliche Tonhöhenchwankung  
Variación media de tono



Resistente ao gelo  
Frost resistant / Résistant au gel  
Frostbeständig / Resistente al hielo



Espessura  
Thickness / Épaisseur / Dicke / Grosor

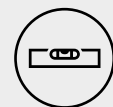

Recomendamos o uso de niveladores  
Recommended levelers / craisillons auto-nivellants conseillé  
Empfohlene Richtmaschinen / Niveladores recomendados



PCS

1 Pcs  
3,12 m<sup>2</sup>  
45,50 Kg



PAL

21 Pcs  
65,52 m<sup>2</sup>  
956 Kg

Caixa de embalagem de Lâminas  
até 21pcs/cx - C200/280, ref.: CXLAM.

## Verde Alpi

2,60 m

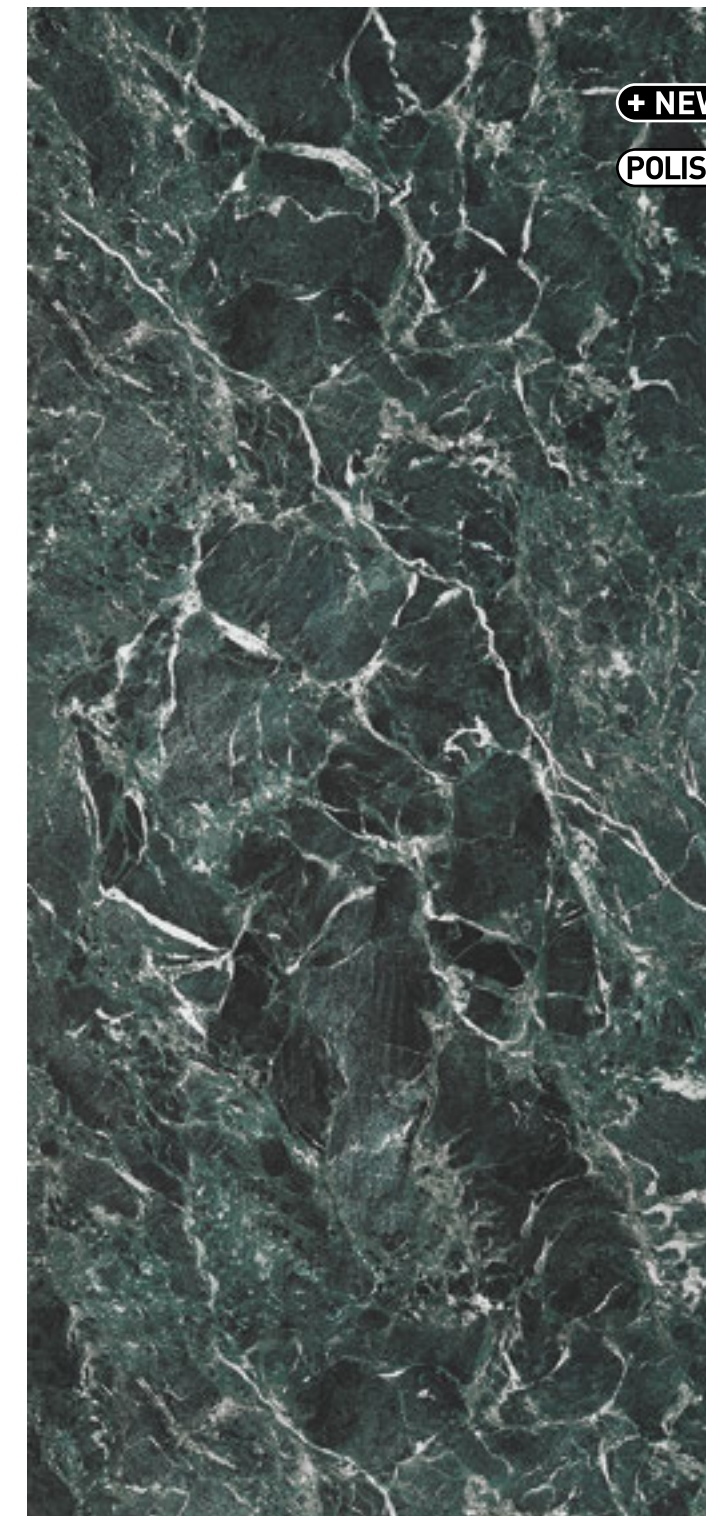

260x120 Porcelânico

L80/120

Série: Verde Alpi - Polido

Ref.: RLM120260VEAP



5 606779 250193





Porcelânico Esmaltado  
Glazed tiles, Grès cérame émaillé,  
Feinsteinzeug Glasiert, Porcelánico esmaltado



Retificado  
Rectified / Rectifié / Verarbeitet / Rectificado



Pisos e Paredes  
Floor and Walls / Sol et Mur  
Wandfliesen und Bodenfliesen / Pisos y Paredes



Varição Média V3  
Average tone variation / Variation moyenne  
Durchschnittliche Tonhöhenchwankung  
Variación media de tono



Resistente ao gelo  
Frost resistant / Résistant au gel  
Frostbeständig / Resistente al hielo



Espessura  
Thickness / Épaisseur / Dicke / Grosor



Recomendamos o uso de niveladores  
Recommended levelers / craisillons auto-nivellants conseillé  
Empfohlene Richtmaschinen / Niveladores recomendados



1 Pcs  
3,12 m<sup>2</sup>  
45,50 Kg



21 Pcs  
65,52 m<sup>2</sup>  
956 Kg

Caixa de embalagem de Lâminas  
até 21pcs/cx - C200/280, ref.: CXLAM.

# Amazonite

2,60 m

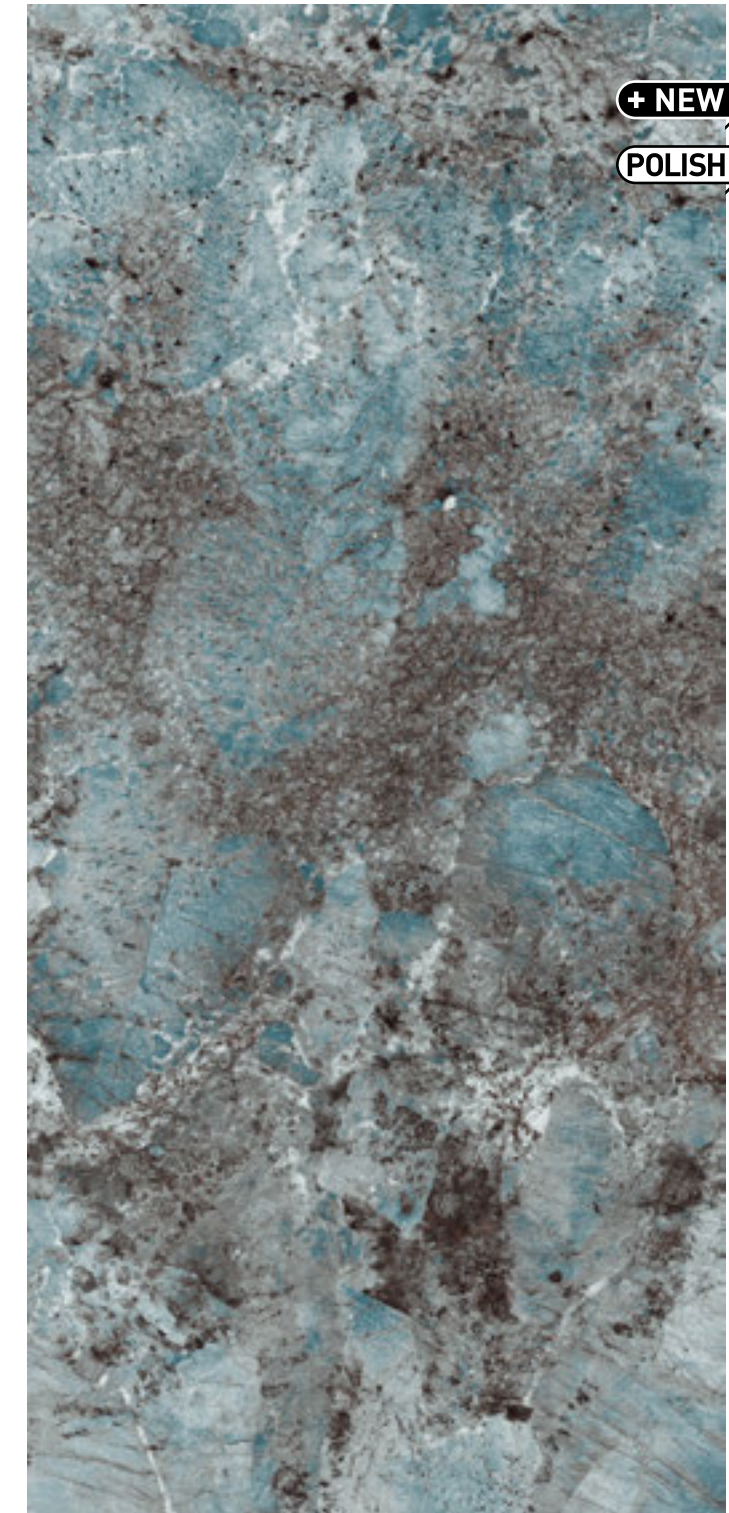

260x120 Porcelânico

L80/120

Série: **Amazonite - Polido**

Ref.: RLM260120AMZP



5 606779 251886





# Onyx



Porcelânico Esmaltado  
Glazed tiles, Grès cérame émaillé,  
Feinsteinzeug Glasiert, Porcelánico esmaltado



Retificado  
Rectified / Rectifié / Verarbeitet / Rectificado



Pisos e Paredes  
Floor and Walls / Sol et Mur  
Wandfliesen und Bodenfliesen / Pisos y Paredes



Variação Média V3  
Average tone variation / Variation moyenne  
Durchschnittliche Tonhöhen schwankung  
Variación media de tono



Resistente ao gelo  
Frost resistant / Résistant au gel  
Frostbeständig / Resistente al hielo



Espessura  
Thickness / Épaisseur / Dicke / Grosor



Recomendamos o uso de niveladores  
Recommended levelers / craisillons auto-nivellants conseillé  
Empfohlene Richtmaschinen / Niveladores recomendados



1 Pcs  
3,12 m<sup>2</sup>  
45,50 Kg



21 Pcs  
65,52 m<sup>2</sup>  
956 Kg

2,60 m



260x120 Porcelânico

L80/120

Série: **Onyx - Polido**

Ref.: RLM260120ONP



Caixa de embalagem de Lâminas  
até 21pcs/cx - C200/280, ref.: CXLAM.





PE

Porcelânico Esmaltado  
Glazed tiles, Grès cérame émaillé,  
Feinsteinzeug Glasiert, Porcelánico esmaltado

RET

Retificado  
Rectified / Rectifié / Verarbeitet / Rectificado



Pisos e Paredes  
Floor and Walls / Sol et Mur  
Wandfliesen und Bodenfliesen / Pisos y Paredes



Variação Média V3  
Average tone variation / Variation moyenne  
Durchschnittliche Tonhöhenchwankung  
Variación media de tono



Resistente ao gelo  
Frost resistant / Résistant au gel  
Frostbeständig / Resistente al hielo



Espessura  
Thickness / Épaisseur / Dicke / Grosor



Recomendamos o uso de niveladores  
Recommended levelers / craisillons auto-nivellants conseillé  
Empfohlene Richtmaschinen / Niveladores recomendados

PCS

1 Pcs  
3,12 m<sup>2</sup>  
45,50 Kg

PAL

21 Pcs  
65,52 m<sup>2</sup>  
956 Kg

Caixa de embalagem de Láminas  
até 21pcs/cx - C200/280, ref.: CXLAM.

Iceberg

2,60 m

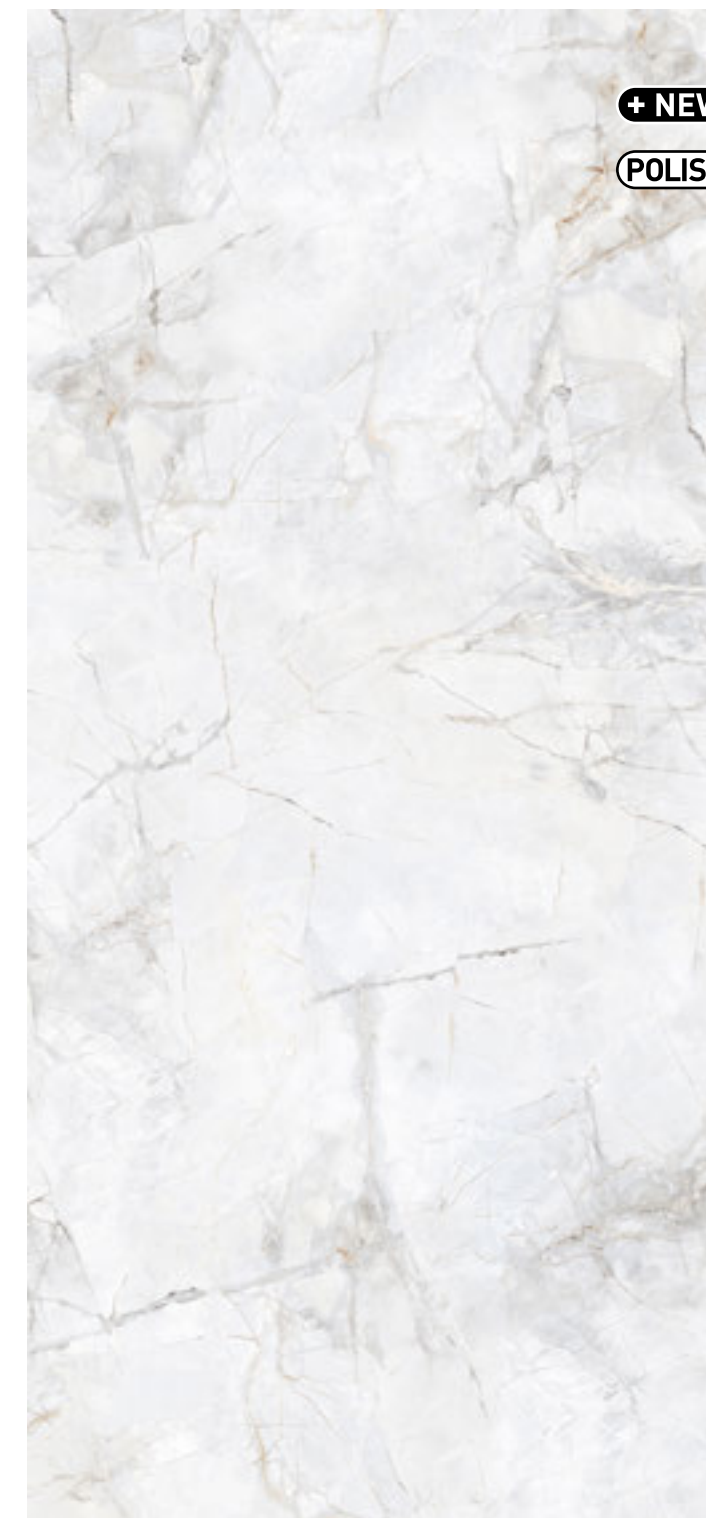

260x120 Porcelânico

L80/120

Série: Iceberg - Polido

Ref.: RLM260120ICBP



5 606779 251909





Porcelânico Esmaltado  
Glazed tiles, Grès cérame émaillé,  
Feinsteinzeug Glasiert, Porcelánico esmaltado



Retificado  
Rectified / Rectifié / Verarbeitet / Rectificado



Pisos e Paredes  
Floor and Walls / Sol et Mur  
Wandfliesen und Bodenfliesen / Pisos y Paredes



Variação Média V3  
Average tone variation / Variation moyenne  
Durchschnittliche Tonhöhenchwankung  
Variación media de tono



Resistente ao gelo  
Frost resistant / Résistant au gel  
Frostbeständig / Resistente al hielo



Espessura  
Thickness / Épaisseur / Dicke / Grosor



Recomendamos o uso de niveladores  
Recommended levelers / croisillons auto-nivellants conseillé  
Empfohlene Richtmaschinen / Niveladores recomendados



PCS  
1 Pcs  
3,12 m<sup>2</sup>  
45,50 Kg



PAL  
21 Pcs  
65,52 m<sup>2</sup>  
956 Kg

Caixa de embalagem de Láminas  
até 21pcs/cx - C200/280, ref.: CXLAM.

## Onyx Oceano

2,60 m

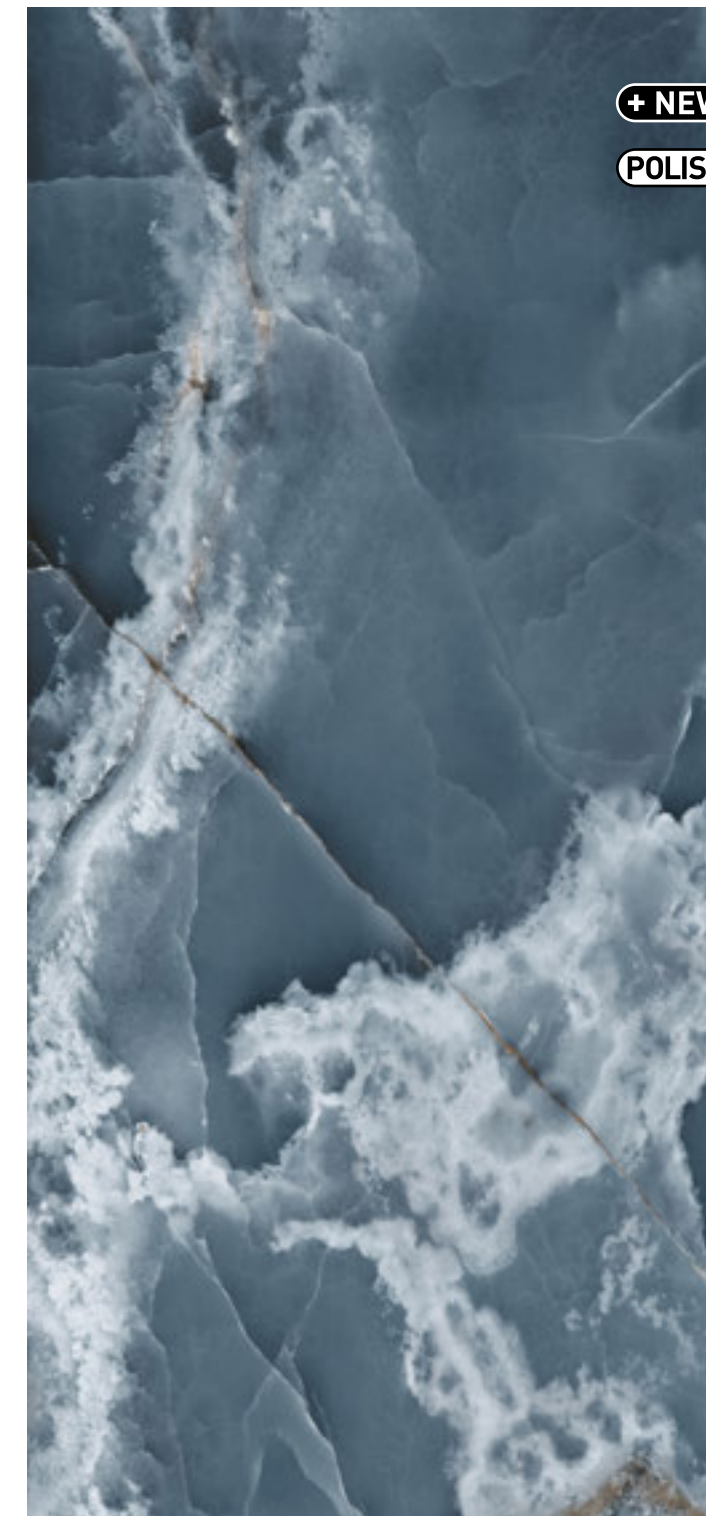

260x120 Porcelânico

L80/120

Série: **Onyx Oceano - Polido**

Ref.: RLM260120ONYOCP



5 606779 251916





## Patagonia Bianco

2,60 m



Porcelánico Esmaltado  
Glazed tiles / Grès cérame émaillé,  
Feinsteinzeug Glasier, Porcelánico esmaltado



Retificado  
Rectified / Rectifié / Verarbeitet / Rectificado



Pisos e Paredes  
Floor and Walls / Sol et Mur  
Wandfliesen und Bodenfliesen / Pisos y Paredes



Variação Média V3  
Average tone variation / Variation moyenne  
Durchschnittliche Tonhöhenchwankung  
Variación media de tono



Resistente ao gelo  
Frost resistant / Résistant au gel  
Frostbeständig / Resistente al hielo



Espessura  
Thickness / Épaisseur / Dicke / Grosor



Recomendamos o uso de niveladores  
Recommended levelers / craisillons auto-nivellants conseillé  
Empfohlene Richtmaschinen / Niveladores recomendados



PCS  
1 Pcs  
3,12 m<sup>2</sup>  
45,50 Kg



PAL  
21 Pcs  
65,52 m<sup>2</sup>  
956 Kg

Caixa de embalagem de Lâminas  
até 21pcs/cx - C200/280, ref.: CXLAM.

+ NEW

POLISH



260x120 Porcelânico

L80/120

Série: **Patagonia Bianco - Polido**

Ref.: RLM260120PATB



5 606779 251923





## Pietra Nero



Porcelânico Esmaltado  
Glazed tiles, Grès cérame émaillé,  
Feinsteinzeug Glasiert, Porcelánico esmaltado



Retificado  
Rectified / Rectifié / Verarbeitet / Rectificado



Pisos e Paredes  
Floor and Walls / Sol et Mur  
Wandfliesen und Bodenfliesen / Pisos y Paredes



Variação Média V3  
Average tone variation / Variation moyenne  
Durchschnittliche Tonhöhen schwankung  
Variación media de tono



Resistente ao gelo  
Frost resistant / Résistant au gel  
Frostbeständig / Resistente al hielo



Espessura  
Thickness / Épaisseur / Dicke / Grosor



Recomendamos o uso de niveladores  
Recommended levelers / craisillons auto-nivellants conseillé  
Empfohlene Richtmaschinen / Niveladores recomendados



1 Pcs  
3,12 m<sup>2</sup>  
45,50 Kg



21 Pcs  
65,52 m<sup>2</sup>  
956 Kg

2,60 m



+ NEW

POLISH



260x120 Porcelânico

L80/120

Série: **Pietra Nero - Polido**

Ref.: RLM260120PIEBLP



Caixa de embalagem de Lâminas  
até 21pcs/cx - C200/280, ref.: CXLAM.





Porcelânico Esmaltado  
Glazed tiles, Grès cérame émaillé,  
Feinsteinzeug Glasiert, Porcelánico esmaltado



Retificado  
Rectified / Rectifié / Verarbeitet / Rectificado



Pisos e Paredes  
Floor and Walls / Sol et Mur  
Wandfliesen und Bodenfliesen / Pisos y Paredes



Variação Média V3  
Average tone variation / Variation moyenne  
Durchschnittliche Tonhöhenschwankung  
Variación media de tono



Resistente ao gelo  
Frost resistant / Résistant au gel  
Frostbeständig / Resistente al hielo



Espessura  
Thickness / Épaisseur / Dicke / Grosor



Recomendamos o uso de niveladores  
Recommended levelers / craisillons auto-nivellants conseillé  
Empfohlene Richtmaschinen / Niveladores recomendados



1 Pcs  
3,12 m<sup>2</sup>  
45,50 Kg



21 Pcs  
65,52 m<sup>2</sup>  
956 Kg

Caixa de embalagem de Láminas  
até 21pcs/cx - C200/280, ref.: CXLAM.

# Marfil Gold

2,60 m

+ NEW

POLISH



260x120 Porcelânico

L80/120

Série: **Marfil Gold - Polido**

Ref.: RLM260120MARGOP



5 606779 251961





Porcelânico Esmaltado  
Glazed tiles / Grès cérame émaillé,  
Feinsteinzeug Glasiert, Porcelánico esmaltado



Retificado  
Rectified / Rectifié / Verarbeitet / Rectificado



Pisos e Paredes  
Floor and Walls / Sol et Mur  
Wandfliesen und Bodenfliesen / Pisos y Paredes



Varição Média V3  
Average tone variation / Variation moyenne  
Durchschnittliche Tonhöhenchwankung  
Variación media de tono



Resistente ao gelo  
Frost resistant / Résistant au gel  
Frostbeständig / Resistente al hielo



6 mm  
Espessura  
Thickness / Épaisseur / Dicke / Grosor



Recomendamos o uso de niveladores  
Recommended levelers / craisillons auto-nivellants conseillé  
Empfohlene Richtmaschinen / Niveladores recomendados



1 Pcs  
3,12 m<sup>2</sup>  
45,50 Kg



21 Pcs  
65,52 m<sup>2</sup>  
956 Kg

Caixa de embalagem de Lâminas  
até 21pcs/cx - C200/280, ref.: CXLAM.

2,60 m

## Silver Root

+ NEW

POLISH

MATE



260x120 Porcelânico

L80/120

Série: **Silver Root - Polido**

Ref.: RLM260120SILROP



5 606779 251947

260x120 Porcelânico

L75/105

Série: **Silver Root - Mate**

Ref.: RLM260120SILROMT



5 606779 252005





PE

Porcelânico Esmaltado  
Glazed tiles / Grès cérame émaillé,  
Feinsteinzeug Glasiert, Porcelánico esmaltado

RET

Retificado  
Rectified / Rectifié / Verarbeitet / Rectificado

Pisos e Paredes  
Floor and Walls / Sol et Mur  
Wandfliesen und Bodenfliesen / Pisos y Paredes

Variação Média V3  
Average tone variation / Variation moyenne  
Durchschnittliche Tonhöhenchwankung  
Variación media de tono

Resistente ao gelo  
Frost resistant / Résistant au gel  
Frostbeständig / Resistente al hielo

Espessura  
Thickness / Épaisseur / Dicke / Grosor

Recomendamos o uso de niveladores  
Recommended levelers / craisillons auto-nivellants conseillé  
Empfohlene Richtmaschinen / Niveladores recomendados

PCS

1 Pcs  
3,12 m<sup>2</sup>  
45,50 Kg

PAL

21 Pcs  
65,52 m<sup>2</sup>  
956 Kg

Caixa de embalagem de Lâminas  
até 21pcs/cx - C200/280, ref.: CXLAM.

## Calacatta Bellissimo

2,60 m

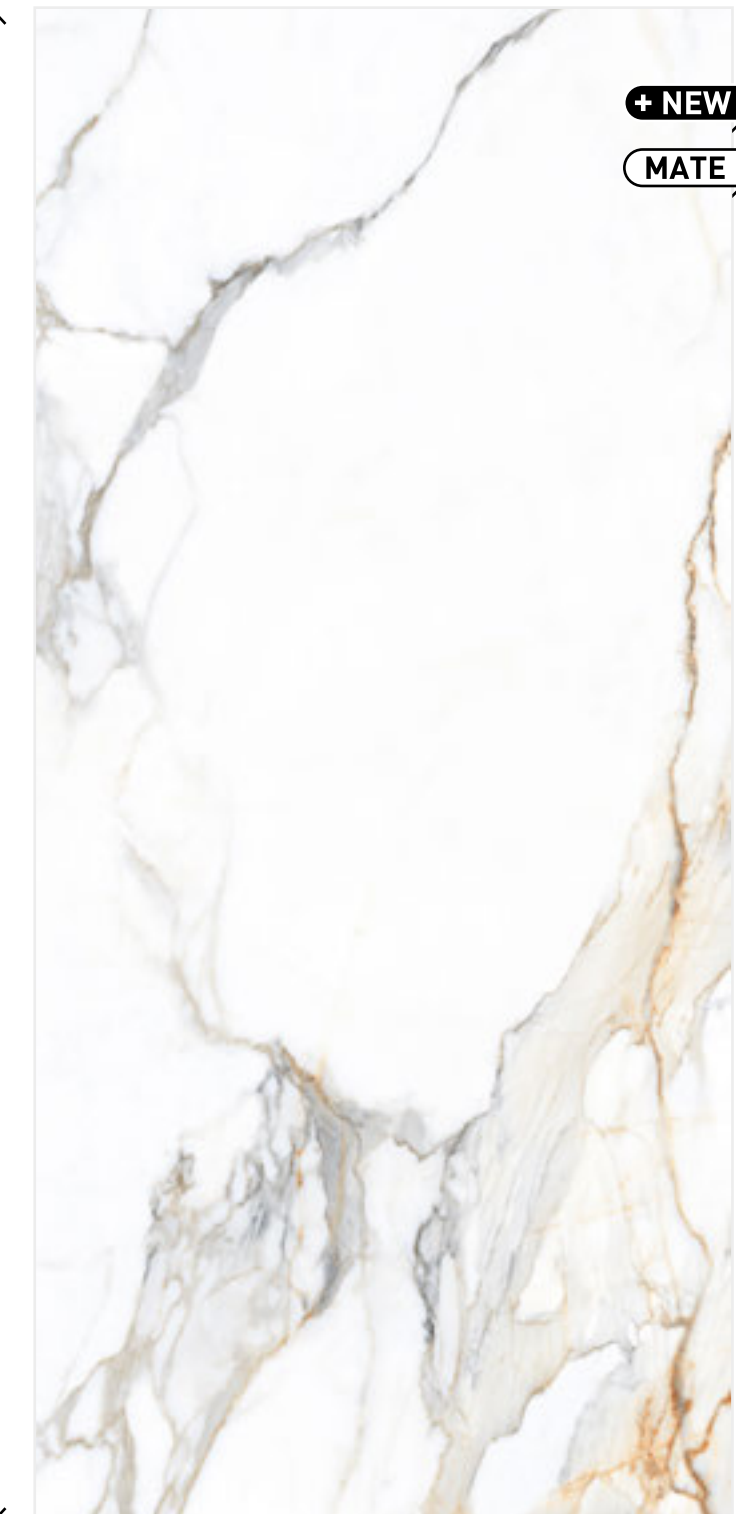

+ NEW

MATE

260x120 Porcelânico

L75/105

Série: Calacatta Bellissimo - Mate

Ref.: RLM260120CALBM



5 606779 251954





Porcelânico Esmaltado  
Glazed tiles, Grès cérame émaillé,  
Feinsteinzeug Glasiert, Porcelánico esmaltado



Retificado  
Rectified / Rectifié / Verarbeitet / Rectificado



Pisos e Paredes  
Floor and Walls / Sol et Mur  
Wandfliesen und Bodenfliesen / Pisos y Paredes



Varição Média V3  
Average tone variation / Variation moyenne  
Durchschnittliche Tonhöhenchwankung  
Variación media de tono



Resistente ao gelo  
Frost resistant / Résistant au gel  
Frostbeständig / Resistente al hielo



Espessura  
Thickness / Épaisseur / Dicke / Grosor



Recomendamos o uso de niveladores  
Recommended levelers / croisillons auto-nivellants conseillé  
Empfohlene Richtmaschinen / Niveladores recomendados



PCS  
1 Pcs  
3,12 m<sup>2</sup>  
45,50 Kg



PAL  
21 Pcs  
65,52 m<sup>2</sup>  
956 Kg

Caixa de embalagem de Láminas  
até 21pcs/cx - C200/280, ref.: CXLAM.

## Terrazzo Grey

2,60 m



260x120 Porcelânico

L75/105

Série: **Terrazzo Grey - Mate**

Ref.: RLM260120TERGRM



5 606779 251978





PE

Porcelânico Esmaltado  
Glazed tiles, Grès cérame émaillé,  
Feinsteinzeug Glasiert, Porcelánico esmaltado

RET

Retificado  
Rectified / Rectifié / Verarbeitet / Rectificado



Pisos e Paredes  
Floor and Walls / Sol et Mur  
Wandfliesen und Bodenfliesen / Pisos y Paredes



Varição Média V3  
Average tone variation / Variation moyenne  
Durchschnittliche Tonhöhenchwankung  
Variación media de tono



Resistente ao gelo  
Frost resistant / Résistant au gel  
Frostbeständig / Resistente al hielo



Espessura  
Thickness / Épaisseur / Dicke / Grosor



Recomendamos o uso de niveladores  
Recommended levelers / craisillons auto-nivellants conseillé  
Empfohlene Richtmaschinen / Niveladores recomendados

PCS

1 Pcs  
3,12 m<sup>2</sup>  
45,50 Kg

PAL

21 Pcs  
65,52 m<sup>2</sup>  
956 Kg

Caixa de embalagem de Lâminas  
até 21pcs/cx - C200/280, ref.: CXLAM.

## Stone Glacier

2,60 m

+ NEW

MATE



260x120 Porcelânico

L75/105

Série: Stone Glacier - Mate

Ref.: RLM120260GLA



5 606779 229793





Porcelânico Esmaltado  
Glazed tiles, Grès cérame émaillé,  
Feinsteinzeug Glasiert, Porcelánico esmaltado



Retificado  
Rectified / Rectifié / Verarbeitet / Rectificado



Pisos e Paredes  
Floor and Walls / Sol et Mur  
Wandfliesen und Bodenfliesen / Pisos y Paredes



Variação Média V3  
Average tone variation / Variation moyenne  
Durchschnittliche Tonhöhenchwankung  
Variación media de tono



Resistente ao gelo  
Frost resistant / Résistant au gel  
Frostbeständig / Resistente al hielo



Espessura  
Thickness / Épaisseur / Dicke / Grosor



Recomendamos o uso de niveladores  
Recommended levelers / craillons auto-nivellants conseillé  
Empfohlene Richtmaschinen / Niveladores recomendados



PCS

1 Pcs  
3,12 m<sup>2</sup>  
45,50 Kg



PAL

21 Pcs  
65,52 m<sup>2</sup>  
956 Kg

Caixa de embalagem de Láminas  
até 21pcs/cx - C200/280, ref.: CXLAM.

## Travertino Navona

2,60 m

+ NEW

MATE



260x120 Porcelânico

L75/105

Série: Trav. Navona Griggio - Mate

Ref.: RTN120270GRINAT



5 606779 251152





PE

Porcelânico Esmaltado  
Glazed tiles, Grès cérame émaillé,  
Feinsteinzeug Glasiert, Porcelánico esmaltado

RET

Retificado  
Rectified / Rectifié / Verarbeitet / Rectificado



Pisos e Paredes  
Floor and Walls / Sol et Mur  
Wandfliesen und Bodenfliesen / Pisos y Paredes



Variação Média V3  
Average tone variation / Variation moyenne  
Durchschnittliche Tonhöhenchwankung  
Variación media de tono



Resistente ao gelo  
Frost resistant / Résistant au gel  
Frostbeständig / Resistente al hielo



Espessura  
Thickness / Épaisseur / Dicke / Grosor

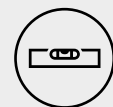

Recomendamos o uso de niveladores  
Recommended levelers / craisillons auto-nivellants conseillé  
Empfohlene Richtmaschinen / Niveladores recomendados



PCS

1 Pcs  
3,12 m<sup>2</sup>  
45,50 Kg



PAL

21 Pcs  
65,52 m<sup>2</sup>  
956 Kg

Caixa de embalagem de Lâminas  
até 21pcs/cx - C200/280, ref.: CXLAM.

## Travertino Navona

2,60 m

+ NEW

MATE



260x120 Porcelânico

L75/105

Série: Trav. Navona Bianco - Mate

Ref.: RTN120270BIANAT



5 606779 251169





Porcelânico Esmaltado  
Glazed tiles, Grès cérame émaillé,  
Feinsteinzeug Glasiert, Porcelánico esmaltado



Retificado  
Rectified / Rectifié / Verarbeitet / Rectificado



Pisos e Paredes  
Floor and Walls / Sol et Mur  
Wandfliesen und Bodenfliesen / Pisos y Paredes



Variação Média V3  
Average tone variation / Variation moyenne  
Durchschnittliche Tonhöhenchwankung  
Variación media de tono



Resistente ao gelo  
Frost resistant / Résistant au gel  
Frostbeständig / Resistente al hielo



Espessura  
Thickness / Épaisseur / Dicke / Grosor



Recomendamos o uso de niveladores  
Recommended levelers / craisillons auto-nivellants conseillé  
Empfohlene Richtmaschinen / Niveladores recomendados



1 Pcs  
3,12 m<sup>2</sup>  
45,50 Kg



21 Pcs  
65,52 m<sup>2</sup>  
956 Kg

Caixa de embalagem de Lâminas  
até 21pcs/cx - C200/280, ref.: CXLAM.

## Oh!Take Forest

2,60 m

**+ NEW**

**MATE**



**HEAVEN**  
ROH120270HEANAT



260x120 Porcelânico

**L75/105**

Série: **Oh!Take Forest - Mate**

Ref.: ROH120270FORNAT



5 606779 292160





Mountain



Clif



City



Porcelânico Esmaltado  
Glazed tiles, Grès cérame émaillé,  
Feinsteinzeug Glasiert, Porcelánico esmaltado



Retificado  
Rectified / Rectifié / Verarbeitet / Rectificado



Pisos e Paredes  
Floor and Walls / Sol et Mur  
Wandfliesen und Bodenfliesen / Pisos y Paredes



Variação Média V3  
Average tone variation / Variation moyenne  
Durchschnittliche Tonhöhenchwankung  
Variación media de tono



Resistente ao gelo  
Frost resistant / Résistant au gel  
Frostbeständig / Resistente al hielo



Espessura  
Thickness / Épaisseur / Dicke / Grosor



Recomendamos o uso de niveladores  
Recommended levelers / craisillons auto-nivellants conseillé  
Empfohlene Richtmaschinen / Niveladores recomendados



PCS  
1 Pcs  
3,12 m<sup>2</sup>  
45,50 Kg



PAL  
21 Pcs  
65,52 m<sup>2</sup>  
956 Kg

Caixa de embalagem de Láminas  
até 21pcs/cx - C200/280, ref.: CXLAM.

## Oh!Take Mountain

2,60 m

+ NEW

MATE



CLIF  
ROH120270CLINAT



CITY  
ROH120270CTYNAT

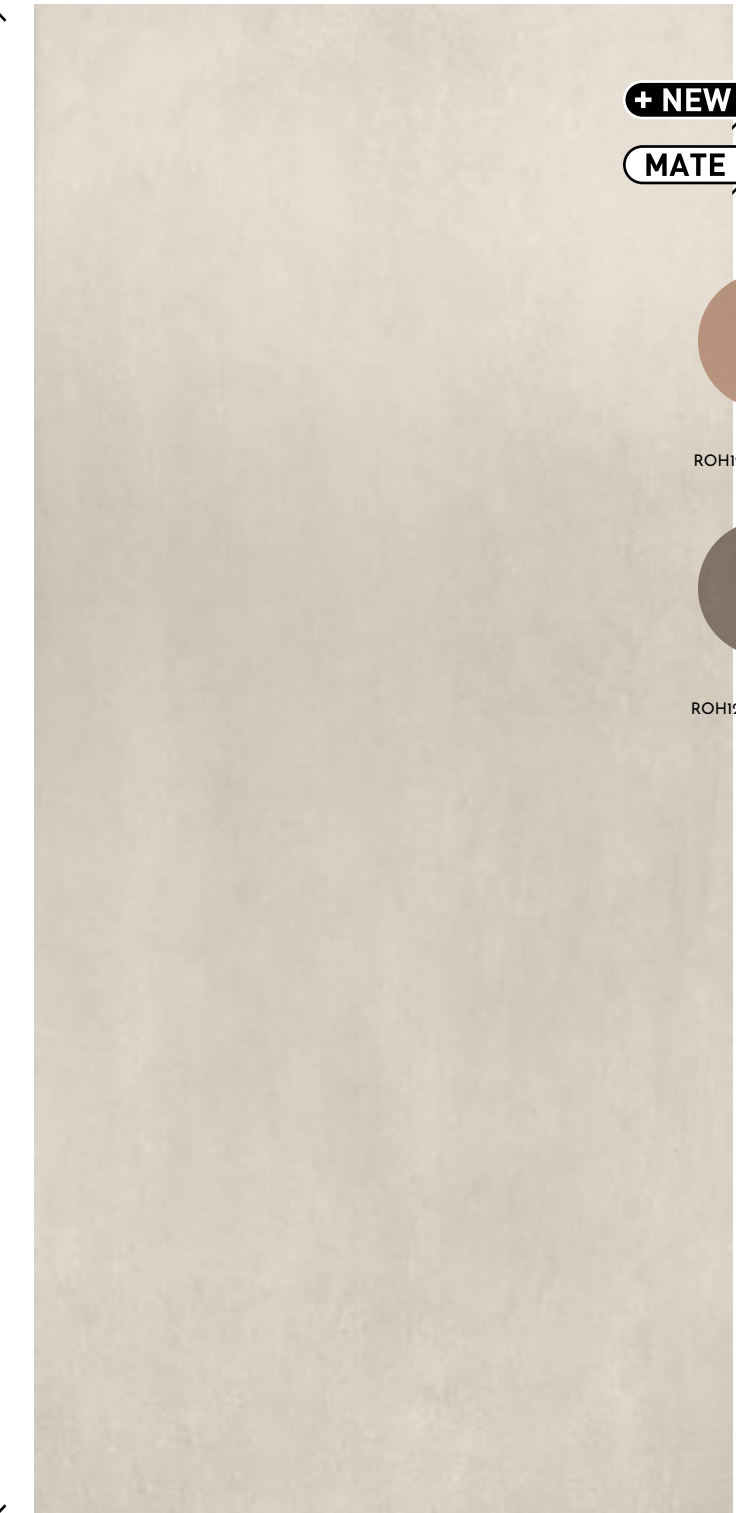

260x120 Porcelânico

L75/105

Série: Oh!Take Mountain - Mate

Ref.: ROH120270MONAT



5 606779 292955





PE

Porcelânico Esmaltado  
Glazed tiles, Grès cérame émaillé,  
Feinsteinzeug Glasiert, Porcelánico esmaltado

RET

Retificado  
Rectified / Rectifié / Verarbeitet / Rectificado



Pisos e Paredes  
Floor and Walls / Sol et Mur  
Wandfliesen und Bodenfliesen / Pisos y Paredes



Variação Média V3  
Average tone variation / Variation moyenne  
Durchschnittliche Tonhöhenchwankung  
Variación media de tono



Resistente ao gelo  
Frost resistant / Résistant au gel  
Frostbeständig / Resistente al hielo



Espessura  
Thickness / Épaisseur / Dicke / Grosor



Recomendamos o uso de niveladores  
Recommended levelers / croisillons auto-nivellants conseillé  
Empfohlene Richtmaschinen / Niveladores recomendados



PCS

1 Pcs  
3,12 m<sup>2</sup>  
45,50 Kg



PAL

21 Pcs  
65,52 m<sup>2</sup>  
956 Kg

Caixa de embalagem de Lâminas  
até 21pcs/cx - C200/280, ref.: CXLAM.

Oh!Take Moon

2,60 m

+ NEW

MATE



HOME  
ROH120270HOMNAT



260x120 Porcelânico

L75/105

Série: Oh!Take Moon - Mate

Ref.: ROH120270MONNAT



5 606779 251145





Porcelânico Esmaltado  
Glazed tiles, Grès cérame émaillé,  
Feinsteinzeug Glasiert, Porcelánico esmaltado



Retificado  
Rectified / Rectifié / Verarbeitet / Rectificado



Pisos e Paredes  
Floor and Walls / Sol et Mur  
Wandfliesen und Bodenfliesen / Pisos y Paredes



Variação Média V3  
Average tone variation / Variation moyenne  
Durchschnittliche Tonhöhen schwankung  
Variación media de tono



Resistente ao gelo  
Frost resistant / Résistant au gel  
Frostbeständig / Resistente al hielo



Espessura  
Thickness / Épaisseur / Dicke / Grosor



Recomendamos o uso de niveladores  
Recommended levelers / croisillons auto-nivellants conseillé  
Empfohlene Richtmaschinen / Niveladores recomendados



1 Pcs  
3,12 m<sup>2</sup>  
45,50 Kg



21 Pcs  
65,52 m<sup>2</sup>  
956 Kg

Caixa de embalagem de Lâminas  
até 21pcs/cx - C200/280, ref.: CXLAM.

# Ivory

2,60 m



260x120 PORCELÂNICO

L80/112

Série: Ivory - Polido

Ref.: RLM120260IVOP



5 606779 218902





Porcelânico Esmaltado  
Glazed tiles, Grès cérame émaillé,  
Feinsteinzeug Glasiert, Porcelánico esmaltado



Retificado  
Rectified / Rectifié / Verarbeitet / Rectificado



Pisos e Paredes  
Floor and Walls / Sol et Mur  
Wandfliesen und Bodenfliesen / Pisos y Paredes



Variação Média V3  
Average tone variation / Variation moyenne  
Durchschnittliche Tonhöhenchwankung  
Variación media de tono



Resistente ao gelo  
Frost resistant / Résistant au gel  
Frostbeständig / Resistente al hielo



Espessura  
Thickness / Épaisseur / Dicke / Grosor

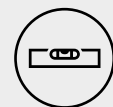

Recomendamos o uso de niveladores  
Recommended levelers / craisillons auto-nivellants conseillé  
Empfohlene Richtmaschinen / Niveladores recomendados



1 Pcs  
3,12 m<sup>2</sup>  
45,50 Kg



21 Pcs  
65,52 m<sup>2</sup>  
956 Kg

Caixa de embalagem de Láminas  
até 21pcs/cx - C200/280, ref.: CXLAM.

## Marmor Grey

2,60 m



260x120 PORCELÂNICO

L80/112

Série: **Marmor Grey - Polido**

Ref.: RLM120260MAGRP



5 606779 218926





Sky

PE

Porcelânico Esmaltado  
Glazed tiles, Grès cérame émaillé,  
Feinsteinzeug Glasierf, Porcelánico esmaltado

RET

Retificado  
Rectified / Rectifié / Verarbeitet / Rectificado



Pisos e Paredes  
Floor and Walls / Sol et Mur  
Wandfliesen und Bodenfliesen / Pisos y Paredes



Varição Média V3  
Average tone variation / Variation moyenne  
Durchschnittliche Tonhöhenchwankung  
Variación media de tono



Resistente ao gelo  
Frost resistant / Résistant au gel  
Frostbeständig / Resistente al hielo



Espessura  
Thickness / Épaisseur / Dicke / Grosor



Recomendamos o uso de niveladores  
Recommended levelers / craisillons auto-nivellants conseillé  
Empfohlene Richtmaschinen / Niveladores recomendados

PCS

1 Pcs  
3,12 m<sup>2</sup>  
45,50 Kg

PAL

21 Pcs  
65,52 m<sup>2</sup>  
956 Kg

2,60 m

POLISH



260x120 PORCELÂNICO

L80/112

Série: Sky - Polido

Ref.: RLM120260SKYP



Caixa de embalagem de Lâminas  
até 21pcs/cx - C200/280, ref.: CXLAM.





PE

Porcelânico Esmaltado  
Glazed tiles, Grès cérame émaillé,  
Feinsteinzeug Glasiert, Porcelánico esmaltado

RET

Retificado  
Rectified / Rectifié / Verarbeitet / Rectificado



Pisos e Paredes  
Floor and Walls / Sol et Mur  
Wandfliesen und Bodenfliesen / Pisos y Paredes



Variação Média V3  
Average tone variation / Variation moyenne  
Durchschnittliche Tonhöhenchwankung  
Variación media de tono



Resistente ao gelo  
Frost resistant / Résistant au gel  
Frostbeständig / Resistente al hielo



Espessura  
Thickness / Épaisseur / Dicke / Grosor



Recomendamos o uso de niveladores  
Recommended levelers / craisillons auto-nivellants conseillé  
Empfohlene Richtmaschinen / Niveladores recomendados



PCS  
1 Pcs  
3,12 m<sup>2</sup>  
45,50 Kg



PAL  
21 Pcs  
65,52 m<sup>2</sup>  
956 Kg

Caixa de embalagem de Lâminas  
até 21pcs/cx - C200/280, ref.: CXLAM.

2,60 m



Indigo

260x120 PORCELÂNICO

L80/112

Série: Indigo - Polido

Ref.: RLM120260ENINP



5 606779 218834





Porcelânico Esmaltado  
Glazed tiles, Grès cérame émaillé,  
Feinsteinzeug Glasier, Porcelánico esmaltado



Retificado  
Rectified / Rectifié / Verarbeitet / Rectificado



Pisos e Paredes  
Floor and Walls / Sol et Mur  
Wandfliesen und Bodenfliesen / Pisos y Paredes



Variação Média V3  
Average tone variation / Variation moyenne  
Durchschnittliche Tonhöhenchwankung  
Variación media de tono



Resistente ao gelo  
Frost resistant / Résistant au gel  
Frostbeständig / Resistente al hielo



Espessura  
Thickness / Épaisseur / Dicke / Grosor

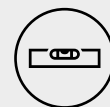

Recomendamos o uso de niveladores  
Recommended levelers / croisillons auto-nivellants conseillé  
Empfohlene Richtmaschinen / Niveladores recomendados



PCS  
1 Pcs  
3,12 m<sup>2</sup>  
45,50 Kg



PAL  
21 Pcs  
65,52 m<sup>2</sup>  
956 Kg

Caixa de embalagem de Lâminas  
até 21pçs/cx - C200/280, ref.: CXLAM.

# Lemurian

2,60 m



260x120 Porcelânico

L80/112

Série: **Lemurian - Polido**

Ref.: R120260LEMUP



5 606779 227300



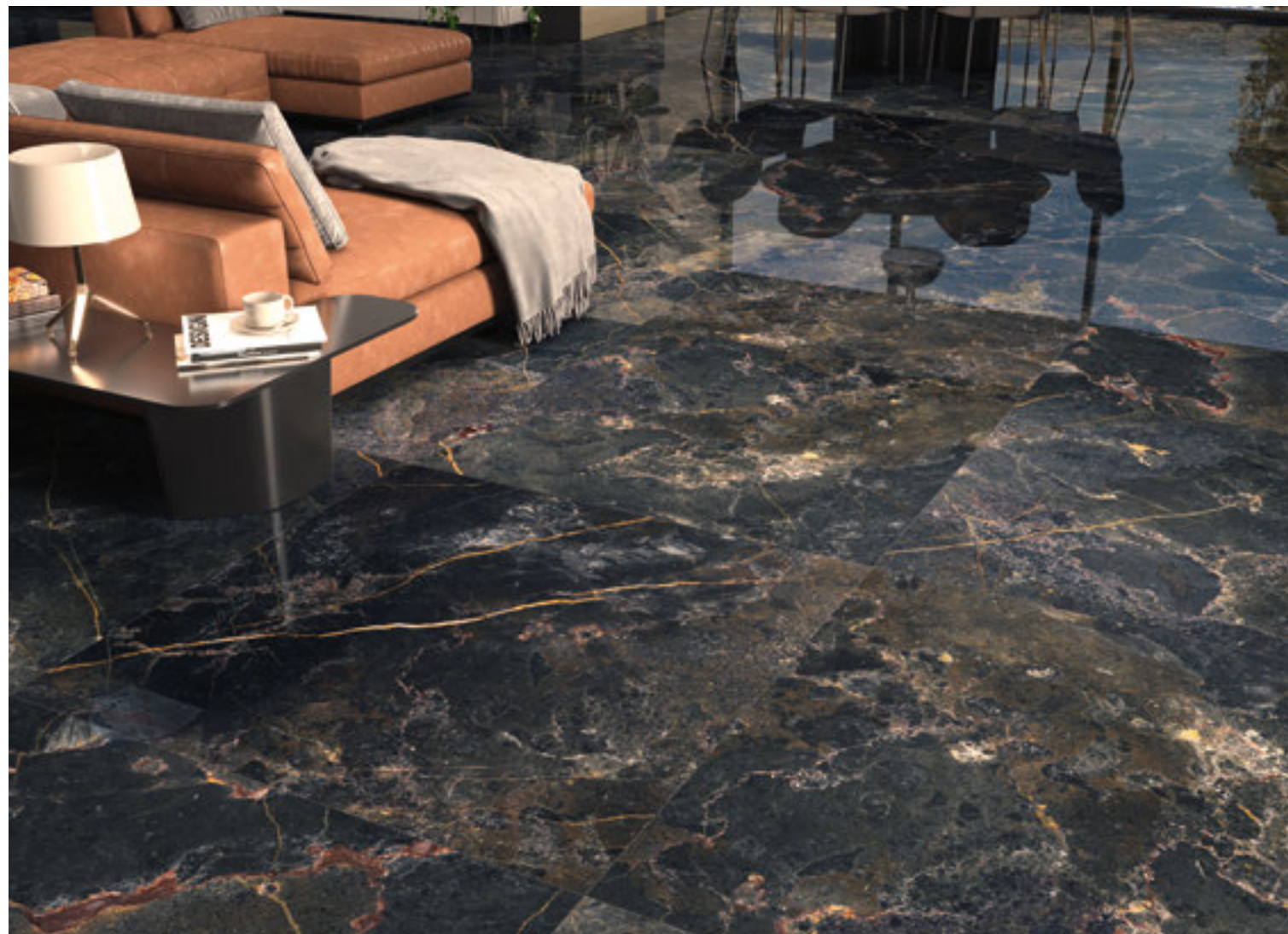

Porcelânico Esmaltado  
Glazed tiles, Grès cérame émaillé,  
Feinsteinzeug Glasier, Porcelánico esmaltado



Retificado  
Rectified / Rectifié / Verarbeitet / Rectificado



Pisos e Paredes  
Floor and Walls / Sol et Mur  
Wandfliesen und Bodenfliesen / Pisos y Paredes



Variação Média V3  
Average tone variation / Variation moyenne  
Durchschnittliche Tonhöhenchwankung  
Variación media de tono



Resistente ao gelo  
Frost resistant / Résistant au gel  
Frostbeständig / Resistente al hielo



Espessura  
Thickness / Épaisseur / Dicke / Grosor



Recomendamos o uso de niveladores  
Recommended levelers / croisillons auto-nivellants conseillé  
Empfohlene Richtmaschinen / Niveladores recomendados



PCS  
1 Pcs  
3,12 m<sup>2</sup>  
45,50 Kg



PAL  
21 Pcs  
65,52 m<sup>2</sup>  
956 Kg

Caixa de embalagem de Lâminas  
até 21pcs/cx - C200/280, ref.: CXLAM.

# Darkness

2,60 m

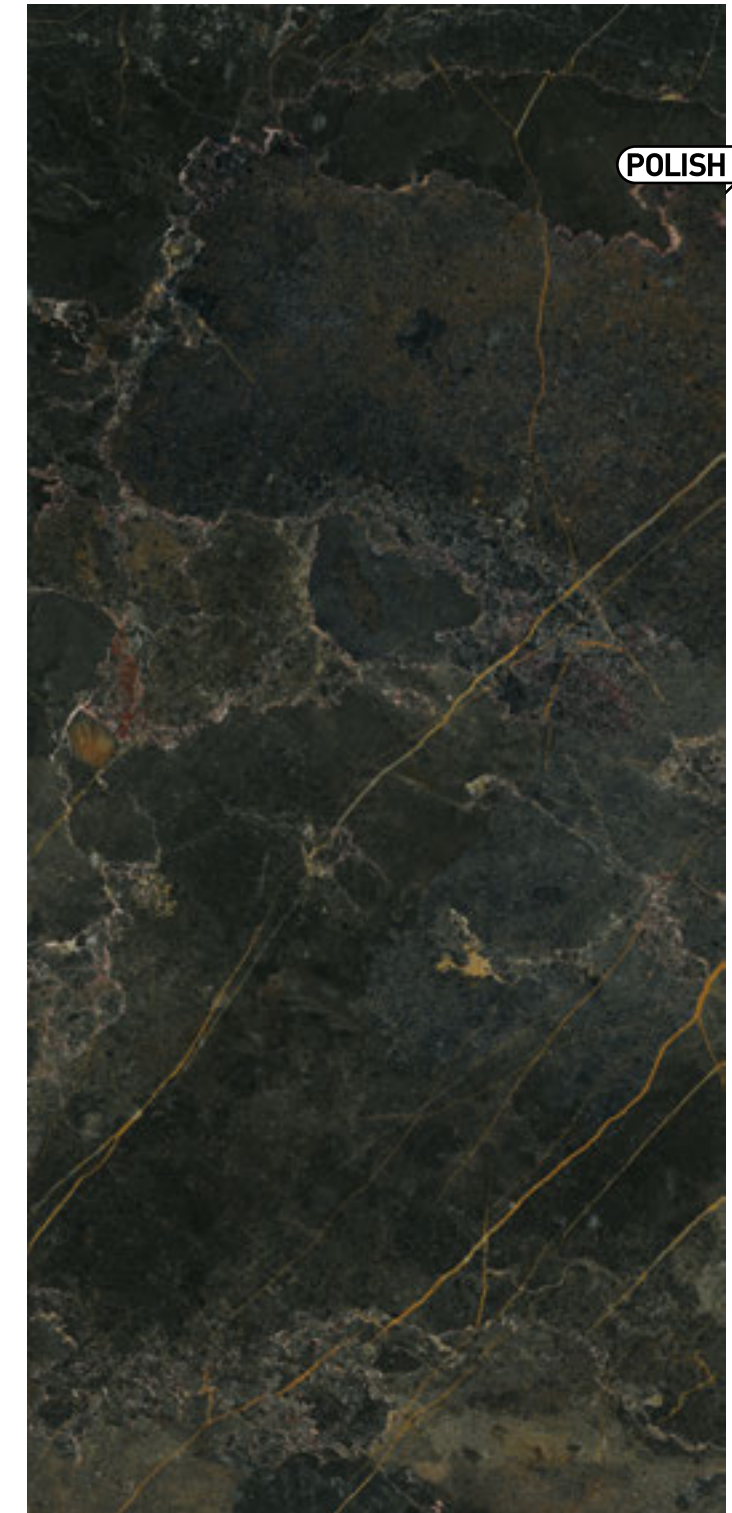

260x120 PORCELÂNICO

L80/112

Série: **Darkness - Polido**

Ref.: RLM120260ENDAP



5 606779 218841





Porcelânico Esmaltado  
Glazed tiles, Grès cérame émaillé,  
Feinsteinzeug Glasiert, Porcelánico esmaltado



Retificado  
Rectified / Rectifié / Verarbeitet / Rectificado



Pisos e Paredes  
Floor and Walls / Sol et Mur  
Wandfliesen und Bodenfliesen / Pisos y Paredes



Variação Média V1  
Average tone variation / Variation moyenne  
Durchschnittliche Tonhöhenchwankung  
Variación media de tono



Resistente ao gelo  
Frost resistant / Résistant au gel  
Frostbeständig / Resistente al hielo



Espessura  
Thickness / Épaisseur / Dicke / Grosor

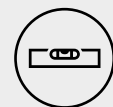

Recomendamos o uso de niveladores  
Recommended levelers / craisillons auto-nivellants conseillé  
Empfohlene Richtmaschinen / Niveladores recomendados



PCS  
1 Pcs  
3,12 m<sup>2</sup>  
45,50 Kg



PAL  
21 Pcs  
65,52 m<sup>2</sup>  
956 Kg

Caixa de embalagem de Lâminas  
até 21pcs/cx - C200/280, ref.: CXLAM.

## Monocolor Branco

2,60 m

POLISH

MATE

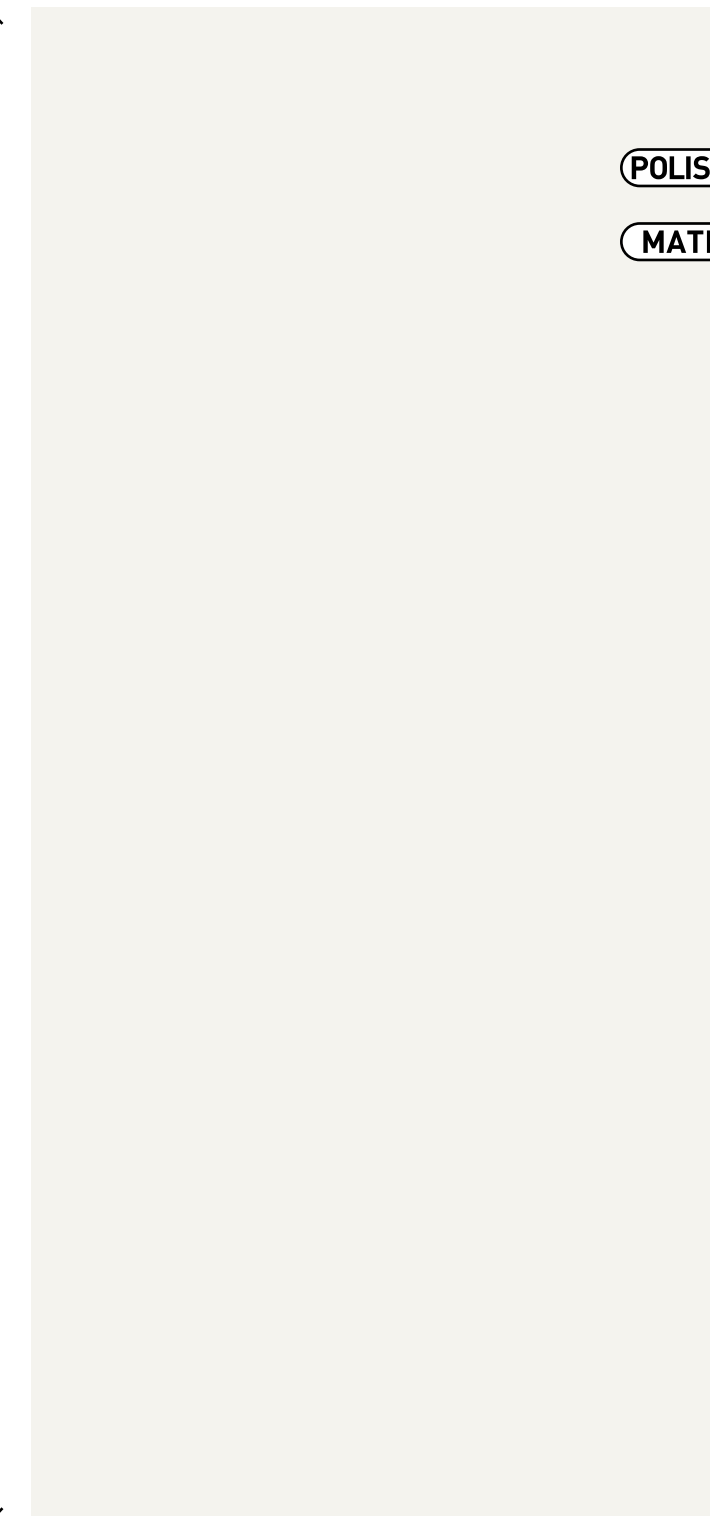

260x120 PORCELÂNICO

L80/112

Série: **Monocolor Branco - Polido**

Ref.: RLM120260MOBRP



5 606779 218995

260x120 PORCELÂNICO - 6mm

L75/105

Série: **Monocolor Branco - Mate**

Ref.: RLM120260MOBRMT



5 606779 219008





Porcelânico Esmaltado  
Glazed tiles, Grès cérame émaillé,  
Feinsteinzeug Glasiert, Porcelánico esmaltado



Retificado  
Rectified / Rectifié / Verarbeitet / Rectificado



Pisos e Paredes  
Floor and Walls / Sol et Mur  
Wandfliesen und Bodenfliesen / Pisos y Paredes



Variação Média V3  
Average tone variation / Variation moyenne  
Durchschnittliche Tonhöhenchwankung  
Variación media de tono



Resistente ao gelo  
Frost resistant / Résistant au gel  
Frostbeständig / Resistente al hielo



Espessura  
Thickness / Épaisseur / Dicke / Grosor



Recomendamos o uso de niveladores  
Recommended levelers / craisillons auto-nivellants conseillé  
Empfohlene Richtmaschinen / Niveladores recomendados



PCS

1 Pcs  
3,12 m<sup>2</sup>  
45,50 Kg



PAL

21 Pcs  
65,52 m<sup>2</sup>  
956 Kg

Caixa de embalagem de Láminas  
até 21pcs/cx - C200/280, ref.: CXLAM.

## Steel Lapato

2,60 m



260x120 PORCELÂNICO

L80/112

Série: **Steel Cooper - Lapato**

Ref.: RLM120260STCOLP



5 606779 214836





PE

Porcelânico Esmaltado  
Glazed tiles, Grès cérame émaillé,  
Feinsteinzeug Glasiert, Porcelánico esmaltado

RET

Retificado  
Rectified / Rectifié / Verarbeitet / Rectificado



Pisos e Paredes  
Floor and Walls / Sol et Mur  
Wandfliesen und Bodenfliesen / Pisos y Paredes



Variação Média V3  
Average tone variation / Variation moyenne  
Durchschnittliche Tonhöhenchwankung  
Variación media de tono



Resistente ao gelo  
Frost resistant / Résistant au gel  
Frostbeständig / Resistente al hielo



Espessura  
Thickness / Épaisseur / Dicke / Grosor

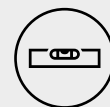

Recomendamos o uso de niveladores  
Recommended levelers / croisillons auto-nivellants conseillé  
Empfohlene Richtmaschinen / Niveladores recomendados

PCS

1 Pcs  
3,12 m<sup>2</sup>  
45,50 Kg

PAL

21 Pcs  
65,52 m<sup>2</sup>  
956 Kg

Caixa de embalagem de Láminas  
até 21pcs/cx - C200/280, ref.: CXLAM.

## Steel Artic Lapato

2,60 m

LAPATO

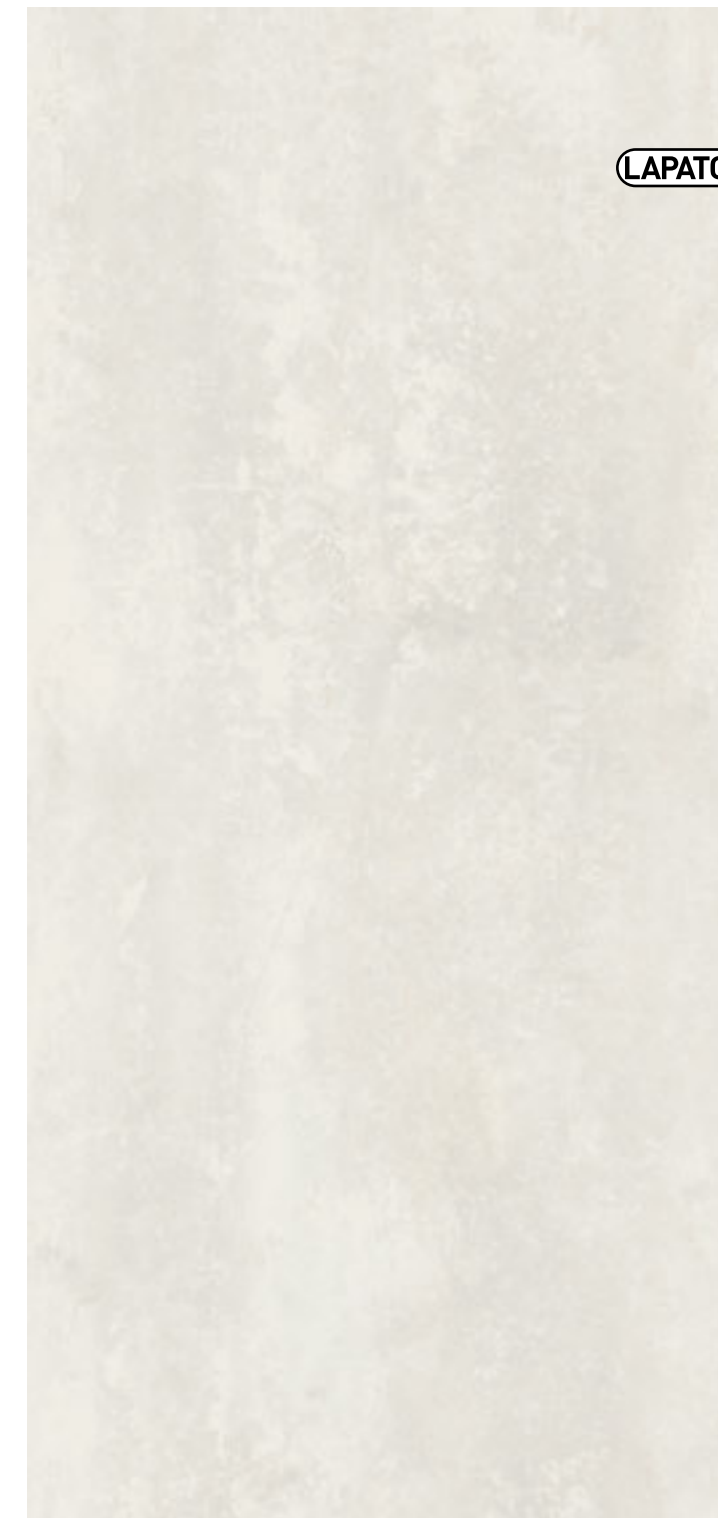

260x120 PORCELÂNICO

L80/112

Série: **Steel Artic - Lapato**Ref.: **RLM120260STARLP**

5 606779 214850



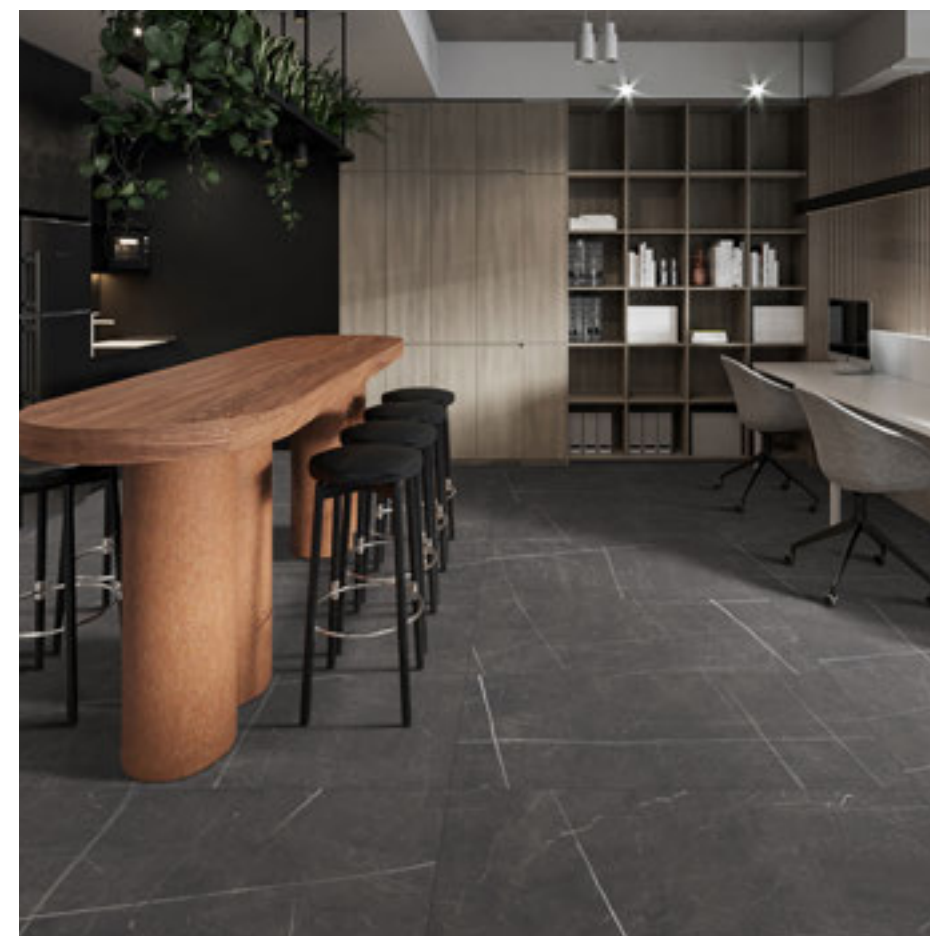

## PORCELÁNICOS

Porcelanic tiles / Gres Cerame

Porzellanfliesen / Porcelánicos

120x1,20

120x60

120x30

90x90

60x60





PE

Porcelânico Esmaltado  
Glazed tiles / Grès cérame émaillé,  
Feinsteinzeug Glasiert, Porcelánico esmaltado

RET

Retificado  
Rectified / Rectifié / Verarbeitet / Rectificado



Pisos e Paredes  
Floor and Walls / Sols et Murs  
Wandfliesen und Bodenfliesen / Pisos y Paredes



Variação Média V3  
Average tone variation / Variation moyenne  
Durchschnittliche Tonhöhenchwankung  
Variación media de tono



Resistente ao gelo  
Frost resistant / Résistant au gel  
Frostbeständig / Resistente al hielo



Espessura  
Thickness / Épaisseur / Dicke / Grosor



Recomendamos o uso de niveladores  
Recommended levelers / craisillons auto-nivellants conseillé  
Empfohlene Richtmaschinen / Niveladores recomendados

PCS

2 Pcs  
1,44 m<sup>2</sup>  
31 Kg

PAL

32 Cx  
46,08 m<sup>2</sup>  
1.010 Kg

Degraus rodapés e peças especiais  
na página 264 a 275.

# Signature Marfil

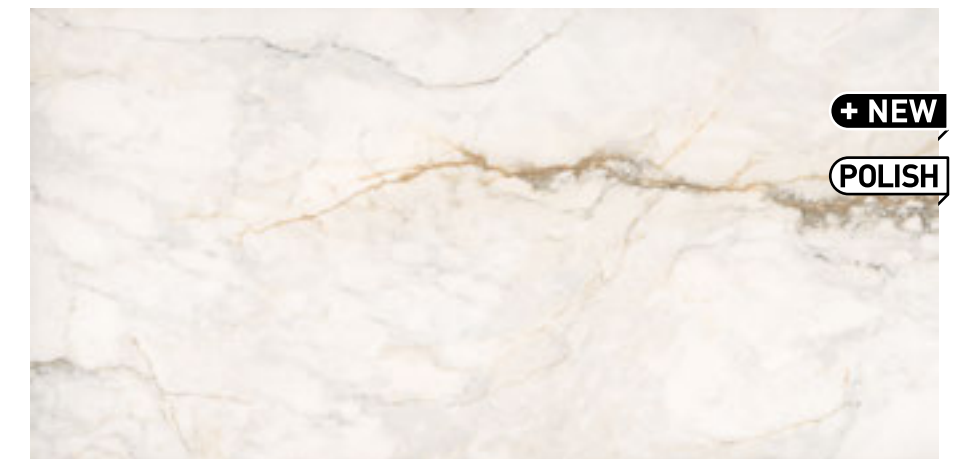

60x120 PORCELÂNICO

C30/42

Série: **Signature Marfil - Polido**

Ref.: RS60120MAPO



5 606779 250339



60x120 PORCELÂNICO

C28/40

Série: **Signature Marfil - Baby Satin**

Ref.: RS60120MABBS



5 606779 250346





Porcelânico Esmaltado  
Glazed tiles, Grès cérame émaillé,  
Feinsteinzeug Glasiert, Porcelánico esmaltado



Retificado  
Rectified / Rectifié / Verarbeitet / Rectificado



Pisos e Paredes  
Floor and Walls / Sols et Murs  
Wandfliesen und Bodenfliesen / Pisos y Paredes



Variação Média V3  
Average tone variation / Variation moyenne  
Durchschnittliche Tonhöhenchwankung  
Variación media de tono



Resistente ao gelo  
Frost resistant / Résistant au gel  
Frostbeständig / Resistente al hielo



Espessura  
Thickness / Épaisseur / Dicke / Grosor



Recomendamos o uso de niveladores  
Recommended levelers / craillons auto-nivellants conseillé  
Empfohlene Richtmaschinen / Niveladores recomendados



PCS  
2 Pcs  
1,44 m<sup>2</sup>  
31 Kg



PAL  
32 Cx  
46,08 m<sup>2</sup>  
1.010 Kg

Degraus rodapés e peças especiais  
na página 264 a 275.

## Signature Gold

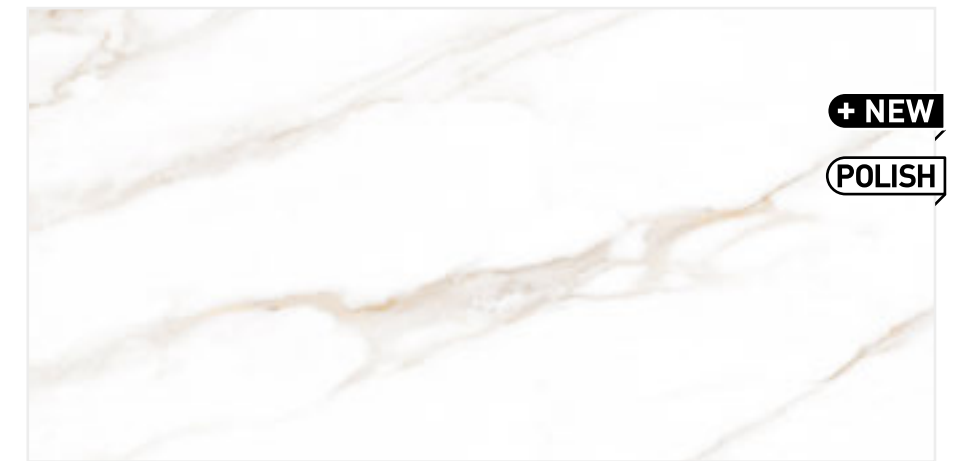

+ NEW

POLISH

60x120 PORCELÂNICO

C30/42

Série: **Signature Gold - Polido**

Ref.: RS60120GOPO



5 606779 250360

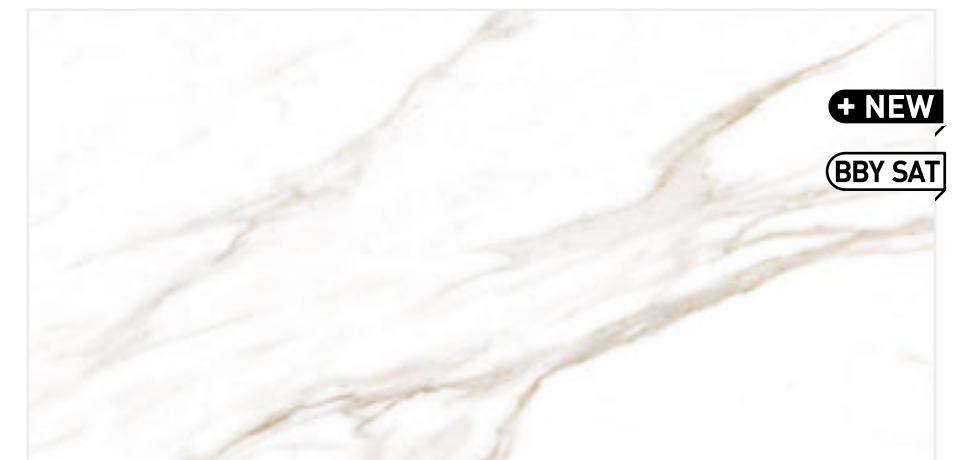

+ NEW

BBY SAT

60x120 PORCELÂNICO

C28/40

Série: **Signature Gold - Baby Satin**

Ref.: RS60120GOBBS



5 606779 250353





PE

Porcelânico Esmaltado  
Glazed tiles / Grès cérame émaillé,  
Feinsteinzeug Glasiert, Porcelánico esmaltado

RET

Retificado  
Rectified / Rectifié / Verarbeitet / Rectificado



Pisos e Paredes  
Floor and Walls / Sols et Murs  
Wandfliesen und Bodenfliesen / Pisos y Paredes



Varição Média V3  
Average tone variation / Variation moyenne  
Durchschnittliche Tonhöhenschwankung  
Variación media de tono



Resistente ao gelo  
Frost resistant / Résistant au gel  
Frostbeständig / Resistente al hielo



Espessura  
Thickness / Épaisseur / Dicke / Grosor



Recomendamos o uso de niveladores  
Recommended levelers / craisillons auto-nivellants conseillé  
Empfohlene Richtmaschinen / Niveladores recomendados

PCS

2 Pcs  
1,44 m<sup>2</sup>  
31 Kg

PAL

32 Cx  
46,08 m<sup>2</sup>  
1.010 Kg

Degraus rodapés e peças especiais  
na página 264 a 275.

## Signature Emil



60x120 PORCELÂNICO

C28/40

Série: Signature Emil - Baby Satin

Ref.: RS60120EMIBBS



5 606779 250377





Porcelânico Esmaltado  
Glazed tiles, Grès cérame émaillé,  
Feinsteinzeug Glasiert, Porcelânico esmaltado



Retificado  
Rectified / Rectifié / Verarbeitet / Rectificado



Pisos e Paredes  
Floor and Walls / Sols et Murs  
Wandfliesen und Bodenfliesen / Pisos y Paredes



Variação Média V3  
Average tone variation / Variation moyenne  
Durchschnittliche Tonhöhenchwankung  
Variación media de tono



Resistente ao gelo  
Frost resistant / Résistant au gel  
Frostbeständig / Resistente al hielo



Espessura  
Thickness / Épaisseur / Dicke / Grosor

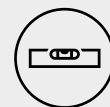

Recomendamos o uso de niveladores  
Recommended levelers / craisillons auto-nivellants conseillé  
Empfohlene Richtmaschinen / Niveladores recomendados



PCS  
2 Pcs  
1,44 m<sup>2</sup>  
31 Kg



PAL  
32 Cx  
46,08 m<sup>2</sup>  
1.010 Kg

Degraus rodapés e peças especiais  
na página 264 a 275.

# Calacata Supremo

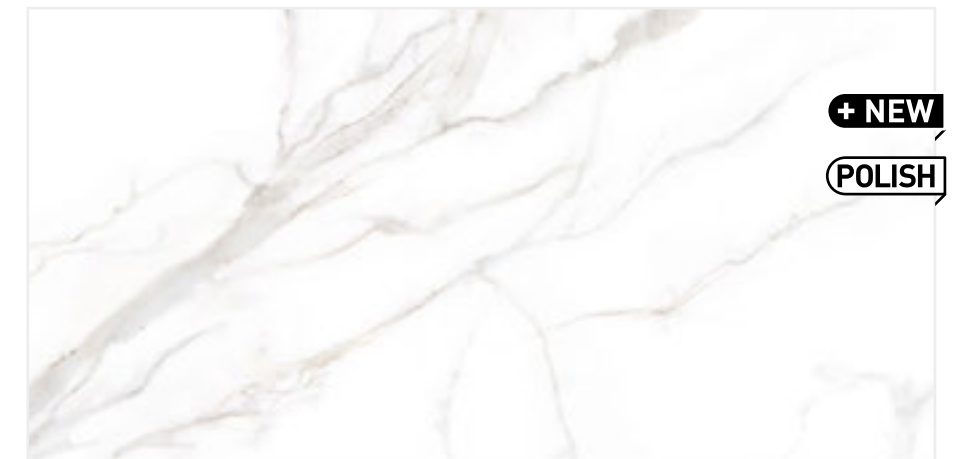

+ NEW

POLISH

60x120 PORCELÂNICO

C30/42

Série: **Calacata Supremo - Polido**

Ref.: RSC60120SRT



5 606779 252722



+ NEW

BBY SAT

60x120 PORCELÂNICO

C28/40

Série: **Calacata Supremo - Baby Satin**

Ref.: RSC60120SRTBB



5 606779 252890





PE

Porcelânico Esmaltado  
Glazed tiles, Grès cérame émaillé,  
Feinsteinzeug Glasiert, Porcelánico esmaltado

RET

Retificado  
Rectified / Rectifié / Verarbeitet / Rectificado



Pisos e Paredes  
Floor and Walls / Sols et Murs  
Wandfliesen und Bodenfliesen / Pisos y Paredes



Variação Média V3  
Average tone variation / Variation moyenne  
Durchschnittliche Tonhöhenchwankung  
Variación media de tono



Resistente ao gelo  
Frost resistant / Résistant au gel  
Frostbeständig / Resistente al hielo



Espessura  
Thickness / Épaisseur / Dicke / Grosor



Recomendamos o uso de niveladores  
Recommended levelers / craillons auto-nivellants conseillé  
Empfohlene Richtmaschinen / Niveladores recomendados



PCS

2 Pcs  
1,44 m<sup>2</sup>  
31 Kg



PAL

32 Cx  
46,08 m<sup>2</sup>  
1.010 Kg

Degraus rodapés e peças especiais  
na página 264 a 275.

# Scavato Basalt



+ NEW

CARV

60x120 PORCELÂNICO

C32/45

Série: Scavato Basalt - Mate Carving

Ref.: RSC60120BASCA



5 606779 250414

\* ACABAMENTO CARV: SUPERFÍCIE MATE E VEIOS ESCAVADOS COM BRILHO





Porcelânico Esmaltado  
Glazed tiles, Grès cérame émaillé,  
Feinsteinzeug Glasiert, Porcelánico esmaltado



Retificado  
Rectified / Rectifié / Verarbeitet / Rectificado



Pisos e Paredes  
Floor and Walls / Sols et Murs  
Wandfliesen und Bodenfliesen / Pisos y Paredes



Variação Média V3  
Average tone variation / Variation moyenne  
Durchschnittliche Tonhöhenchwankung  
Variación media de tono



Resistente ao gelo  
Frost resistant / Résistant au gel  
Frostbeständig / Resistente al hielo



Espessura  
Thickness / Épaisseur / Dicke / Grosor

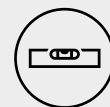

Recomendamos o uso de niveladores  
Recommended levelers / craisillons auto-nivellants conseillé  
Empfohlene Richtmaschinen / Niveladores recomendados



PCS  
2 Pcs  
1,44 m<sup>2</sup>  
31 Kg



PAL  
32 Cx  
46,08 m<sup>2</sup>  
1.010 Kg

Degraus rodapés e peças especiais  
na página 264 a 275.

## Scavato Negro



60x120 PORCELÂNICO

C32/45

Série: **Scavato Negro - Mate Carving**

Ref.: RSC60120NECA



5 606779 250407

\* ACABAMENTO CARV: SUPERFÍCIE MATE E VEIOS ESCAVADOS COM BRILHO





Porcelânico Esmaltado  
Glazed tiles, Grès cérame émaillé,  
Feinsteinzeug Glasiert, Porcelánico esmaltado



Retificado  
Rectified / Rectifié / Verarbeitet / Rectificado



Pisos e Paredes  
Floor and Walls / Sols et Murs  
Wandfliesen und Bodenfliesen / Pisos y Paredes



Variação Média V3  
Average tone variation / Variation moyenne  
Durchschnittliche Tonhöhenchwankung  
Variación media de tono



Resistente ao gelo  
Frost resistant / Résistant au gel  
Frostbeständig / Resistente al hielo



Espessura  
Thickness / Épaisseur / Dicke / Grosor



Recomendamos o uso de niveladores  
Recommended levelers / craillons auto-nivellants conseillé  
Empfohlene Richtmaschinen / Niveladores recomendados



PCS  
2 Pcs  
1,44 m<sup>2</sup>  
31 Kg



PAL  
32 Cx  
46,08 m<sup>2</sup>  
1.010 Kg

Degraus rodapés e peças especiais  
na página 264 a 275.

## Scavato Oro

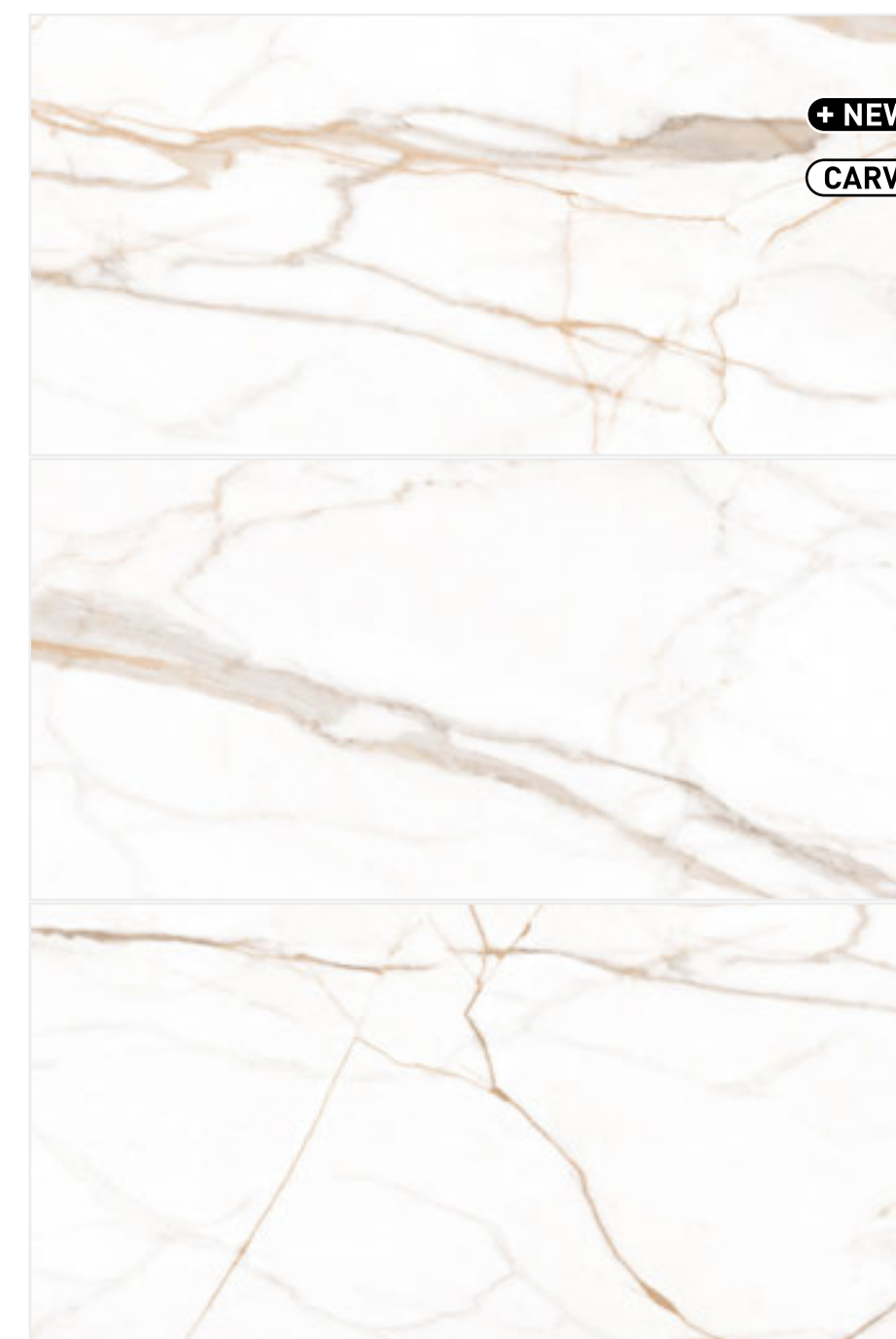

60x120 PORCELÂNICO

C32/45

Série: Scavato Oro - Mate Carving

Ref: RSC60120ORCA



5 606779 250384

\* ACABAMENTO CARV: SUPERFÍCIE MATE E VEIOS ESCAVADOS COM BRILHO



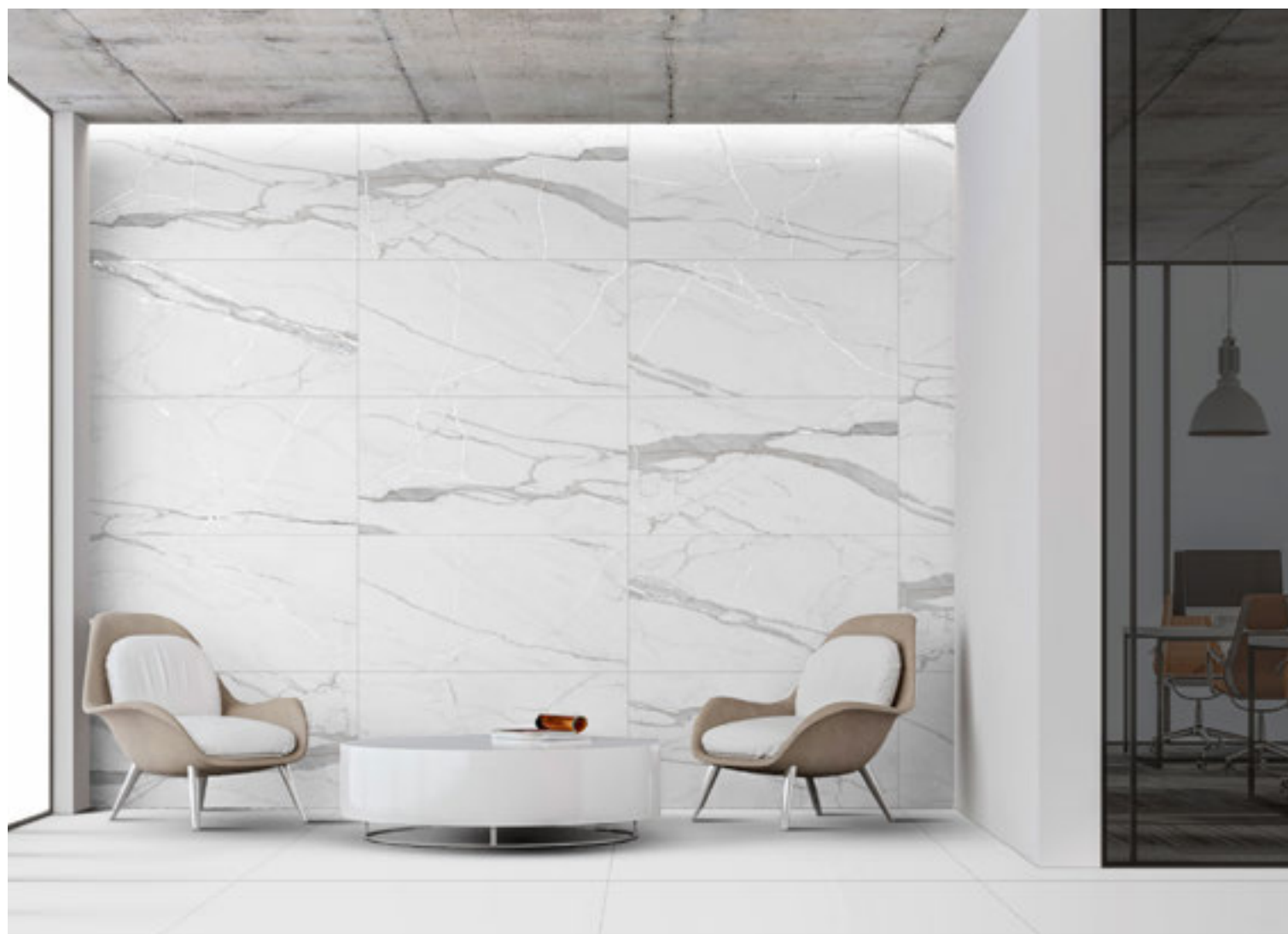

Porcelânico Esmaltado  
Glazed tiles, Grès cérame émaillé,  
Feinsteinzeug Glasiert, Porcelânico esmaltado



Retificado  
Rectified / Rectifié / Verarbeitet / Rectificado



Pisos e Paredes  
Floor and Walls / Sols et Murs  
Wandfliesen und Bodenfliesen / Pisos y Paredes



Variação Média V3  
Average tone variation / Variation moyenne  
Durchschnittliche Tonhöhenchwankung  
Variación media de tono



Resistente ao gelo  
Frost resistant / Résistant au gel  
Frostbeständig / Resistente al hielo



Espessura  
Thickness / Épaisseur / Dicke / Grosor



Recomendamos o uso de niveladores  
Recommended levelers / craillons auto-nivellants conseillé  
Empfohlene Richtmaschinen / Niveladores recomendados



PCS  
2 Pcs  
1,44 m<sup>2</sup>  
31 Kg



PAL  
32 Cx  
46,08 m<sup>2</sup>  
1.010 Kg

Degraus rodapés e peças especiais  
na página 264 a 275.

## Scavato Silver



60x120 PORCELÂNICO

C32/45

Série: Scavato Silver - Mate Carving

Ref.: RSC60120SILCA



5 606779 250391

\* ACABAMENTO CARV: SUPERFÍCIE MATE E VEIOS ESCAVADOS COM BRILHO





Porcelânico Esmaltado  
Glazed tiles, Grès cérame émaillé,  
Feinsteinzeug Glasiert, Porcelánico esmaltado



Retificado  
Rectified / Rectifié / Verarbeitet / Rectificado



Pisos e Paredes  
Floor and Walls / Sols et Murs  
Wandfliesen und Bodenfliesen / Pisos y Paredes



Variação Média V3  
Average tone variation / Variation moyenne  
Durchschnittliche Tonhöhenchwankung  
Variación media de tono



Resistente ao gelo  
Frost resistant / Résistant au gel  
Frostbeständig / Resistente al hielo



Espessura  
Thickness / Épaisseur / Dicke / Grosor



Recomendamos o uso de niveladores  
Recommended levels / craisillons auto-nivellants conseillé  
Empfohlene Richtmaschinen / Niveladores recomendados



PCS  
2 Pcs  
1,44 m<sup>2</sup>  
31 Kg



PAL  
32 Cx  
46,08 m<sup>2</sup>  
1.010 Kg

Degraus rodapés e peças especiais  
na página 264 a 275.

# Afyon

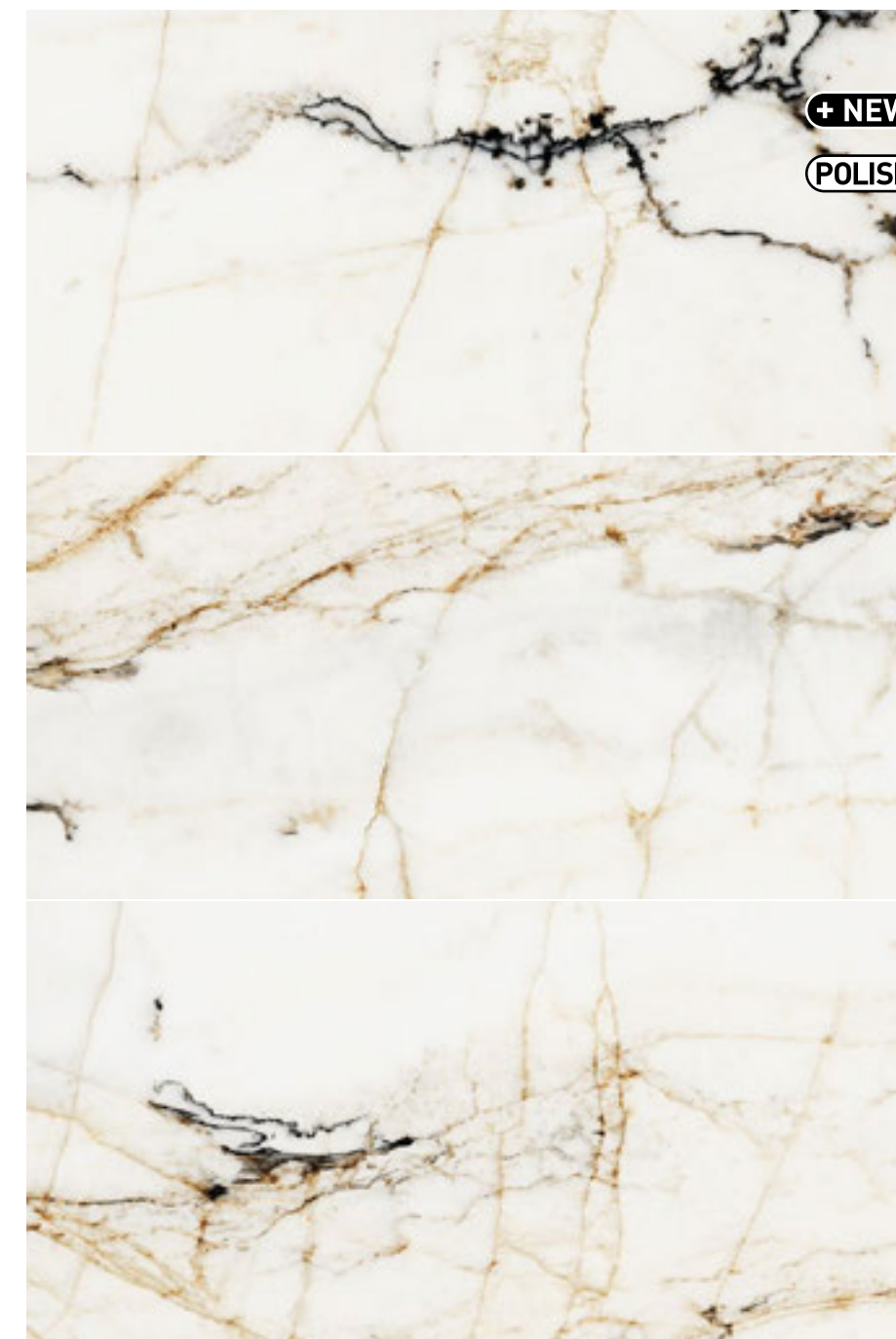

60x120 PORCELÂNICO

C30/42

Série: Afyon - Polido

Ref.: RC60120AFYP



5 606779 250919





Porcelânico Esmaltado  
Glazed tiles / Grès cérame émaillé,  
Feinsteinzeug Glasiert, Porcelánico esmaltado



Retificado  
Rectified / Rectifié / Verarbeitet / Rectificado



Pisos e Paredes  
Floor and Walls / Sols et Murs  
Wandfliesen und Bodenfliesen / Pisos y Paredes



Variação Média V3  
Average tone variation / Variation moyenne  
Durchschnittliche Tonhöenschwankung  
Variación media de tono



Resistente ao gelo  
Frost resistant / Résistant au gel  
Frostbeständig / Resistente al hielo



Espessura  
Thickness / Épaisseur / Dicke / Grosor



Recomendamos o uso de niveladores  
Recommended levelers / craisillons auto-nivellants conseillé  
Empfohlene Richtmaschinen / Niveladores recomendados



PCS  
2 Pcs  
1,44 m<sup>2</sup>  
31 Kg



PAL  
32 Cx  
46,08 m<sup>2</sup>  
1.010 Kg

Degraus rodapés e peças especiais  
na página 264 a 275.

# Rockford Grey

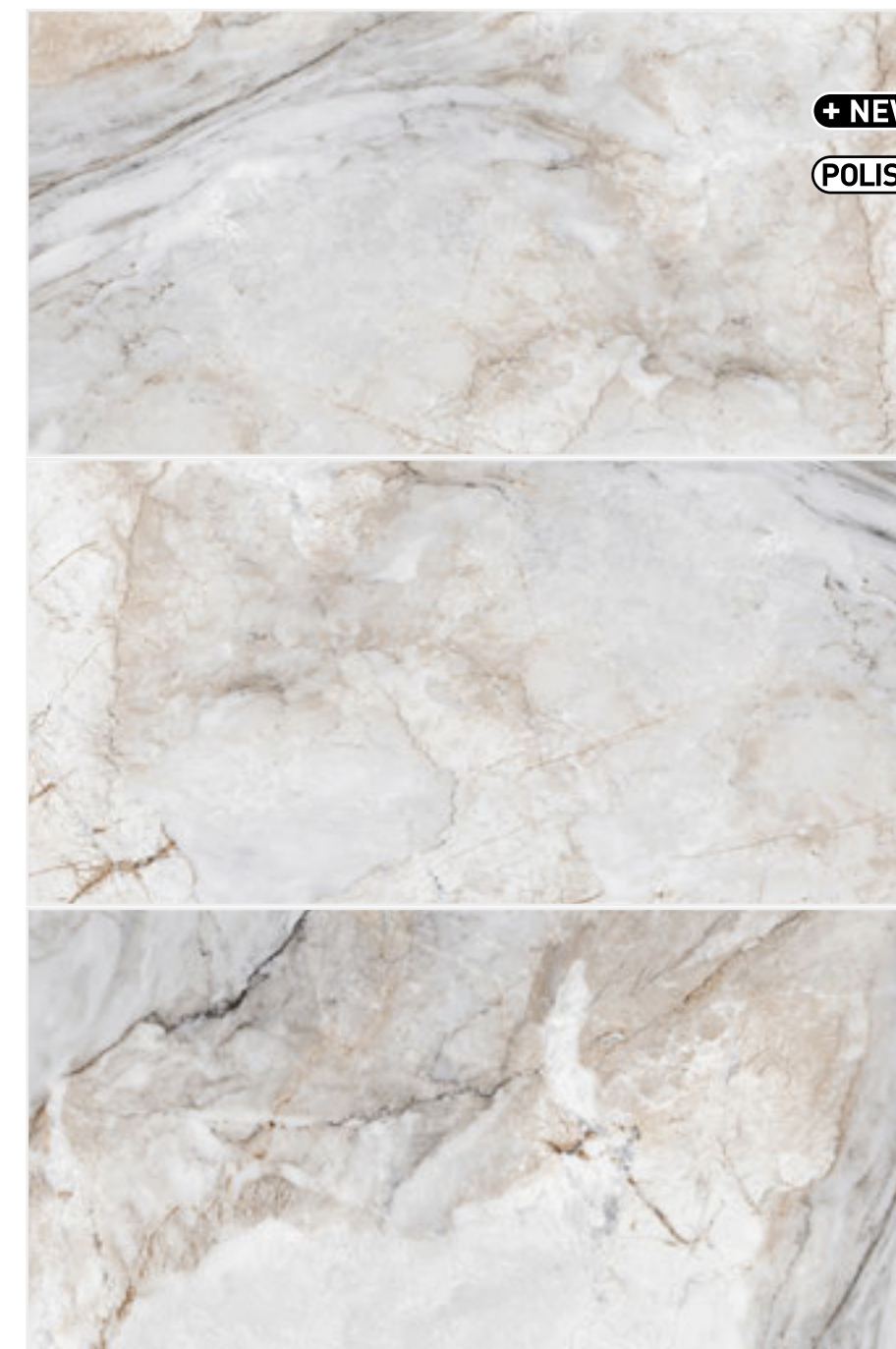

+ NEW

POLISH

60x120 PORCELÂNICO

C30/42

Série: **Rockford Grey - Polido**

Ref.: RJE60I20ROFP



5 606779 229632





Porcelânico Esmaltado  
Glazed tiles, Grès cérame émaillé,  
Feinsteinzeug Glasiert, Porcelánico esmaltado



Retificado  
Rectified / Rectifié / Verarbeitet / Rectificado



Pisos e Paredes  
Floor and Walls / Sols et Murs  
Wandfliesen und Bodenfliesen / Pisos y Paredes



Varição Média V3  
Average tone variation / Variation moyenne  
Durchschnittliche Tonhöhen schwankung  
Variación media de tono



Resistente ao gelo  
Frost resistant / Résistant au gel  
Frostbeständig / Resistente al hielo



Espessura  
Thickness / Épaisseur / Dicke / Grosor



Recomendamos o uso de niveladores  
Recommended levelers / craisillons auto-nivellants conseillé  
Empfohlene Richtmaschinen / Niveladores recomendados



**60x120**  
2 Pcs  
1,44 m<sup>2</sup>  
30,6 Kg



**60x60**  
4 Pcs  
1,44 m<sup>2</sup>  
28,5 Kg



**PAL**  
32 Cx  
46,08 m<sup>2</sup>  
1.010 Kg



**PAL**  
40 Cx  
57,60 m<sup>2</sup>  
1.155 Kg

Degraus rodapés e peças especiais  
na página 264 a 275.

## Statuario Norwell



60x60 PORCELÂNICO

**C30/42**

Série: **Statuario Norwell - Polido**

Ref.: RC6060STNP



5 606779 253194



60x60 PORCELÂNICO

**C22/31**

Série: **Statuario Norwell - Polido**

Ref.: RC6060STNP



5 606779 253194





PE

Porcelânico Esmaltado  
Glazed tiles / Grès cérame émaillé,  
Feinsteinzeug Glasier, Porcelánico esmaltado

RET

Retificado  
Rectified / Rectifié / Verarbeitet / Rectificado



Pisos e Paredes  
Floor and Walls / Sols et Murs  
Wandfliesen und Bodenfliesen / Pisos y Paredes



Variação Média V3  
Average tone variation / Variation moyenne  
Durchschnittliche Tonhöhenchwankung  
Variación media de tono



Resistente ao gelo  
Frost resistant / Résistant au gel  
Frostbeständig / Resistente al hielo



Espessura  
Thickness / Épaisseur / Dicke / Grosor



Recomendamos o uso de niveladores  
Recommended levelers / craisillons auto-nivellants conseillé  
Empfohlene Richtmaschinen / Niveladores recomendados



PCS  
2 Pcs  
1,44 m<sup>2</sup>  
31 Kg



PAL  
32 Cx  
46,08 m<sup>2</sup>  
1.010 Kg

Degraus rodapés e peças especiais  
na página 264 a 275.

## Calcutta Cooper



60x120 PORCELÂNICO

C30/42

Série: **Calcutta Cooper - Polido**

Ref.: RC60120CTCP



5 606779 250940



## Calcutta Drama

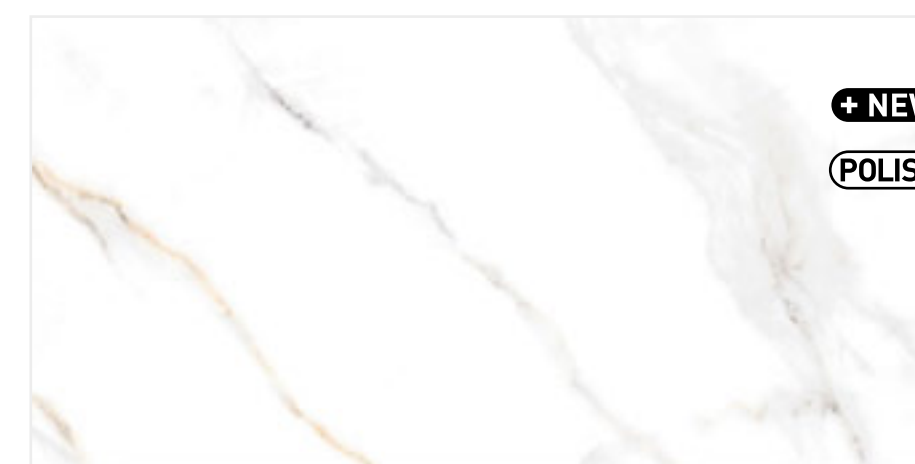

60x120 PORCELÂNICO

C30/42

Série: **Calcutta Drama - Polido**

Ref.: RC60120CTDP



5 606779 250933





Porcelânico Esmaltado  
Glazed tiles / Grès cérame émaillé,  
Feinsteinzeug Glasiert, Porcelánico esmaltado



Retificado  
Rectified / Rectifié / Verarbeitet / Rectificado



Pisos e Paredes  
Floor and Walls / Sols et Murs  
Wandfliesen und Bodenfliesen / Pisos y Paredes



Variação Média V3  
Average tone variation / Variation moyenne  
Durchschnittliche Tonhöhen schwankung  
Variación media de tono



Resistente ao gelo  
Frost resistant / Résistant au gel  
Frostbeständig / Resistente al hielo



Espessura  
Thickness / Épaisseur / Dicke / Grosor



Recomendamos o uso de niveladores  
Recommended levelers / craillons auto-nivellants conseillé  
Empfohlene Richtmaschinen / Niveladores recomendados



PCS  
2 Pcs  
1,44 m<sup>2</sup>  
31 Kg



PAL  
32 Cx  
46,08 m<sup>2</sup>  
1.010 Kg

Degraus rodapés e peças especiais  
na página 264 a 275.

## Emporium Bege



+ NEW

POLISH

60x120 PORCELÂNICO

C30/42

Série: **Emporium Bege - Polido**

Ref.: REM60120BEP



5 606779 229151

## Emporium Gold

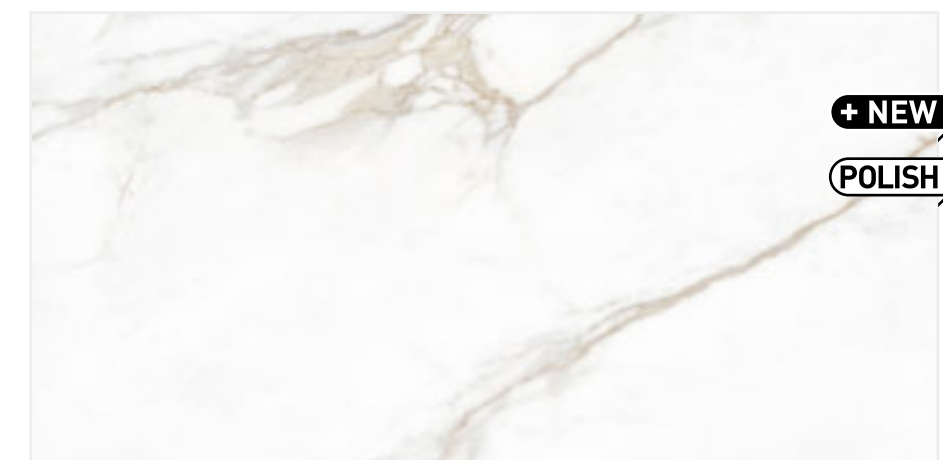

+ NEW

POLISH

60x120 PORCELÂNICO

C30/42

Série: **Emporium Gold - Polido**

Ref.: REM60120GOP



5 606779 229175





Porcelânico Esmaltado  
Glazed tiles, Grès cérame émaillé,  
Feinsteinzeug Glasiert, Porcelânico esmaltado



Retificado  
Rectified / Rectifié / Verarbeitet / Rectificado



Pisos e Paredes  
Floor and Walls / Sols et Murs  
Wandfliesen und Bodenfliesen / Pisos y Paredes



Variação Média V3  
Average tone variation / Variation moyenne  
Durchschnittliche Tonhöhenchwankung  
Variación media de tono



Resistente ao gelo  
Frost resistant / Résistant au gel  
Frostbeständig / Resistente al hielo



Espessura  
Thickness / Épaisseur / Dicke / Grosor



Recomendamos o uso de niveladores  
Recommended levelers / cratillons auto-nivellants conseillé  
Empfohlene Richtmaschinen / Niveladores recomendados



PCS  
2 Pcs  
1,44 m<sup>2</sup>  
31 Kg



PAL  
32 Cx  
46,08 m<sup>2</sup>  
1.010 Kg

Degraus rodapés e peças especiais  
na página 264 a 275.

# Jerin White



+ NEW

POLISH

60x120 PORCELÂNICO

C30/42

Série: Jerin White - Polido

Ref: RJE60I20JEW P



5 606779 229625





Porcelânico Esmaltado  
Glazed tiles, Grès cérame émaillé,  
Feinsteinzeug Glasiert, Porcelánico esmaltado



Retificado  
Rectified / Rectifié / Verarbeitet / Rectificado



Pisos e Paredes  
Floor and Walls / Sols et Murs  
Wandfliesen und Bodenfliesen / Pisos y Paredes



Variação Média V3  
Average tone variation / Variation moyenne  
Durchschnittliche Tonhöhenchwankung  
Variación media de tono



Resistente ao gelo  
Frost resistant / Résistant au gel  
Frostbeständig / Resistente al hielo



Espessura  
Thickness / Épaisseur / Dicke / Grosor

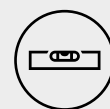

Recomendamos o uso de niveladores  
Recommended levelers / craisillons auto-nivellants conseillé  
Empfohlene Richtmaschinen / Niveladores recomendados



PCS  
2 Pcs  
1,44 m<sup>2</sup>  
31 Kg



PAL  
32 Cx  
46,08 m<sup>2</sup>  
1.010 Kg

Degraus rodapés e peças especiais  
na página 264 a 275.

# Endless Mystery White

4 PEÇAS COM VEIOS CONTÍNUOS



+ NEW

POLISH

60x120 PORCELÂNICO

C30/42

Série: **Endless Mistery White - Polido**

Ref.: REN60120MYWP







Porcelânico Esmaltado  
Glazed tiles, Grès cérame émaillé,  
Feinsteinzeug Glasiert, Porcelánico esmaltado



Retificado  
Rectified / Rectifié / Verarbeitet / Rectificado



Pisos e Paredes  
Floor and Walls / Sols et Murs  
Wandfliesen und Bodenfliesen / Pisos y Paredes



Variação Média V3  
Average tone variation / Variation moyenne  
Durchschnittliche Tonhöhen-schwankung  
Variación media de tono



Resistente ao gelo  
Frost resistant / Résistant au gel  
Frostbeständig / Resistente al hielo



Espessura  
Thickness / Épaisseur / Dicke / Grosor



Recomendamos o uso de niveladores  
Recommended levelers / craisillons auto-nivellants conseillé  
Empfohlene Richtmaschinen / Niveladores recomendados



PCS  
2 Pcs  
1,44 m<sup>2</sup>  
31 Kg



PAL  
32 Cx  
46,08 m<sup>2</sup>  
1.010 Kg

Degraus rodapés e peças especiais  
na página 264 a 275.

# Endless Nordic Grey

4 PEÇAS COM VEIOS CONTÍNUOS

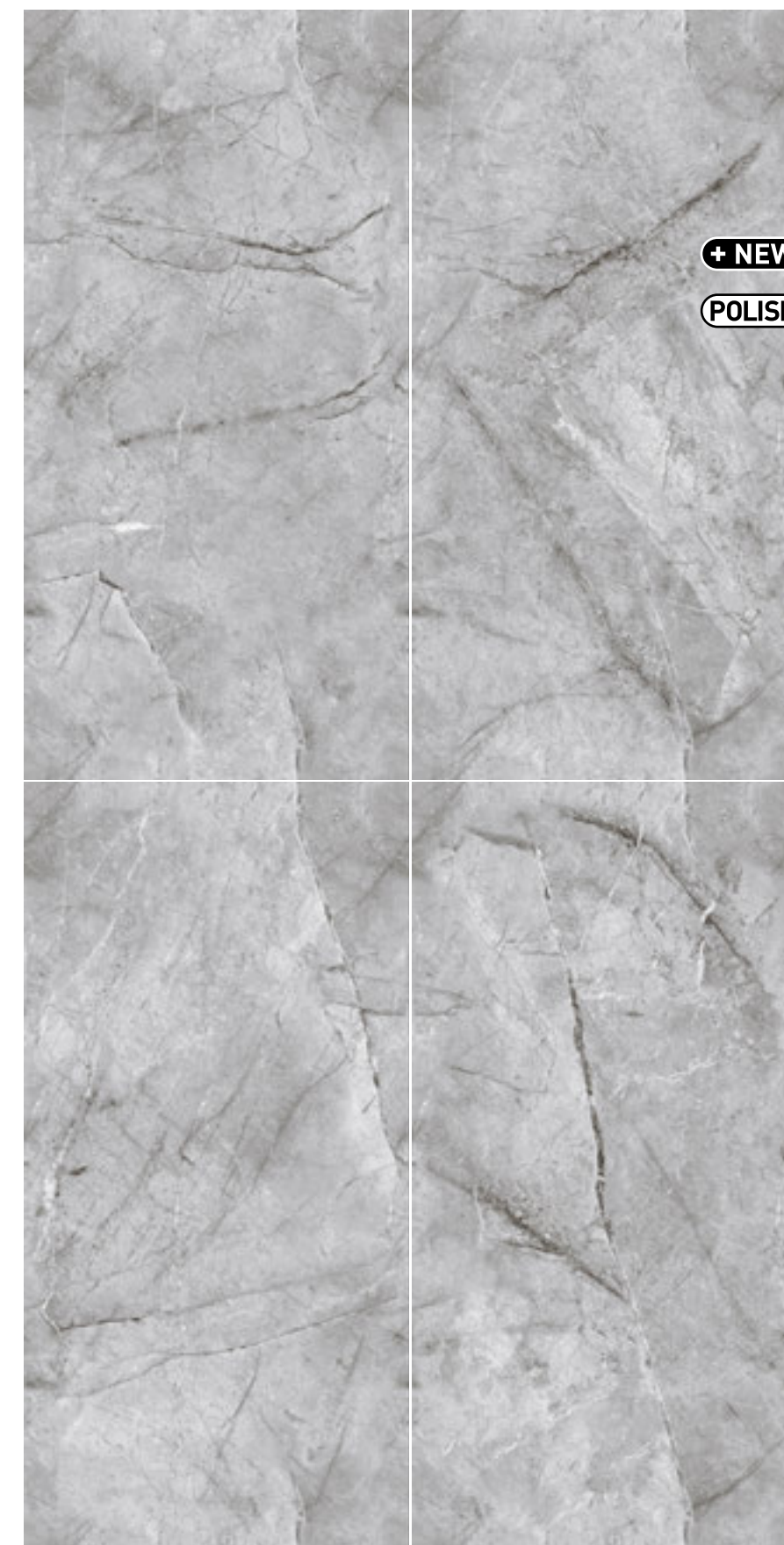

+ NEW

POLISH

60x120 PORCELÂNICO

C30/42

Série: **Endless Nordic Grey - Polido**

Ref.: REN60120NGRP



5 606779 229618





Porcelânico Esmaltado  
Glazed tiles, Grès cérame émaillé,  
Feinsteinzeug Glasiert, Porcelánico esmaltado



Retificado  
Rectified / Rectifié / Verarbeitet / Rectificado



Pisos e Paredes  
Floor and Walls / Sols et Murs  
Wandfliesen und Bodenfliesen / Pisos y Paredes



Variação Média V3  
Average tone variation / Variation moyenne  
Durchschnittliche Tonhöhenchwankung  
Variación media de tono



Resistente ao gelo  
Frost resistant / Résistant au gel  
Frostbeständig / Resistente al hielo



Espessura  
Thickness / Épaisseur / Dicke / Grosor

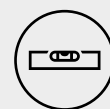

Recomendamos o uso de niveladores  
Recommended levelers / craisillons auto-nivellants conseillé  
Empfohlene Richtmaschinen / Niveladores recomendados



PCS  
2 Pcs  
1,44 m<sup>2</sup>  
31 Kg



PAL  
32 Cx  
46,08 m<sup>2</sup>  
1.010 Kg

Degraus rodapés e peças especiais  
na página 264 a 275.

# Endless Nordic Nude

4 PEÇAS COM VEIOS CONTÍNUOS

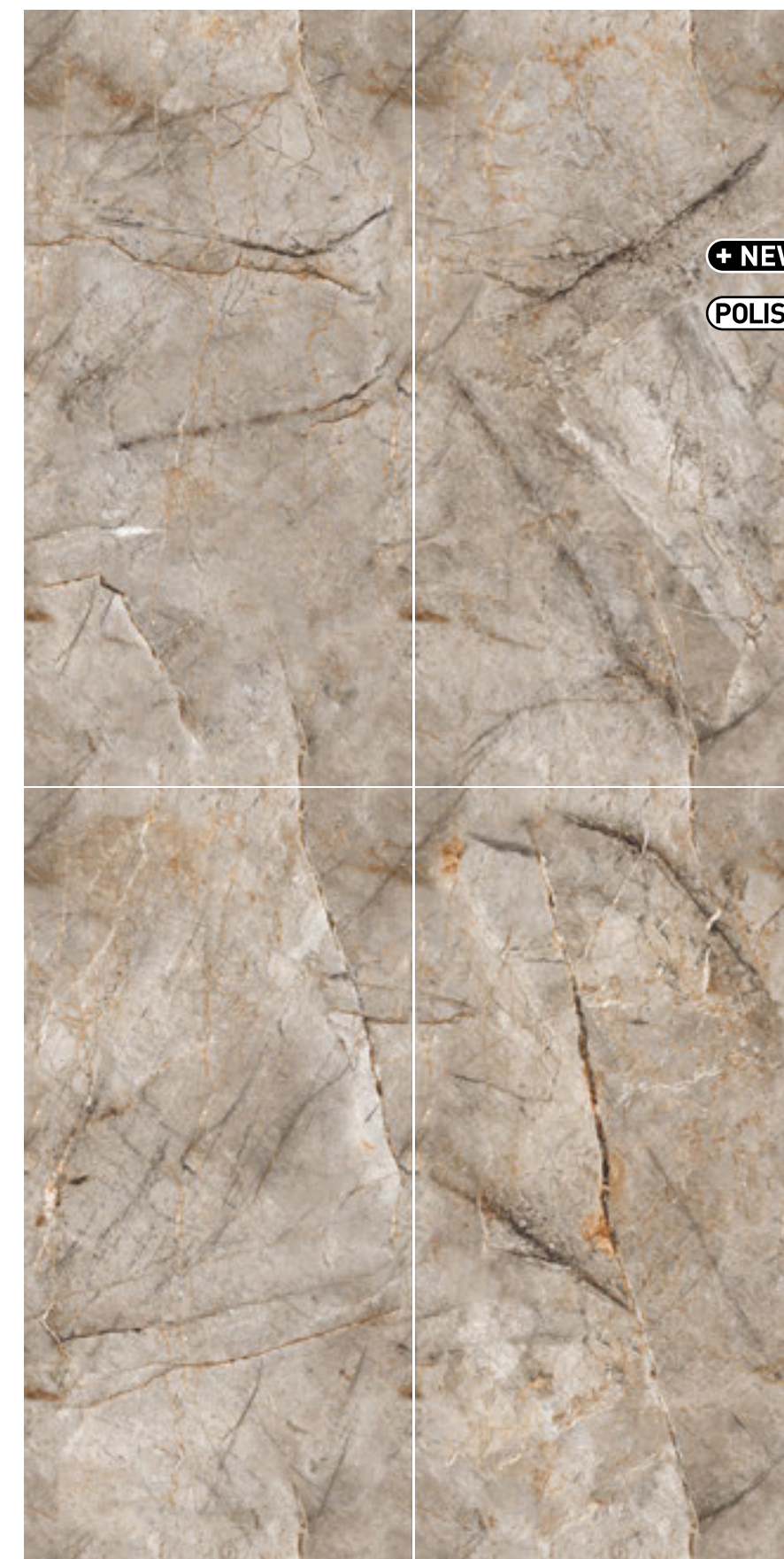

60x120 PORCELÂNICO

C30/42

Série: **Endless Nordic Nude - Polido**

Ref.: REN60120NNUP



5 606779 229601





Porcelânico Esmaltado  
Glazed tiles, Grès cérame émaillé,  
Feinsteinzeug Glasiert, Porcelánico esmaltado



Retificado  
Rectified / Rectifié / Verarbeitet / Rectificado



Pisos e Paredes  
Floor and Walls / Sols et Murs  
Wandfliesen und Bodenfliesen / Pisos y Paredes



Variação Média V3  
Average tone variation / Variation moyenne  
Durchschnittliche Tonhöhen schwankung  
Variación media de tono



Resistente ao gelo  
Frost resistant / Résistant au gel  
Frostbeständig / Resistente al hielo



Espessura  
Thickness / Épaisseur / Dicke / Grosor



Recomendamos o uso de niveladores  
Recommended levelers / craisillons auto-nivellants conseillé  
Empfohlene Richtmaschinen / Niveladores recomendados



PCS  
2 Pcs  
1,44 m<sup>2</sup>  
31 Kg



PAL  
32 Cx  
46,08 m<sup>2</sup>  
1.010 Kg

Degraus rodapés e peças especiais  
na página 264 a 275.

# Goldmine

PORCELÂNICOS

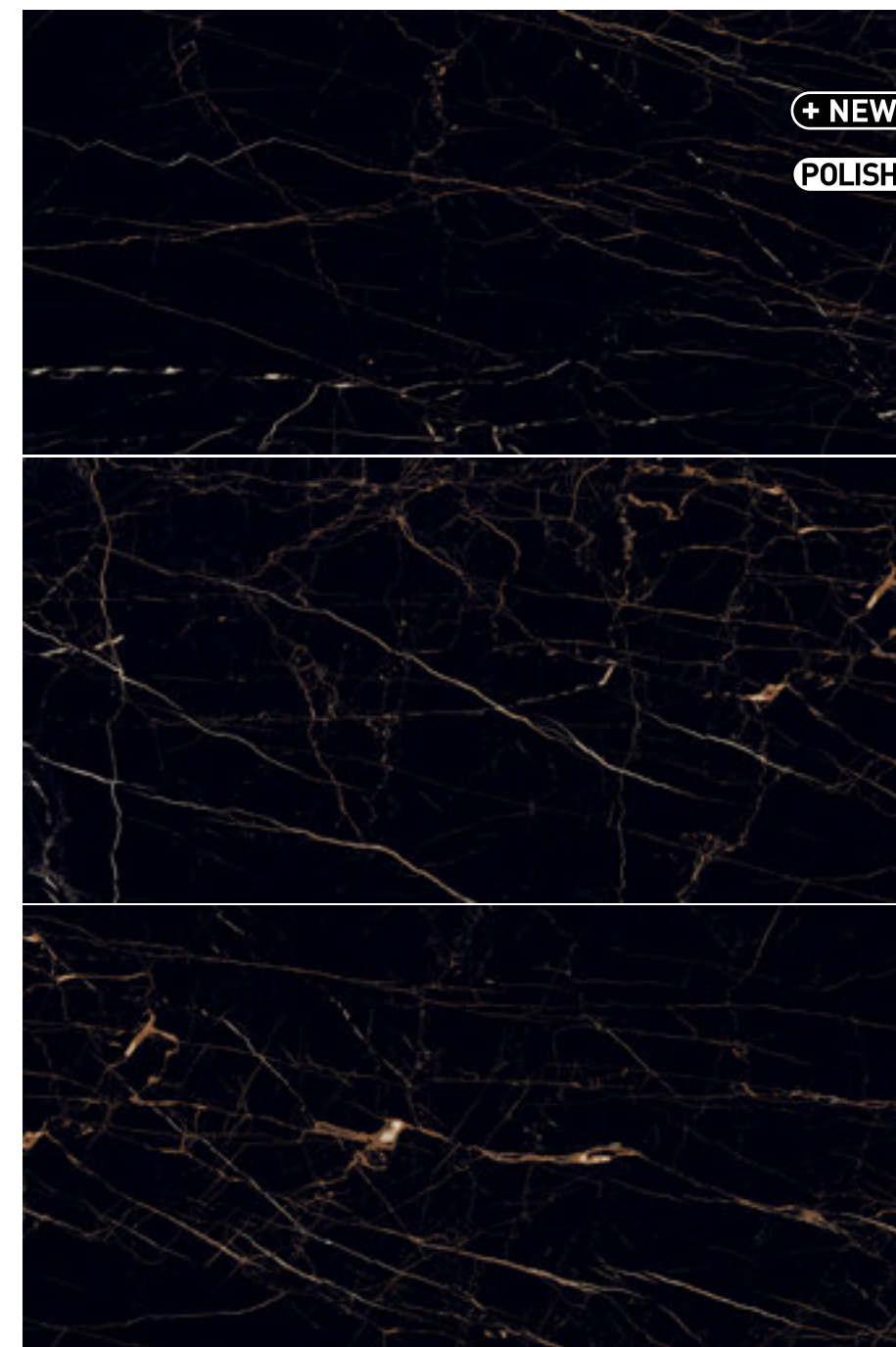

+ NEW

POLISH

60x120 PORCELÂNICO

C32/45

Série: Goldmine - Polido

Ref.: RGM60120P



5 606779 252876





PE

Porcelânico Esmaltado  
Glazed tiles, Grès cérame émaillé,  
Feinsteinzeug Glasiert, Porcelánico esmaltado

RET

Retificado  
Rectified / Rectifié / Verarbeitet / Rectificado



Pisos e Paredes  
Floor and Walls / Sols et Murs  
Wandfliesen und Bodenfliesen / Pisos y Paredes



Variação Média V3  
Average tone variation / Variation moyenne  
Durchschnittliche Tonhöhenchwankung  
Variación media de tono



Resistente ao gelo  
Frost resistant / Résistant au gel  
Frostbeständig / Resistente al hielo



Espessura  
Thickness / Épaisseur / Dicke / Grosor



Recomendamos o uso de niveladores  
Recommended levelers / craisillons auto-nivellants conseillé  
Empfohlene Richtmaschinen / Niveladores recomendados



PCS

2 Pcs  
1,44 m<sup>2</sup>  
31 Kg



PAL

32 Cx  
46,08 m<sup>2</sup>  
1.010 Kg

Degraus rodapés e peças especiais  
na página 264 a 275.

# Harvest Nero

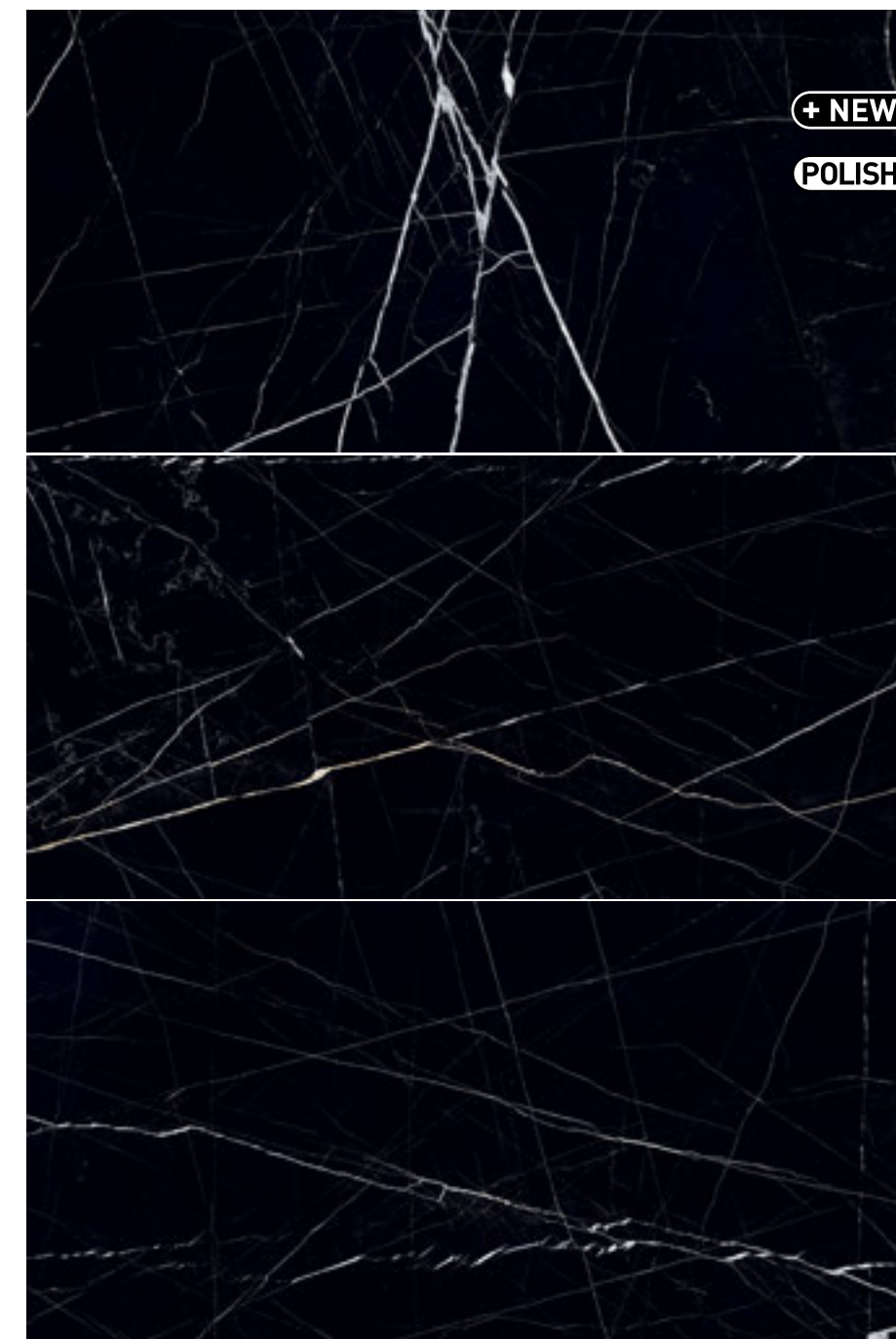

60x120 PORCELÂNICO

C32/45

Série: **Harvest Nero - Polido**

Ref: RH60120NP



5 606779 252869





PE

Porcelânico Esmaltado  
Glazed tiles, Grès cérame émaillé,  
Feinsteinzeug Glasiert, Porcelánico esmaltado

RET

Retificado  
Rectified / Rectifié / Verarbeitet / Rectificado



Pisos e Paredes  
Floor and Walls / Sols et Murs  
Wandfliesen und Bodenfliesen / Pisos y Paredes



Variação Média V3  
Average tone variation / Variation moyenne  
Durchschnittliche Tonhöhenchwankung  
Variación media de tono



Resistente ao gelo  
Frost resistant / Résistant au gel  
Frostbeständig / Resistente al hielo



Espessura  
Thickness / Épaisseur / Dicke / Grosor



Recomendamos o uso de niveladores  
Recommended levelers / craisillons auto-nivellants conseillé  
Empfohlene Richtmaschinen / Niveladores recomendados



PCS

2 Pcs  
1,44 m<sup>2</sup>  
31 Kg



PAL

32 Cx  
46,80 m<sup>2</sup>  
1.010 Kg

Degraus rodapés e peças especiais  
na página 264 a 275.

# Armani Nero Venatto



60x120 PORCELÂNICO

C32/45

Série: **Armani Nero Venatto - Polido**

Ref.: RA60120NVP



5 606779 193469





Porcelânico Esmaltado  
Glazed tiles, Grès cérame émaillé,  
Feinsteinzeug Glasiert, Porcelánico esmaltado



Retificado  
Rectified / Rectifié / Verarbeitet / Rectificado



Pisos e Paredes  
Floor and Walls / Sols et Murs  
Wandfliesen und Bodenfliesen / Pisos y Paredes



Variação Média V3  
Average tone variation / Variation moyenne  
Durchschnittliche Tonhöhenchwankung  
Variación media de tono



Resistente ao gelo  
Frost resistant / Résistant au gel  
Frostbeständig / Resistente al hielo



Espessura  
Thickness / Épaisseur / Dicke / Grosor

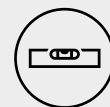

Recomendamos o uso de niveladores  
Recommended levelers / croisillons auto-nivellants conseillé  
Empfohlene Richtmaschinen / Niveladores recomendados

**60x120**

2 Pcs  
1,44 m<sup>2</sup>  
31 Kg

**60x60**

4 Pcs  
1,44 m<sup>2</sup>  
28,5 Kg

**PAL**

32 Cx  
46,08 m<sup>2</sup>  
1.010 Kg

**PAL**

40 Cx  
57,60 m<sup>2</sup>  
1.160 Kg

Degraus rodapés e peças especiais  
na página 264 a 275.

# Armani Oro Bianco Polido



60x60 PORCELÂNICO

C22/31

Série: **Armani Oro Bianco - Polido**

Ref.: RA6060ORBP



5 606779 219145



60x120 PORCELÂNICO

C30/42

Série: **Armani Oro Bianco - Polido**

Ref.: RA60120ORBP



5 606779 200327



120x120 PORCELÂNICO

C40/56

Série: **Armani Oro Bianco - Polido**

Ref.: RA120120ORBP



5 606779 215864





Porcelânico Esmaltado  
Glazed tiles, Grès cérame émaillé,  
Feinsteinzeug Glasiert, Porcelánico esmaltado



Retificado  
Rectified / Rectifié / Verarbeitet / Rectificado



Pisos e Paredes  
Floor and Walls / Sols et Murs  
Wandfliesen und Bodenfliesen / Pisos y Paredes



Variação Média V3  
Average tone variation / Variation moyenne  
Durchschnittliche Tonhöhenchwankung  
Variación media de tono



Resistente ao gelo  
Frost resistant / Résistant au gel  
Frostbeständig / Resistente al hielo



Espessura  
Thickness / Épaisseur / Dicke / Grosor

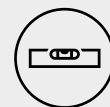

Recomendamos o uso de niveladores  
Recommended levelers / croisillons auto-nivellants conseillé  
Empfohlene Richtmaschinen / Niveladores recomendados

**120x120**

2 Pcs  
2,88 m<sup>2</sup>  
60 Kg

**60x60**

4 Pcs  
1,44 m<sup>2</sup>  
28,5 Kg

**PAL**

28 Cx  
80,64 m<sup>2</sup>  
1.695 Kg

**PAL**

40 Cx  
57,60 m<sup>2</sup>  
1.160 Kg

Degraus rodapés e peças especiais  
na página 264 a 275.

## Armani Oro Bianco Mate

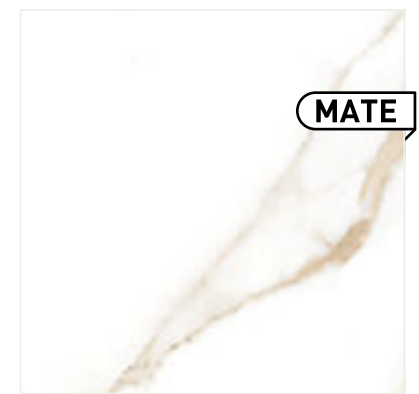

**MATE**

**60x60 PORCELÂNICO**

**C20/28**

Série: **Armani Oro Bianco - Mate**

Ref.: RA6060ORBMT



5 606779 253057



**BBY SAT**

**60x120 PORCELÂNICO**

**C28/40**

Série: **Armani Oro Bianco - Baby Satin**

Ref.: RA60120ORBBS



5 606779 229885

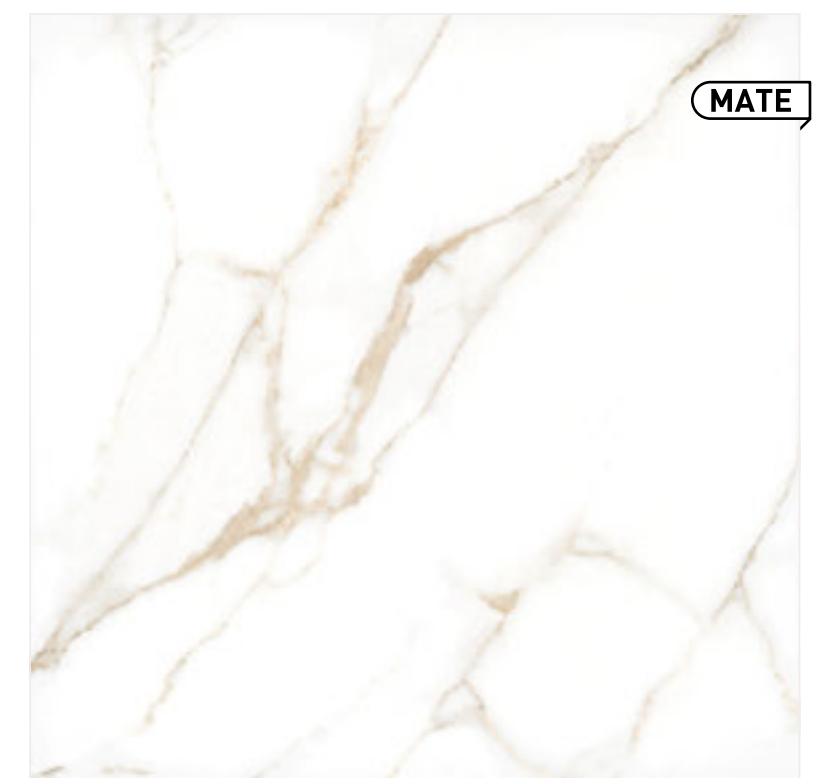

**MATE**

**120x120 PORCELÂNICO**

**C36/50**

Série: **Armani Oro Bianco - Mate**

Ref.: RA120120ORBMT



5 606779 253040





Porcelânico Esmaltado  
Glazed tiles / Grès cérame émaillé,  
Feinsteinzeug Glasiert, Porcelânico esmaltado



Retificado  
Rectified / Rectifié / Verarbeitet / Rectificado



Pisos e Paredes  
Floor and Walls / Sols et Murs  
Wandfliesen und Bodenfliesen / Pisos y Paredes



Variação Média V3  
Average tone variation / Variation moyenne  
Durchschnittliche Tonhöhen schwankung  
Variación media de tono



Resistente ao gelo  
Frost resistant / Résistant au gel  
Frostbeständig / Resistente al hielo



Espessura  
Thickness / Épaisseur / Dicke / Grosor



Recomendamos o uso de niveladores  
Recommended levelers / craisillons auto-nivellants conseillé  
Empfohlene Richtmaschinen / Niveladores recomendados

**120x120**

2 Pcs  
2,88 m<sup>2</sup>  
60 Kg

**60x120**

2 Pcs  
1,44 m<sup>2</sup>  
30,6 Kg

**60x60**

4 Pcs  
1,44 m<sup>2</sup>  
28,5 Kg

**PAL**

28 Cx  
80,64 m<sup>2</sup>  
1.695 Kg

**PAL**

32 Cx  
46,08 m<sup>2</sup>  
1.010 Kg

**PAL**

40 Cx  
57,60 m<sup>2</sup>  
1.160 Kg

Degraus rodapés e peças especiais  
na página 264 a 275.

## Armani Calacata Venattino Polido



60x60 PORCELÂNICO

C22/31

Série: **Armani Calacata Venattino - Polido**

Ref.: RA6060VTIP



5 606779 204615

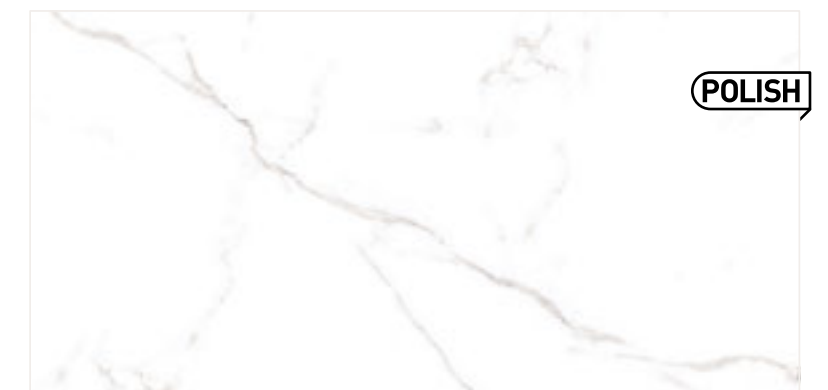

60x120 PORCELÂNICO

C30/42

Série: **Armani Calacata Venattino - Polido**

Ref.: RA60120VTIP



5 606779 203946

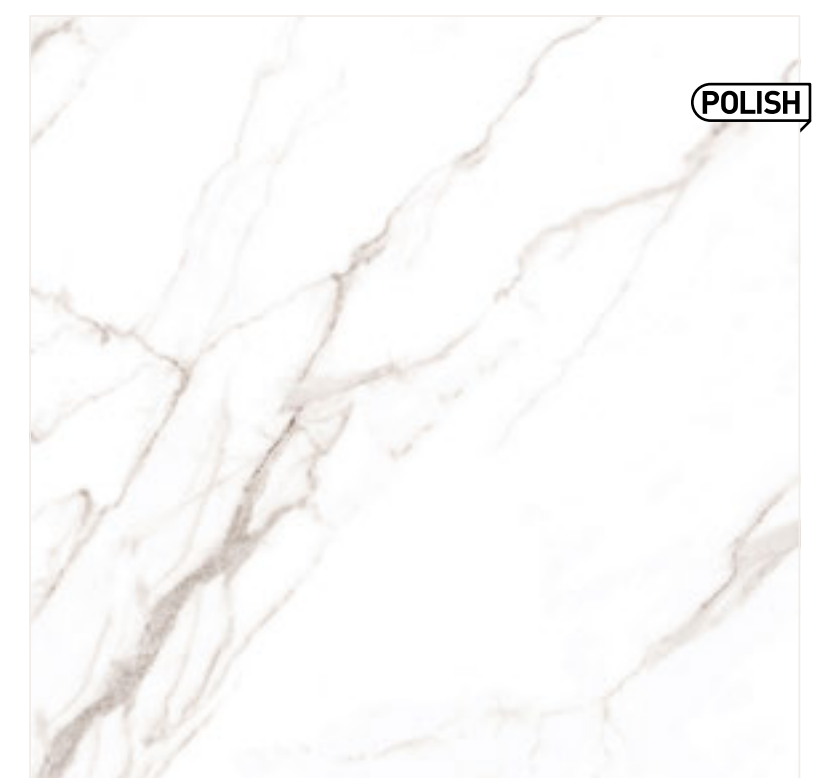

120x120 PORCELÂNICO

C40/56

Série: **Armani Calacata Venattino - Polido**

Ref.: RA120120VTIP



5 606779 216045





Porcelânico Esmaltado  
Glazed tiles, Grès cérame émaillé,  
Feinsteinzeug Glasiert, Porcelánico esmaltado



Retificado  
Rectified / Rectifié / Verarbeitet / Rectificado



Pisos e Paredes  
Floor and Walls / Sols et Murs  
Wandfliesen und Bodenfliesen / Pisos y Paredes



Variação Média V3  
Average tone variation / Variation moyenne  
Durchschnittliche Tonhöhenchwankung  
Variación media de tono



Resistente ao gelo  
Frost resistant / Résistant au gel  
Frostbeständig / Resistente al hielo



Espessura  
Thickness / Épaisseur / Dicke / Grosor

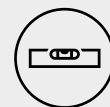

Recomendamos o uso de niveladores  
Recommended levelers / craisillons auto-nivellants conseillé  
Empfohlene Richtmaschinen / Niveladores recomendados



PCS  
2 Pcs  
1,44 m<sup>2</sup>  
31 Kg



PAL  
32 Cx  
46,08 m<sup>2</sup>  
1.010 Kg

Degraus rodapés e peças especiais  
na página 264 a 275.

## Armani Calacata Venattino Mate



60x60 PORCELÂNICO

C20/28

Série: **Armani Calacata Venattino - Mate**

Ref.: RA6060VTIMT



5 606779 253033

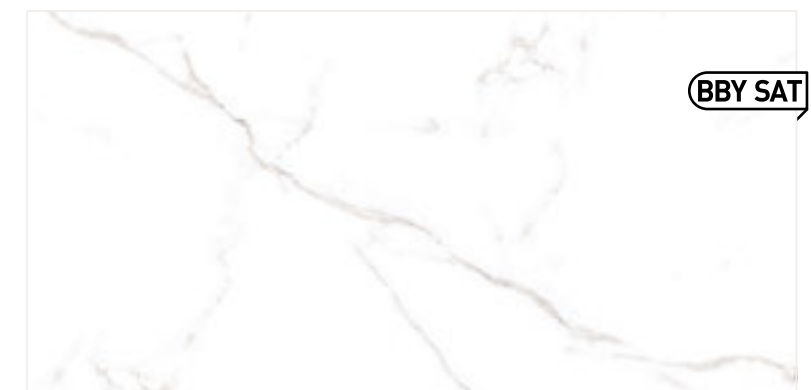

60x120 PORCELÂNICO

C28/40

Série: **Armani Calacata Venattino - Baby Satin**

Ref.: RA60120VTIPBBS



5 606779 249234

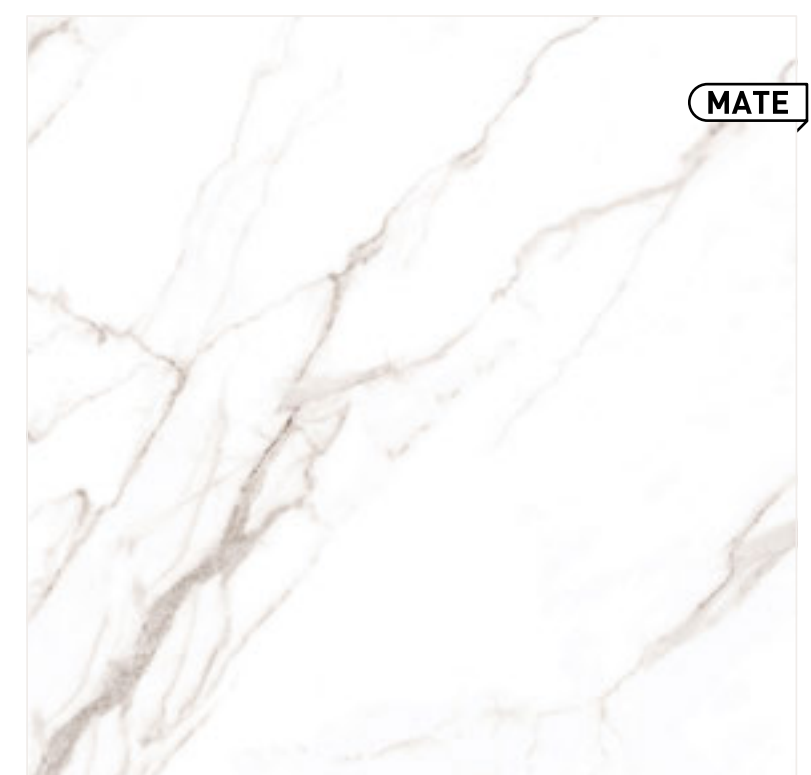

120x120 PORCELÂNICO

C36/50

Série: **Armani Calacata Venattino - Mate**

Ref.: RA120120VTIMT



5 606779 252852





Porcelânico Esmaltado  
Glazed tiles, Grès cérame émaillé,  
Feinsteinzeug Glasiert, Porcelánico esmaltado



Retificado  
Rectified / Rectifié / Verarbeitet / Rectificado



Pisos e Paredes  
Floor and Walls / Sols et Murs  
Wandfliesen und Bodenfliesen / Pisos y Paredes



Variação Média V2



Resistente ao gelo  
Frost resistant / Résistant au gel  
Frostbeständig / Resistente al hielo



Espessura  
Thickness / Épaisseur / Dicke / Grosor



Recomendamos o uso de niveladores  
Recommended levelers / craillons auto-nivellants conseillé  
Empfohlene Richtmaschinen / Niveladores recomendados



PCS  
2 Pcs  
1,44 m<sup>2</sup>  
31 Kg



PAL  
32 Cx  
46,08 m<sup>2</sup>  
1.007 Kg

Degraus rodapés e peças especiais  
na página 264 a 275.

## Magnum Venato



60x120 PORCELÂNICO

C30/42

Série: **Magnum Venato - Polido**

Ref.: RM60120VEP



5 606779 253200

## Magnum Tarsia White

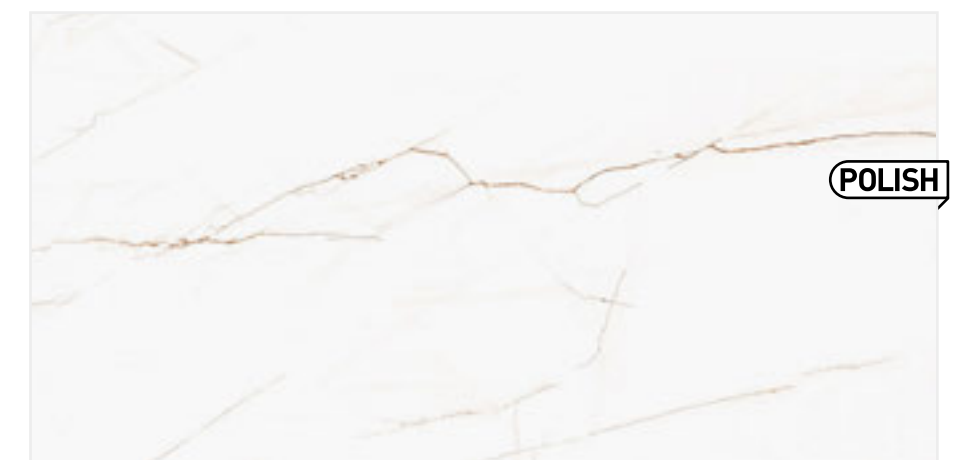

60x120 PORCELÂNICO

C30/42

Série: **Magnum Tarsia White - Polido**

Ref.: RM60120TAWP



5 606779 212368





PE

Porcelânico Esmaltado  
Glazed tiles, Grès cérame émaillé,  
Feinsteinzeug Glasiert, Porcelánico esmaltado

RET

Retificado  
Rectified / Rectifié / Verarbeitet / Rectificado



Pisos e Paredes  
Floor and Walls / Sols et Murs  
Wandfliesen und Bodenfliesen / Pisos y Paredes



Variação Média V3  
Average tone variation / Variation moyenne  
Durchschnittliche Tonhöhenchwankung  
Variación media de tono



Resistente ao gelo  
Frost resistant / Résistant au gel  
Frostbeständig / Resistente al hielo



Espessura  
Thickness / Épaisseur / Dicke / Grosor



Recomendamos o uso de niveladores  
Recommended levelers / craisillons auto-nivellants conseillé  
Empfohlene Richtmaschinen / Niveladores recomendados



PCS  
2 Pcs  
1,44 m<sup>2</sup>  
31 Kg



PAL  
30 Cx  
43,20 m<sup>2</sup>  
945 Kg

Degraus rodapés e peças especiais  
na página 264 a 275.

## Calacatta Titanio

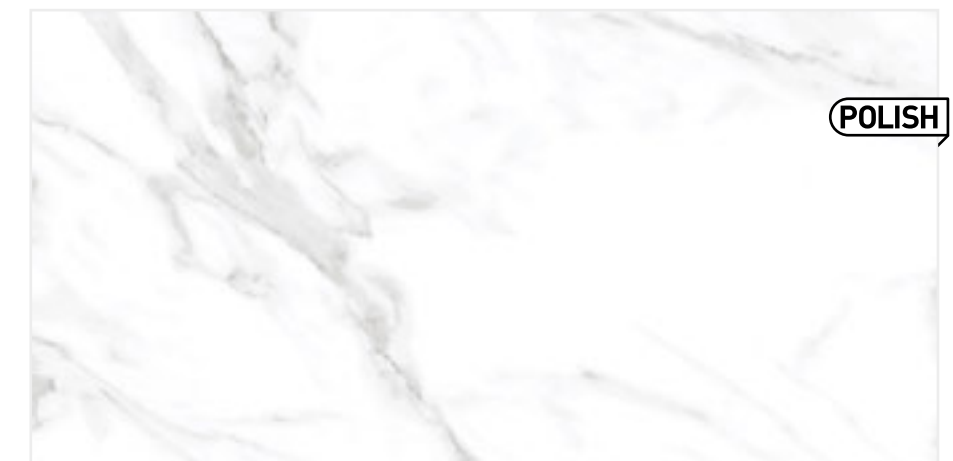

60x120 PORCELÂNICO

C30/42

Série: **Calacatta Titanio - Polido**

Ref.: RC60120CALTIT



5 606779 209344

## Marmy White Arabesk

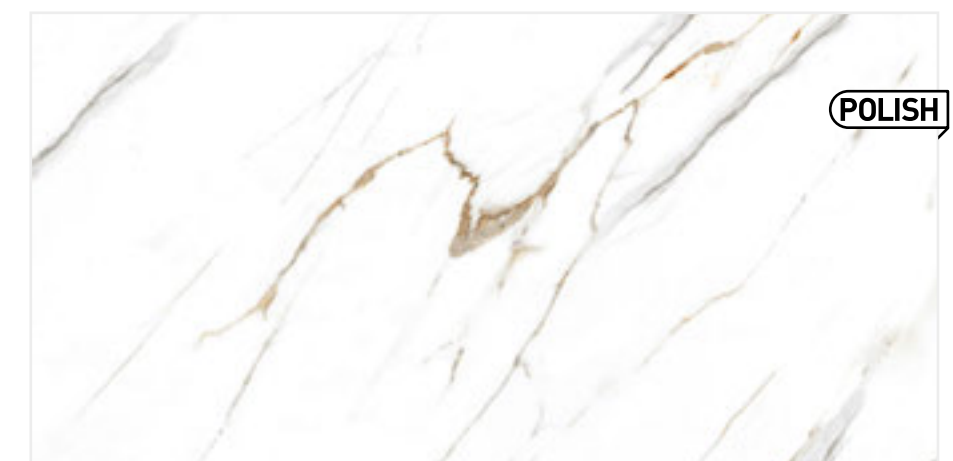

60x120 PORCELÂNICO

C30/42

Série: **Marmy White Arabesk - Polido**

Ref.: RBP60120WAP



5 606779 210289





Porcelânico Esmaltado  
Glazed tiles, Grès cérame émaillé,  
Feinsteinzeug Glasiert, Porcelánico esmaltado



Retificado  
Rectified / Rectifié / Verarbeitet / Rectificado



Pisos e Paredes  
Floor and Walls / Sols et Murs  
Wandfliesen und Bodenfliesen / Pisos y Paredes



Variação Média V3  
Average tone variation / Variation moyenne  
Durchschnittliche Tonhöhenchwankung  
Variación media de tono



Resistente ao gelo  
Frost resistant / Résistant au gel  
Frostbeständig / Resistente al hielo



Espessura  
Thickness / Épaisseur / Dicke / Grosor



Recomendamos o uso de niveladores  
Recommended levelers / craisillons auto-nivellants conseillé  
Empfohlene Richtmaschinen / Niveladores recomendados

**60x120**

2 Pcs  
1,44 m<sup>2</sup>  
31 Kg

**60x60**

4 Pcs  
1,44 m<sup>2</sup>  
28,5 Kg

**PAL**

30 Cx  
43,20 m<sup>2</sup>  
945 Kg

**PAL**

40 Cx  
57,60 m<sup>2</sup>  
1.155 Kg

Degraus rodapés e peças especiais  
na página 264 a 275.

# Statuario White



**60x120 PORCELÂNICO**

**C30/42**

Série: **Statuario White - Polido**

Ref.: R60120STW



5 606779 206701

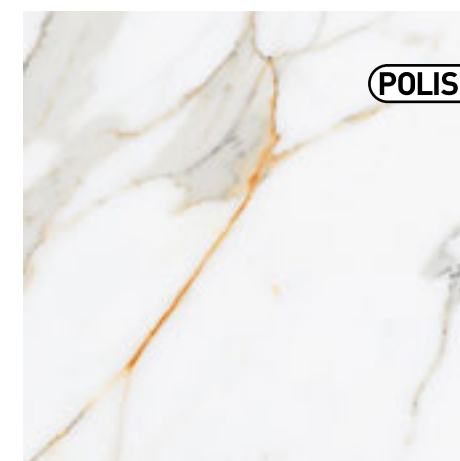

**60x60 PORCELÂNICO**

**C22/31**

Série: **Statuario White - Polido**

Ref.: R6060STW



5 606779 252906





Porcelânico Esmaltado  
Glazed tiles, Grès cérame émaillé,  
Feinsteinzeug Glasiert, Porcelánico esmaltado



Retificado  
Rectified / Rectifié / Verarbeitet / Rectificado



Pisos e Paredes  
Floor and Walls / Sols et Murs  
Wandfliesen und Bodenfliesen / Pisos y Paredes



Variação Média V3  
Average tone variation / Variation moyenne  
Durchschnittliche Tonhöhenchwankung  
Variación media de tono



Resistente ao gelo  
Frost resistant / Résistant au gel  
Frostbeständig / Resistente al hielo



Espessura  
Thickness / Épaisseur / Dicke / Grosor

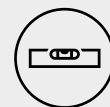

Recomendamos o uso de niveladores  
Recommended levelers / croisillons auto-nivellants conseillé  
Empfohlene Richtmaschinen / Niveladores recomendados



PCS  
2 Pcs  
1,44 m<sup>2</sup>  
31 Kg



PAL  
32 Cx  
46,08 m<sup>2</sup>  
1.010 Kg

Degraus rodapés e peças especiais  
na página 264 a 275.

## Stone C. Grey

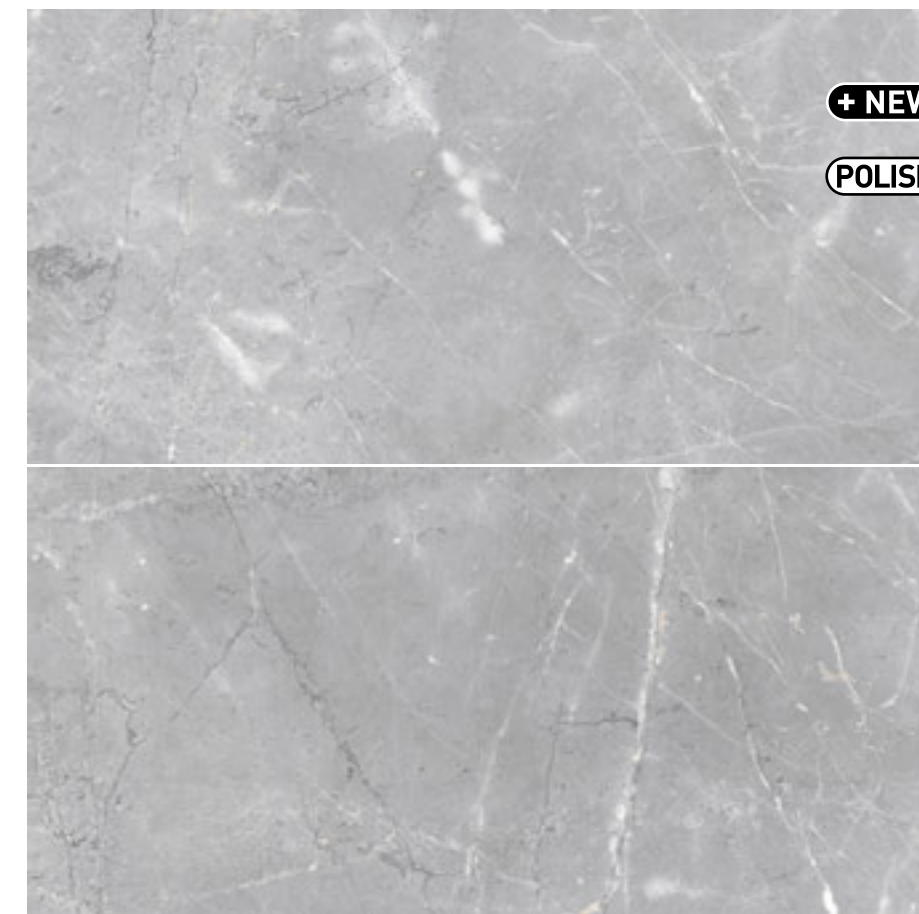

+ NEW

POLISH

60x120 PORCELÂNICO

C30/42

Série: Stone C. Grey - Polido

Ref.: RSC60120CGREP



5 606779 253217

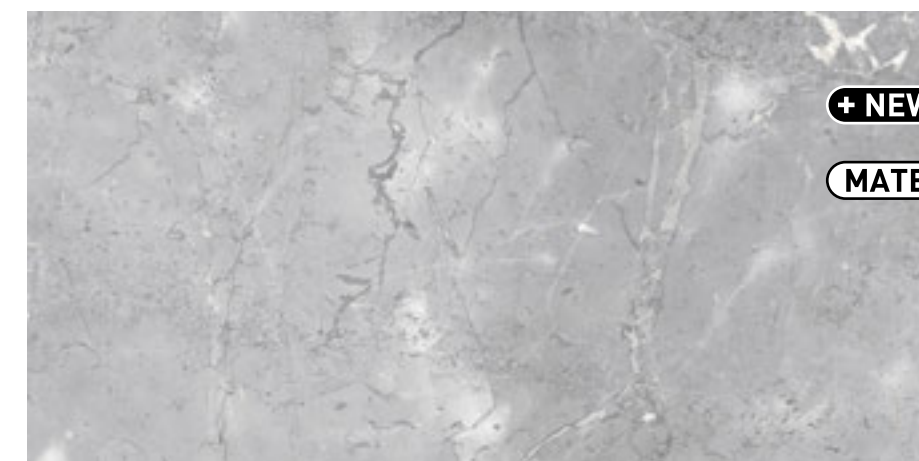

+ NEW

MATE

60x120 PORCELÂNICO

C26/37

Série: Stone C. Grey - Mate

Ref.: RSC60120CGREMT



5 606779 253224





Porcelânico Esmaltado  
Glazed tiles, Grès cérame émaillé,  
Feinsteinzeug Glasiert, Porcelánico esmaltado



Retificado  
Rectified / Rectifié / Verarbeitet / Rectificado



Pisos e Paredes  
Floor and Walls / Sols et Murs  
Wandfliesen und Bodenfliesen / Pisos y Paredes



Variação Média V3  
Average tone variation / Variation moyenne  
Durchschnittliche Tonhöhen schwankung  
Variación media de tono



Resistente ao gelo  
Frost resistant / Résistant au gel  
Frostbeständig / Resistente al hielo



Espessura  
Thickness / Épaisseur / Dicke / Grosor

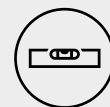

Recomendamos o uso de niveladores  
Recommended levelers / craisillons auto-nivellants conseillé  
Empfohlene Richtmaschinen / Niveladores recomendados



PCS  
2 Pcs  
1,44 m<sup>2</sup>  
31 Kg



PAL  
32 Cx  
46,08 m<sup>2</sup>  
1.010 Kg

Degraus rodapés e peças especiais  
na página 264 a 275.

## Stone F. Gris

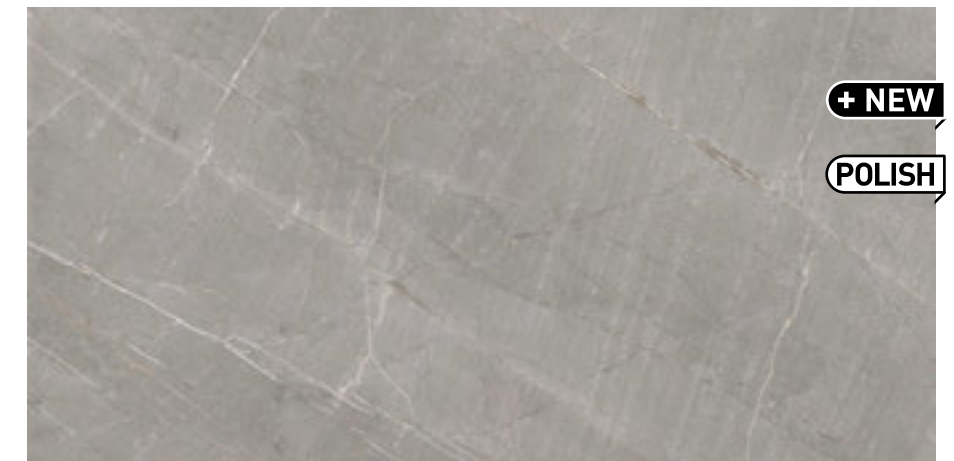

+ NEW

POLISH



60x120 PORCELÂNICO

C30/42

Série: Stone F. Gris - Polido

Ref.: RSC60120FGRIP



5 606779 253408

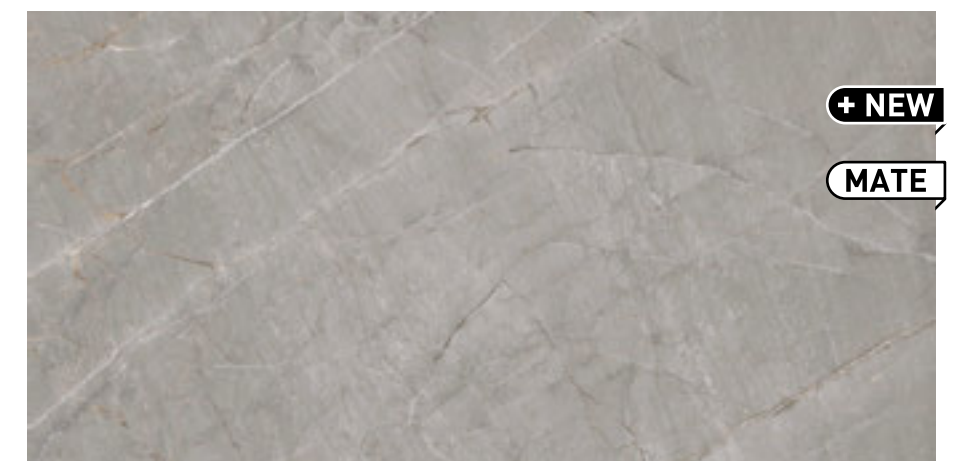

+ NEW

MATE

60x120 PORCELÂNICO

C26/37

Série: Stone F. Gris - Mate

Ref.: RSC60120FGRIMT



5 606779 253415





Porcelânico Esmaltado  
Glazed tiles, Grès cérame émaillé,  
Feinsteinzeug Glasiert, Porcelánico esmaltado



Retificado  
Rectified / Rectifié / Verarbeitet / Rectificado



Pisos e Paredes  
Floor and Walls / Sols et Murs  
Wandfliesen und Bodenfliesen / Pisos y Paredes



Variação Média V3  
Average tone variation / Variation moyenne  
Durchschnittliche Tonhöhen schwankung  
Variación media de tono



Resistente ao gelo  
Frost resistant / Résistant au gel  
Frostbeständig / Resistente al hielo



Espessura  
Thickness / Épaisseur / Dicke / Grosor



Recomendamos o uso de niveladores  
Recommended levelers / craisillons auto-nivellants conseillé  
Empfohlene Richtmaschinen / Niveladores recomendados



**60x120**  
2 Pcs  
1,44 m<sup>2</sup>  
30,6 Kg



**60x60**  
4 Pcs  
1,44 m<sup>2</sup>  
28,5 Kg



**PAL**  
32 Cx  
46,08 m<sup>2</sup>  
1.010 Kg



**PAL**  
40 Cx  
57,60 m<sup>2</sup>  
1.155 Kg

Degraus rodapés e peças especiais  
na página 264 a 275.

## Marmorizzato Steel



**60x120 PORCELÂNICO**

**C30/42**

Série: **Marmorizzato Steel - Polido**

Ref.: **RMZ60120STLP**



5 606779 208835



**60x60 PORCELÂNICO**

**C22/31**

Série: **Marmorizzato Steel - Polido**

Ref.: **RMZ6060STLP**



5 606779 208743





Porcelânico Esmaltado  
Glazed tiles / Grès cérame émaillé,  
Feinsteinzeug Glasiert, Porcelánico esmaltado



Retificado  
Rectified / Rectifié / Verarbeitet / Rectificado



Pisos e Paredes  
Floor and Walls / Sols et Murs  
Wandfliesen und Bodenfliesen / Pisos y Paredes



Variação Média V3  
Average tone variation / Variation moyenne  
Durchschnittliche Tonhöhenchwankung  
Variación media de tono



Resistente ao gelo  
Frost resistant / Résistant au gel  
Frostbeständig / Resistente al hielo



Espessura  
Thickness / Épaisseur / Dicke / Grosor



Recomendamos o uso de niveladores  
Recommended levelers / craisillons auto-nivellants conseillé  
Empfohlene Richtmaschinen / Niveladores recomendados

2 Pcs	4 Pcs
1,44 m <sup>2</sup>	1,44 m <sup>2</sup>
30,6 Kg	28,5 Kg

32 Cx	40 Cx
46,08 m <sup>2</sup>	57,60 m <sup>2</sup>
1.010 Kg	1.155 Kg

Degraus rodapés e peças especiais  
na página 264 a 275.

# Marmorizzato Grey



60x120 PORCELÂNICO

C30/42

Série: **Marmorizzato Grey - Polido**

Ref.: RMZ60I20GRP



5 606779 208828

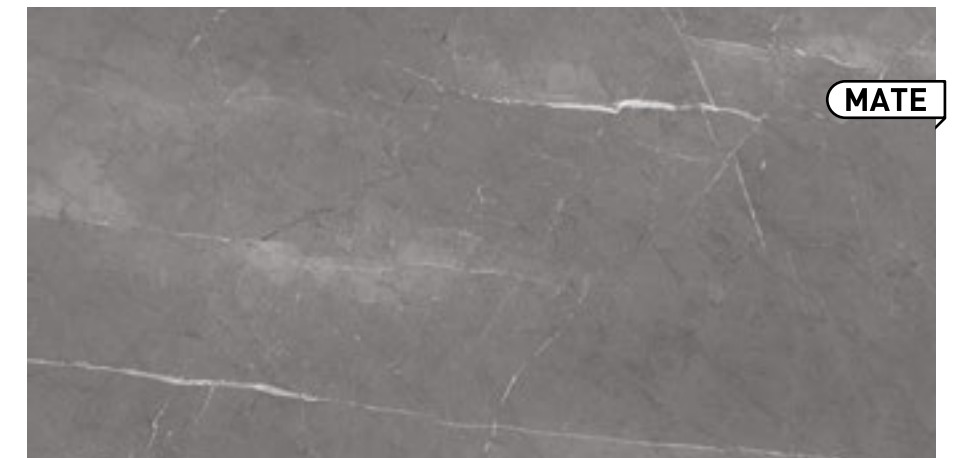

60x120 PORCELÂNICO

C26/37

Série: **Marmorizzato Grey - Mate**

Ref.: RMZ60I20GRM



5 606779 228185



60x60 PORCELÂNICO

C22/31

Série: **Marmorizzato Grey - Polido**

Ref.: RMZ6060GRP



5 606779 208736





Porcelânico Esmaltado  
Glazed tiles, Grès cérame émaillé,  
Feinsteinzeug Glasiert, Porcelánico esmaltado



Retificado  
Rectified / Rectifié / Verarbeitet / Rectificado



Pisos e Paredes  
Floor and Walls / Sols et Murs  
Wandfliesen und Bodenfliesen / Pisos y Paredes



Variação Média V2



Resistente ao gelo  
Frost resistant / Résistant au gel  
Frostbeständig / Resistente al hielo



Espessura  
Thickness / Épaisseur / Dicke / Grosor



Recomendamos o uso de niveladores  
Recommended levelers / craisillons auto-nivellants conseillé  
Empfohlene Richtmaschinen / Niveladores recomendados



PCS  
2 Pcs  
1,44 m<sup>2</sup>  
31 Kg



PAL  
32 Cx  
46,80 m<sup>2</sup>  
1.010 Kg

Degraus rodapés e peças especiais  
na página 264 a 275.

## Armani Bosco Silver



60x120 PORCELÂNICO

C30/42

Série: **Armani Bosco Silver - Polido**

Ref.: RA60120BOSIL



5 606779 202369

## Armani Bosco Nude

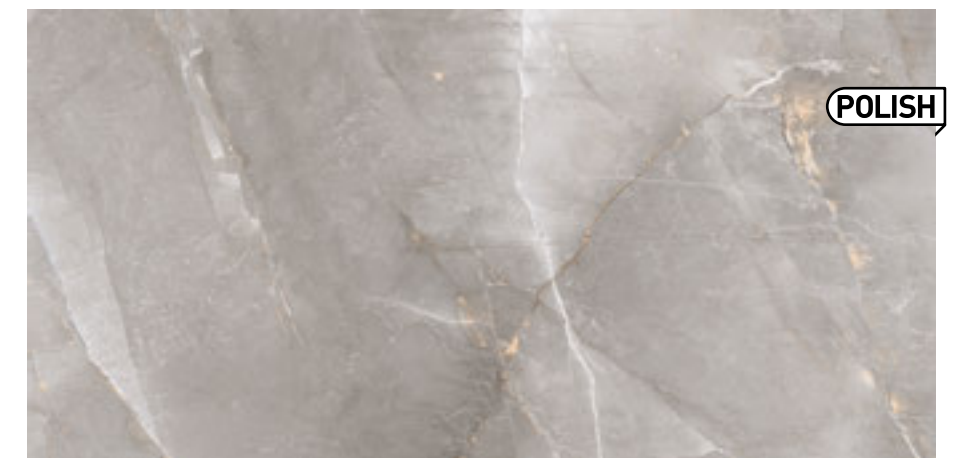

60x120 PORCELÂNICO

C30/42

Série: **Armani Bosco Nude - Polido**

Ref.: RA60120BONUD



5 606779 209320





PE

Porcelânico Esmaltado  
Glazed tiles / Grès cérame émaillé,  
Feinsteinzeug Glasiert, Porcelánico esmaltado

RET

Retificado  
Rectified / Rectifié / Verarbeitet / Rectificado

Pisos e Paredes  
Floor and Walls / Sols et Murs  
Wandfliesen und Bodenfliesen / Pisos y Paredes

Variação Média V3  
Average tone variation / Variation moyenne  
Durchschnittliche Tonhöhen-schwankung  
Variación media de tono

Resistente ao gelo  
Frost resistant / Résistant au gel  
Frostbeständig / Resistente al hielo

Espessura  
Thickness / Épaisseur / Dicke / Grosor

Recomendamos o uso de niveladores  
Recommended levelers / craisillons auto-nivellants conseillé  
Empfohlene Richtmaschinen / Niveladores recomendados

PCS  
2 Pcs  
1,44 m<sup>2</sup>  
31 Kg

PAL  
32 Cx  
46,80 m<sup>2</sup>  
1.010 Kg

Degraus rodapés e peças especiais  
na página 264 a 275.

## Marmy Silver



60x120 PORCELÂNICO

C30/42

Série: **Marmy Silver - Polido**

Ref.: RM60120SP



5 606779 163226

## Marmy S. Laurent

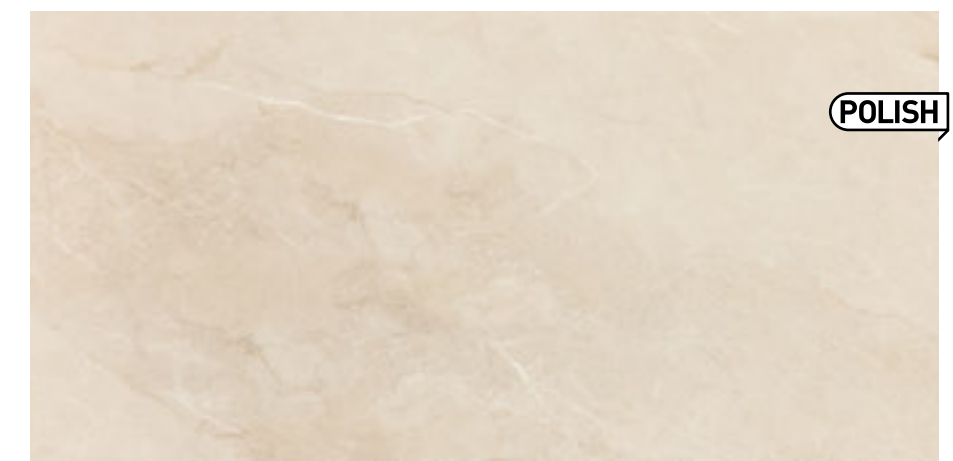

60x120 PORCELÂNICO

C30/42

Série: **Marmy S. Laurent - Polido**

Ref.: RM60120SLP



5 606779 163219



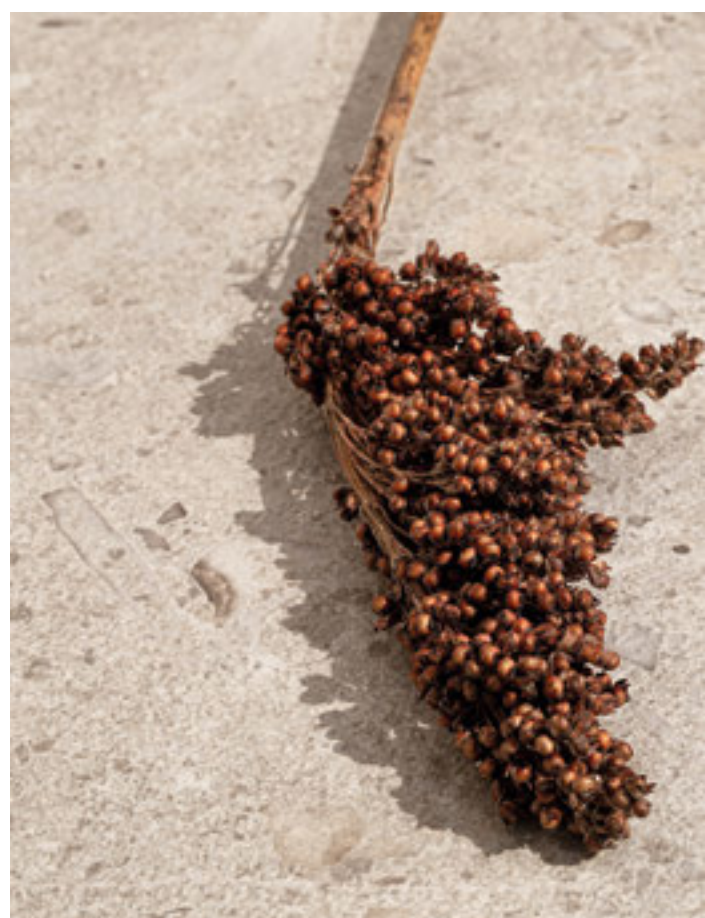

Porcelânico Esmaltado  
Glazed tiles, Grès cérame émaillé,  
Feinsteinzeug Glasiert, Porcelánico esmaltado



Retificado  
Rectified / Rectifié / Verarbeitet / Rectificado



Pisos e Paredes  
Floor and Walls / Sols et Murs  
Wandfliesen und Bodenfliesen / Pisos y Paredes



Variação Média V2



Resistente ao gelo  
Frost resistant / Résistant au gel  
Frostbeständig / Resistente al hielo



Espessura  
Thickness / Épaisseur / Dicke / Grosor

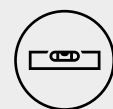

Recomendamos o uso de niveladores  
Recommended levelers / craissillons auto-nivellants conseillé  
Empfohlene Richtmaschinen / Niveladores recomendados



PCS  
2 Pcs  
1,43 m<sup>2</sup>  
36 Kg



PAL  
26 Cx  
37,18 m<sup>2</sup>  
951 Kg

Degraus rodapés e peças especiais  
na página 264 a 275.

Yass

PORCELÂNICOS

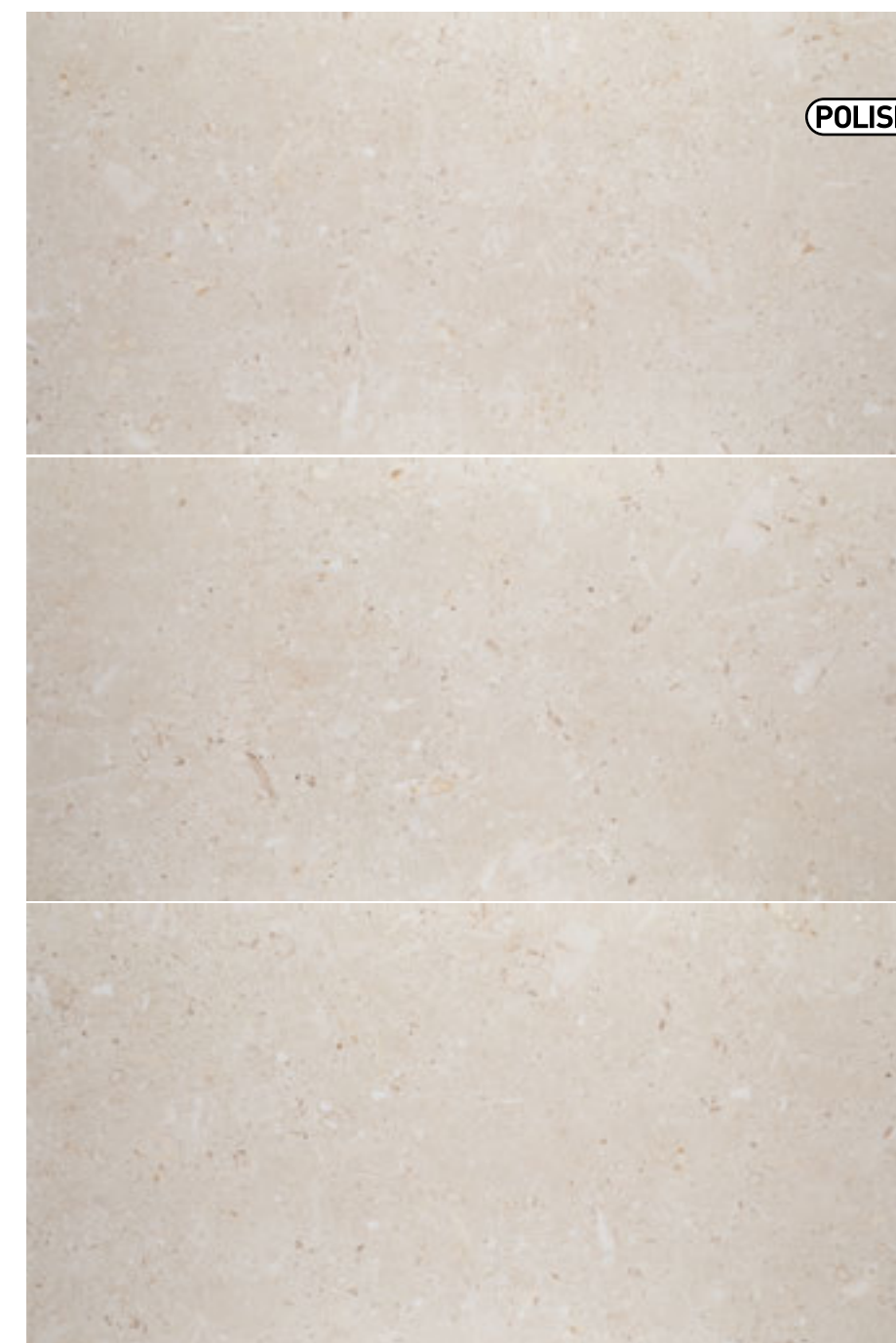

60x120 PORCELÂNICO

C30/42

Série: **Yass White - Polido**

Ref.: RY60120WHP



5 606779 204219





PE

Porcelânico Esmaltado  
Glazed tiles / Grès cérame émaillé,  
Feinsteinzeug Glasiert, Porcelánico esmaltado

RET

Retificado  
Rectified / Rectifié / Verarbeitet / Rectificado



Pisos e Paredes  
Floor and Walls / Sols et Murs  
Wandfliesen und Bodenfliesen / Pisos y Paredes



Variação Média V3  
Average tone variation / Variation moyenne  
Durchschnittliche Tonhöhen schwankung  
Variación media de tono



Resistente ao gelo  
Frost resistant / Résistant au gel  
Frostbeständig / Resistente al hielo



Espessura  
Thickness / Épaisseur / Dicke / Grosor



Recomendamos o uso de niveladores  
Recommended levelers / craisillons auto-nivellants conseillé  
Empfohlene Richtmaschinen / Niveladores recomendados



PCS

2 Pcs

1,44 m<sup>2</sup>

30,6 Kg



PAL

32 Cx

46,08 m<sup>2</sup>

1.000 Kg

Degraus rodapés e peças especiais  
na página 264 a 275.

## Pietra Morella Nude



60x120 PORCELÂNICO

C30/42

Série: Pietra Morella Nude - Polido

Ref.: RPM60120NUDP



5 606779 208811





PE

Porcelânico Esmaltado  
Glazed tiles / Grès cérame émaillé,  
Feinsteinzeug Glasiert, Porcelânico esmaltado

RET

Retificado  
Rectified / Rectifié / Verarbeitet / Rectificado



Pisos e Paredes  
Floor and Walls / Sols et Murs  
Wandfliesen und Bodenfliesen / Pisos y Paredes



Variação Média V3  
Average tone variation / Variation moyenne  
Durchschnittliche Tonhöhenchwankung  
Variación media de tono



Resistente ao gelo  
Frost resistant / Résistant au gel  
Frostbeständig / Resistente al hielo



Espessura  
Thickness / Épaisseur / Dicke / Grosor



Recomendamos o uso de niveladores  
Recommended levelers / craisillons auto-nivellants conseillé  
Empfohlene Richtmaschinen / Niveladores recomendados

PCS

2 Pcs  
1,44 m<sup>2</sup>  
31 Kg

PAL

30 Cx  
43,20 m<sup>2</sup>  
945 Kg

Degraus rodapés e peças especiais  
na página 264 a 275.

## Pietra Morella Peris



60x120 PORCELÂNICO

C30/42

Série: **Pietra Morella Peris - Alto Brilho**

Ref.: RPM60120PRSP



5 606779 216601

## Pietra Morella Bronze

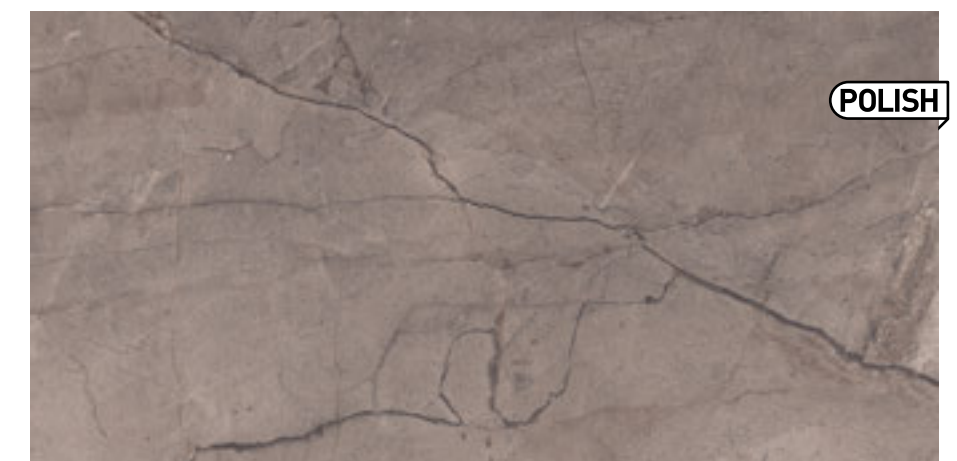

60x120 PORCELÂNICO

C30/42

Série: **Pietra Morella Bronze - Polido**

Ref.: RPM60120BROP



5 606779 208804





Porcelânico Esmaltado  
Glazed tiles, Grès cérame émaillé,  
Feinsteinzeug Glasiert, Porcelánico esmaltado



Retificado  
Rectified / Rectifié / Verarbeitet / Rectificado



Pisos e Paredes  
Floor and Walls / Sols et Murs  
Wandfliesen und Bodenfliesen / Pisos y Paredes



Variação Média V3  
Average tone variation / Variation moyenne  
Durchschnittliche Tonhöhenchwankung  
Variación media de tono



Resistente ao gelo  
Frost resistant / Résistant au gel  
Frostbeständig / Resistente al hielo



Espessura  
Thickness / Épaisseur / Dicke / Grosor



Recomendamos o uso de niveladores  
Recommended levelers / craisillons auto-nivellants conseillé  
Empfohlene Richtmaschinen / Niveladores recomendados



60x120  
4 Pcs  
2,88 m<sup>2</sup>  
32 Kg



32 Cx  
92,16 m<sup>2</sup>  
1.040 Kg

Degraus rodapés e peças especiais  
na página 264 a 275.

## Esperda Grey Extra Fino



POLISH

60x120 PORCELÂNICO EXTRA FINO

C38/54

Série: **Esperda Grey - Polido**

Ref.: RS60120EG



5 606779 196309





PE

Porcelânico Esmaltado  
Glazed tiles, Grès cérame émaillé,  
Feinsteinzeug Glasiert, Porcelánico esmaltado

RET

Retificado  
Rectified / Rectifié / Verarbeitet / Rectificado

Pisos e Paredes  
Floor and Walls / Sols et Murs  
Wandfliesen und Bodenfliesen / Pisos y Paredes

Variação Média V3  
Average tone variation / Variation moyenne  
Durchschnittliche Tonhöhenchwankung  
Variación media de tono

Resistente ao gelo  
Frost resistant / Résistant au gel  
Frostbeständig / Resistente al hielo

Espessura  
Thickness / Épaisseur / Dicke / Grosor

Recomendamos o uso de niveladores  
Recommended levelers / croisillons auto-nivellants conseillé  
Empfohlene Richtmaschinen / Niveladores recomendados

**60x120**  
4 Pcs  
2,88 m<sup>2</sup>  
32 Kg

**Grey**  
3 Pcs  
2,16 m<sup>2</sup>  
26 Kg

**PAL**  
32 Cx  
92,16 m<sup>2</sup>  
1.040 Kg

**PAL**  
34 Cx  
73,44 m<sup>2</sup>  
900 Kg

Degraus rodapés e peças especiais  
na página 264 a 275.

## Solid Branco & Cinza Extra Fino

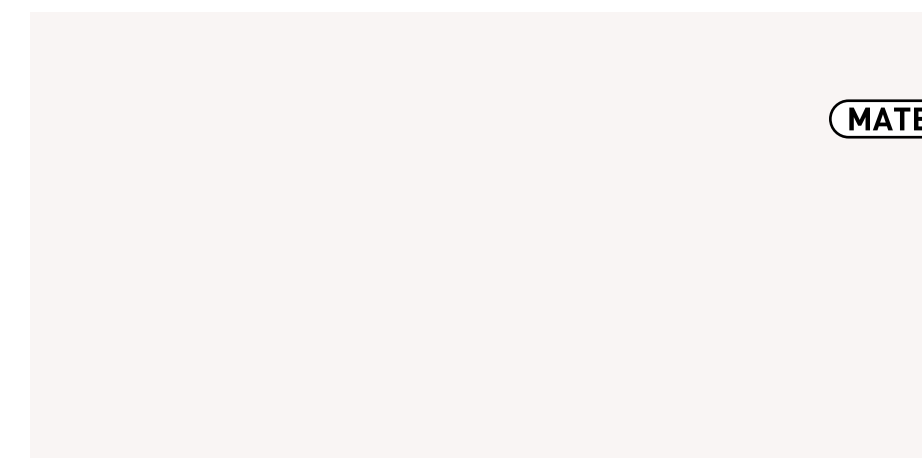

60x120 PORCELÂNICO

**C38/54**

Série: **Solid White - Mate**

Ref.: REF60120SPWMT



5 606779 193261



60x120 PORCELÂNICO - 4,8mm

**C38/54**

Série: **Solid Grey - Polido**

Ref.: RSC60120SGP



5 606779 180070

60x120 PORCELÂNICO - 4,8mm

**C38/54**

Série: **Solid Grey - Mate**

Ref.: RSC60120SGM



5 606779 180056





Porcelânico Esmaltado  
Glazed tiles / Grès cérame émaillé,  
Feinsteinzeug Glasiert, Porcelánico esmaltado



Retificado  
Rectified / Rectifié / Verarbeitet / Rectificado



Pisos e Paredes  
Floor and Walls / Sols et Murs  
Wandfliesen und Bodenfliesen / Pisos y Paredes



Variação Média V1  
Average tone variation / Variation moyenne  
Durchschnittliche Tonhöhen-schwankung  
Variación media de tono



Resistente ao gelo  
Frost resistant / Résistant au gel  
Frostbeständig / Resistente al hielo



9 mm  
Espessura  
Thickness / Épaisseur / Dicke / Grosor



Recomendamos o uso de niveladores  
Recommended levelers / craillons auto-nivellants conseillé  
Empfohlene Richtmaschinen / Niveladores recomendados

<b>120x120</b>	<b>60x120</b>	<b>60x60</b>
2 Pcs	2 Pcs	4 Pcs
2,88 m <sup>2</sup>	1,44 m <sup>2</sup>	1,44 m <sup>2</sup>
60 Kg	30,6 Kg	28,5 Kg

<b>PAL</b>	<b>PAL</b>	<b>PAL</b>
28 Cx	32 Cx	40 Cx
80,64 m <sup>2</sup>	46,08 m <sup>2</sup>	57,60 m <sup>2</sup>
1.695 Kg	1.010 Kg	1.155 Kg

Degraus rodapés e peças especiais  
na página 264 a 275.

# Blanco Puro Polish



60x60 PORCELÂNICO

C22/31

Série: **Blanco Puro - Polish**

Ref.: RBP6060

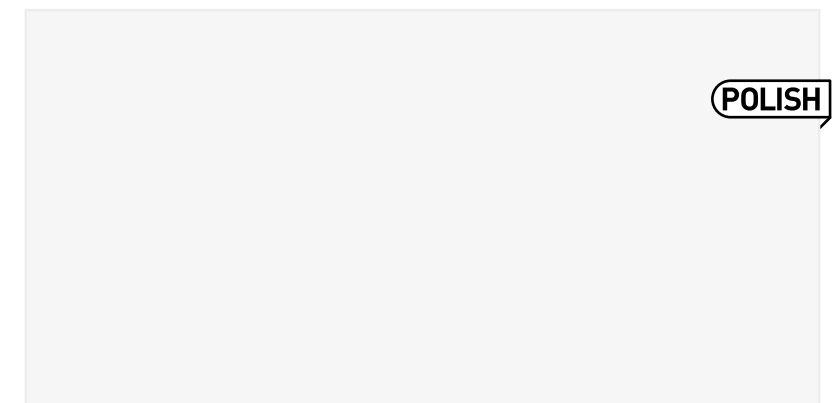

60x120 PORCELÂNICO

C32/45

Série: **Blanco Puro - Polish**

Ref.: RBP60120

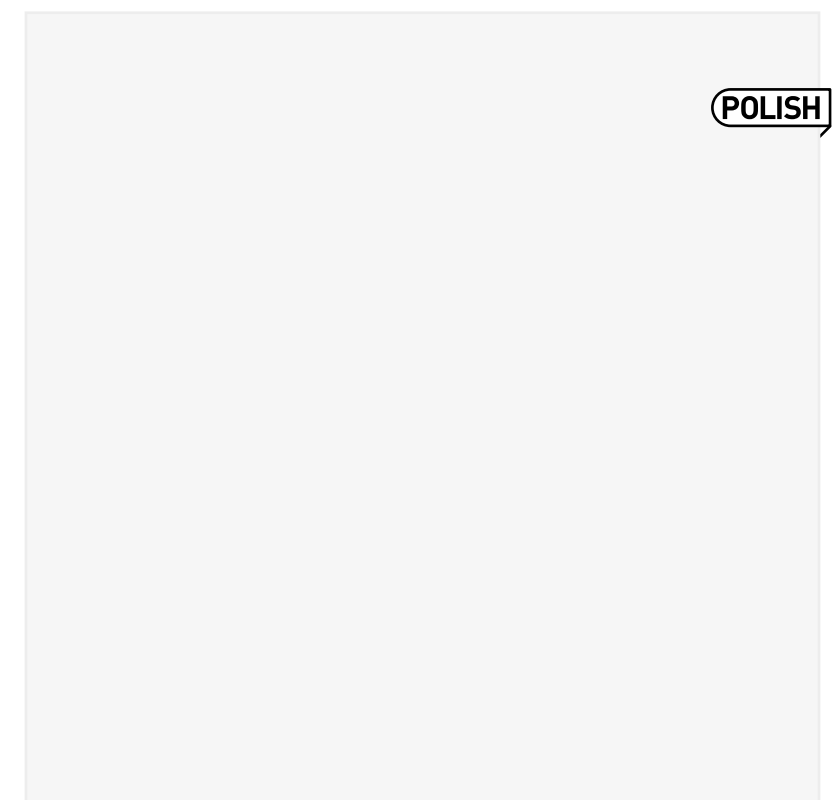

120x120 PORCELÂNICO

C40/56

Série: **Blanco Puro - Polish**

Ref.: RBP120120







PE

Porcelânico Esmaltado  
Glazed tiles, Grès cérame émaillé,  
Feinsteinzeug Glasiert, Porcelánico esmaltado

RET

Retificado  
Rectified / Rectifié / Verarbeitet / Rectificado

Pisos e Paredes  
Floor and Walls / Sols et Murs  
Wandfliesen und Bodenfliesen / Pisos y Paredes

Variação Média V1  
Average tone variation / Variation moyenne  
Durchschnittliche Tonhöhenschwankung  
Variación media de tono

Resistente ao gelo  
Frost resistant / Résistant au gel  
Frostbeständig / Resistente al hielo

Espessura  
Thickness / Épaisseur / Dicke / Grosor

Recomendamos o uso de niveladores  
Recommended levelers / craillons auto-nivellants conseillé  
Empfohlene Richtmaschinen / Niveladores recomendados

**120x120**  
2 Pcs  
2,88 m<sup>2</sup>  
60 Kg

**60x120**  
2 Pcs  
1,44 m<sup>2</sup>  
30,6 Kg

**60x60**  
4 Pcs  
1,44 m<sup>2</sup>  
28,5 Kg

**PAL**  
28 Cx  
80,64 m<sup>2</sup>  
1.695 Kg

**PAL**  
32 Cx  
46,08 m<sup>2</sup>  
1.010 Kg

**PAL**  
40 Cx  
57,60 m<sup>2</sup>  
1.155 Kg

Degraus rodapés e peças especiais  
na página 264 a 275.

## Blanco Puro Mate

MATE

60x60 PORCELÂNICO

C20/28

Série: **Blanco Puro - Mate**

Ref.: RBP6060MT



5 606779 210913

MATE

60x120 PORCELÂNICO

C32/45

Série: **Blanco Puro - Mate**

Ref.: RBP60120MT



5 606779 209535

MATE

120x120 PORCELÂNICO

C38/53

Série: **Blanco Puro - Mate**

Ref.: RBP120120MT



5 606779 214973





Vidro  
Glass / Verre / Vidrio / Glas



Retificado  
Rectified / Rectifié / Verarbeitet / Rectificado



Pisos e Paredes  
Floor and Walls / Sols et Murs  
Wandfliesen und Bodenfliesen / Pisos y Paredes



Variação Média V1  
Average tone variation / Variation moyenne  
Durchschnittliche Tonhöhen schwankung  
Variación media de tono



Resistente ao gelo  
Frost resistant / Résistant au gel  
Frostbeständig / Resistente al hielo



Espessura  
Thickness / Épaisseur / Dicke / Grosor



Recomendamos o uso de niveladores  
Recommended levelers / croisillons auto-nivellants conseillé  
Empfohlene Richtmaschinen / Niveladores recomendados

**60x120**

2 Pcs  
1,44 m<sup>2</sup>  
50 Kg

**80x80**

2 Pcs  
1,28 m<sup>2</sup>  
49 Kg

**PAL**

40 Cx  
57,60 m<sup>2</sup>  
2.000 Kg

**PAL**

28 Cx  
35,84 m<sup>2</sup>  
1.372 Kg

# Microcrystal

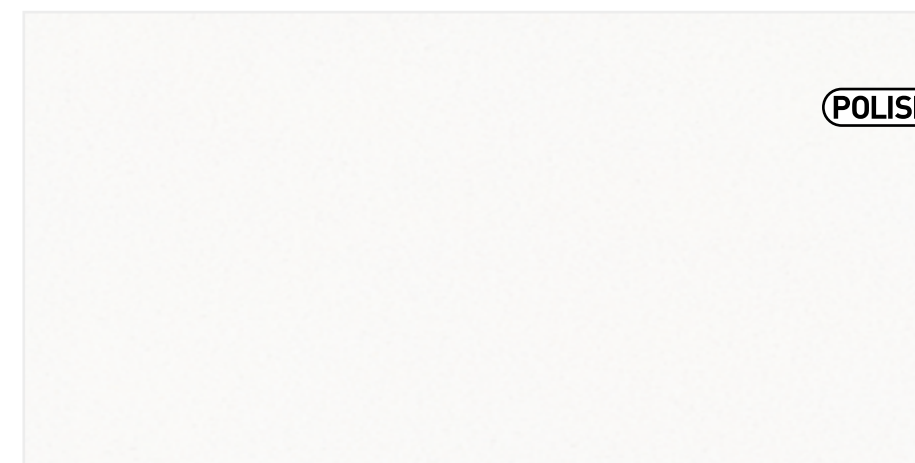

60x120

C120/168

Série: **Microcrystal Branco Gelo - Polido**

Ref.: RMC60120BG



5 606779 164469



80x80

C100/140

Série: **Microcrystal Branco Gelo Polido**

Ref.: RMC8080BG



5 606779 164483





PE

Porcelânico Esmaltado  
Glazed tiles, Grès cérame émaillé,  
Feinsteinzeug Glasiert, Porcelánico esmaltado

RET

Retificado  
Rectified / Rectifié / Verarbeitet / Rectificado



Pisos e Paredes  
Floor and Walls / Sols et Murs  
Wandfliesen und Bodenfliesen / Pisos y Paredes



Variação Média V3  
Average tone variation / Variation moyenne  
Durchschnittliche Tonhöhenschwankung  
Variación media de tono



Resistente ao gelo  
Frost resistant / Résistant au gel  
Frostbeständig / Resistente al hielo



Espessura  
Thickness / Épaisseur / Dicke / Grosor



Recomendamos o uso de niveladores  
Recommended levelers / craisillons auto-nivellants conseillé  
Empfohlene Richtmaschinen / Niveladores recomendados



**90x90**  
2 Pcs  
1,61 m<sup>2</sup>  
51,50 Kg



**PAL**  
30 Cx  
48,30 m<sup>2</sup>  
1264 Kg

Degraus rodapés e peças especiais  
na página 264 a 275.

Twist

PORCELÂNICOS



90x90 PORCELÂNICO

C35/49

Série: **Twist Ash - Polish**

Ref.: R28054E



5 606779 204868





Compacto de Quartz  
Quartz Compact / Quartz compact  
Kompakter Quarz / Cuarzo compacto



Retificado  
Rectified / Rectifié / Verarbeitet / Rectificado



Pisos e Paredes  
Floor and Walls / Sols et Murs  
Wandfliesen und Bodenfliesen / Pisos y Paredes



Variação Média V1  
Average tone variation / Variation moyenne  
Durchschnittliche Tonhöhenchwankung  
Variación media de tono



Resistente ao gelo  
Frost resistant / Résistant au gel  
Frostbeständig / Resistente al hielo



Espessura  
Thickness / Épaisseur / Dicke / Grosor



Recomendamos o uso de niveladores  
Recommended levelers / craisillons auto-nivellants conseillé  
Empfohlene Richtmaschinen / Niveladores recomendados



**PCS**  
3 Pcs  
1,08 m<sup>2</sup>  
31 Kg



**PAL**  
36 Cx  
38,88 m<sup>2</sup>  
1122 Kg

# Quartzo

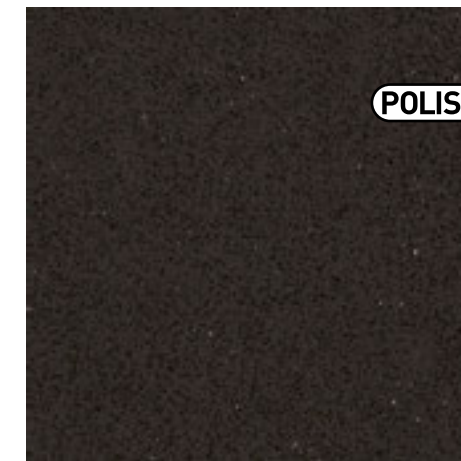

60x60 COMPACTO DE QUARTZO **C120/168**

Série: **Quartzo Preto - Polido**

Ref.: RQSJ5166060



60x60 COMPACTO DE QUARTZO **C120/168**

Série: **Quartzo Cinza - Polido**

Ref.: RQSJ5136060



60x60 COMPACTO DE QUARTZO **C120/168**

Série: **Quartzo Branco - Polido**

Ref.: RQSJ5116060







\* Super Black só para uso Residencial



Porcelânico Tudo Massa  
Full Body / Pleine Masse  
Ganzkörper / Todo masa



Retificado  
Rectified / Rectifié / Verarbeitet / Rectificado



Pisos e Paredes  
Floor and Walls / Sols et Murs  
Wandfliesen und Bodenfliesen / Pisos y Paredes



Variação Média V1  
Average tone variation / Variation moyenne  
Durchschnittliche Tonhöhen schwankung  
Variación media de tono



Resistente ao gelo  
Frost resistant / Résistant au gel  
Frostbeständig / Resistente al hielo



Espessura  
Thickness / Épaisseur / Dicke / Grosor



Recomendamos o uso de niveladores  
Recommended levelers / craisillons auto-nivellants conseillé  
Empfohlene Richtmaschinen / Niveladores recomendados



PCS  
4 Pcs  
1,44 m<sup>2</sup>  
31 Kg



PAL  
40 Cx  
57,60 m<sup>2</sup>  
1240 Kg

Degraus rodapés e peças especiais  
na página 255 e 256.

# Super

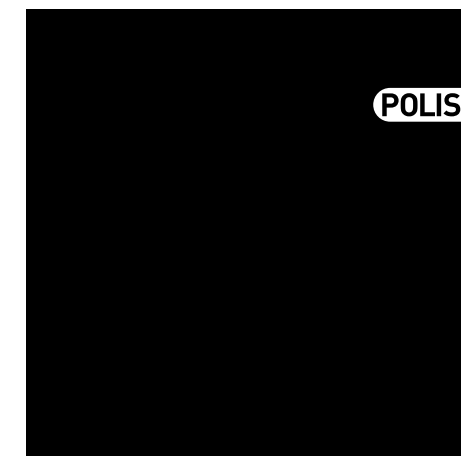

60x60 PORCELÂNICO FULL BODY

C55/77

Série: **Super Black - Polido**

Ref.: RJB607



5 606779 161123

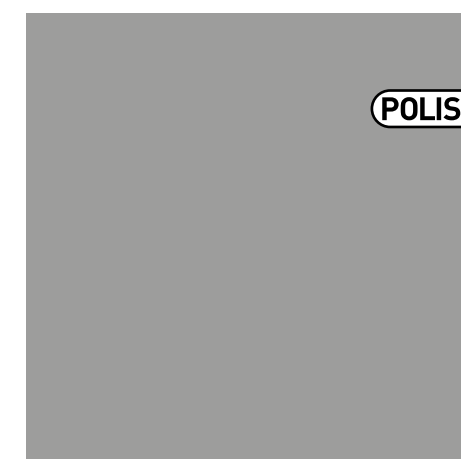

60x60 PORCELÂNICO FULL BODY

C35/49

Série: **Super Grey - Polido**

Ref.: RSP6002T



5 606779 171702



60x60 PORCELÂNICO FULL BODY

C30/42

Série: **Super White - Polido**

Ref.: RKAJ600



5 606779 161529





Porcelânico Esmaltado  
Glazed tiles, Grès cérame émaillé,  
Feinsteinzeug Glasiert, Porcelánico esmaltado



Retificado  
Rectified / Rectifié / Verarbeitet / Rectificado



Pisos e Paredes  
Floor and Walls / Sols et Murs  
Wandfliesen und Bodenfliesen / Pisos y Paredes



Variação Média V3  
Average tone variation / Variation moyenne  
Durchschnittliche Tonhöhen schwankung  
Variación media de tono



Resistente ao gelo  
Frost resistant / Résistant au gel  
Frostbeständig / Resistente al hielo



Espessura  
Thickness / Épaisseur / Dicke / Grosor



Recomendamos o uso de niveladores  
Recommended levelers / craisillons auto-nivellants conseillé  
Empfohlene Richtmaschinen / Niveladores recomendados



**60x120**  
2 Pcs  
1,44 m<sup>2</sup>  
30,6 Kg



**120x120**  
2 Pcs  
2,88 m<sup>2</sup>  
62 Kg



**90x90**  
2 Pcs  
1,61 m<sup>2</sup>  
51,50 Kg



**PAL**  
32 Cx  
46,08 m<sup>2</sup>  
1.010 Kg



**PAL**  
24 Cx  
69,12 m<sup>2</sup>  
1.500 Kg



**PAL**  
30 Cx  
48,30 m<sup>2</sup>  
1.264 Kg

Degraus rodapés e peças especiais  
na página 264 a 275.

## Travertino Navona Bianco



60x120 PORCELÂNICO

**C26/37**

Série: **Travertino Navona Bianco - Mate**

Ref.: RTN60120B



5 606779 181978

60x120 PORCELÂNICO

**C30/42**

Série: **Travertino Navona Bianco - Polido**

Ref.: RTN60120PB



5 606779 173706

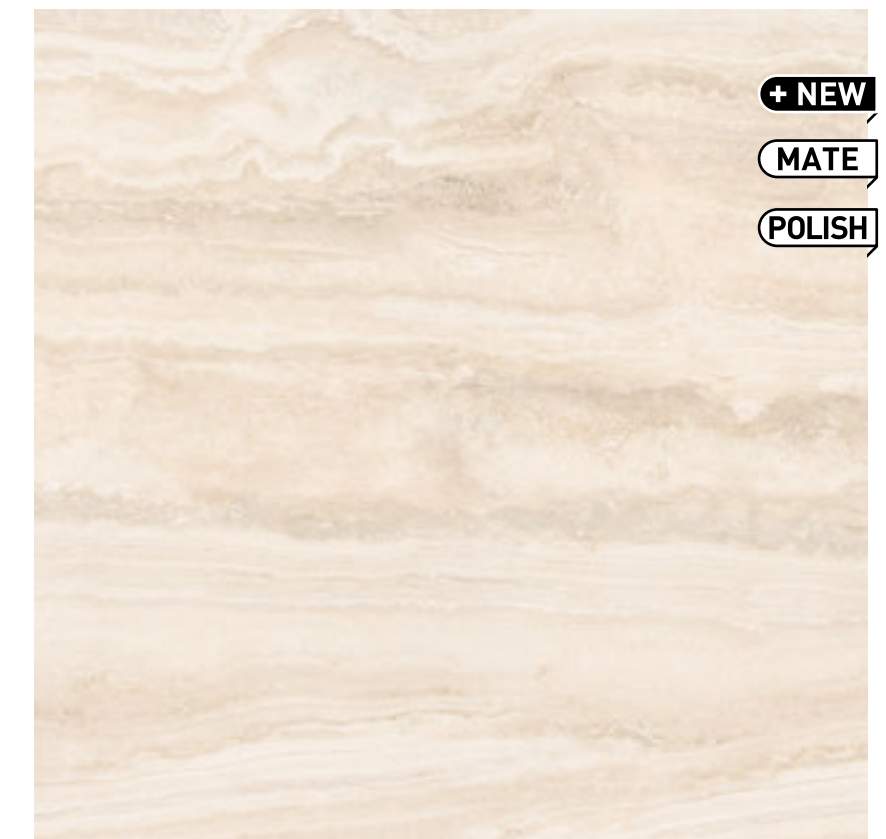

120x120 PORCELÂNICO

**C36/50**

Série: **Travertino Navona Bianco - Mate**

Ref.: RTNB120120MT



5 606779 251046

120x120 PORCELÂNICO

**C40/56**

Série: **Travertino Navona Bianco - Polido**

Ref.: RTN120120PB



5 606779 251039

90x90 PORCELÂNICO

**C36/50**

Série: **Travertino Navona Bianco - Natural**

Ref.: RTN9090B



5 606779 173744





PE

Porcelânico Esmaltado  
Glazed tiles, Grès cérame émaillé,  
Feinsteinzeug Glasiert, Porcelánico esmaltado

RET

Retificado  
Rectified / Rectifié / Verarbeitet / Rectificado



Pisos e Paredes  
Floor and Walls / Sols et Murs  
Wandfliesen und Bodenfliesen / Pisos y Paredes



Variação Média V3  
Average tone variation / Variation moyenne  
Durchschnittliche Tonhöhen schwankung  
Variación media de tono



Resistente ao gelo  
Frost resistant / Résistant au gel  
Frostbeständig / Resistente al hielo



Espessura  
Thickness / Épaisseur / Dicke / Grosor



Recomendamos o uso de niveladores  
Recommended levelers / craisillons auto-nivellants conseillé  
Empfohlene Richtmaschinen / Niveladores recomendados

120x120

2 Pcs  
2,88 m<sup>2</sup>  
60 Kg

PAL

28 Cx  
80,64 m<sup>2</sup>  
1.695 Kg

Degraus rodapés e peças especiais  
na página 264 a 275.

# Marmy S. Laurent Noir

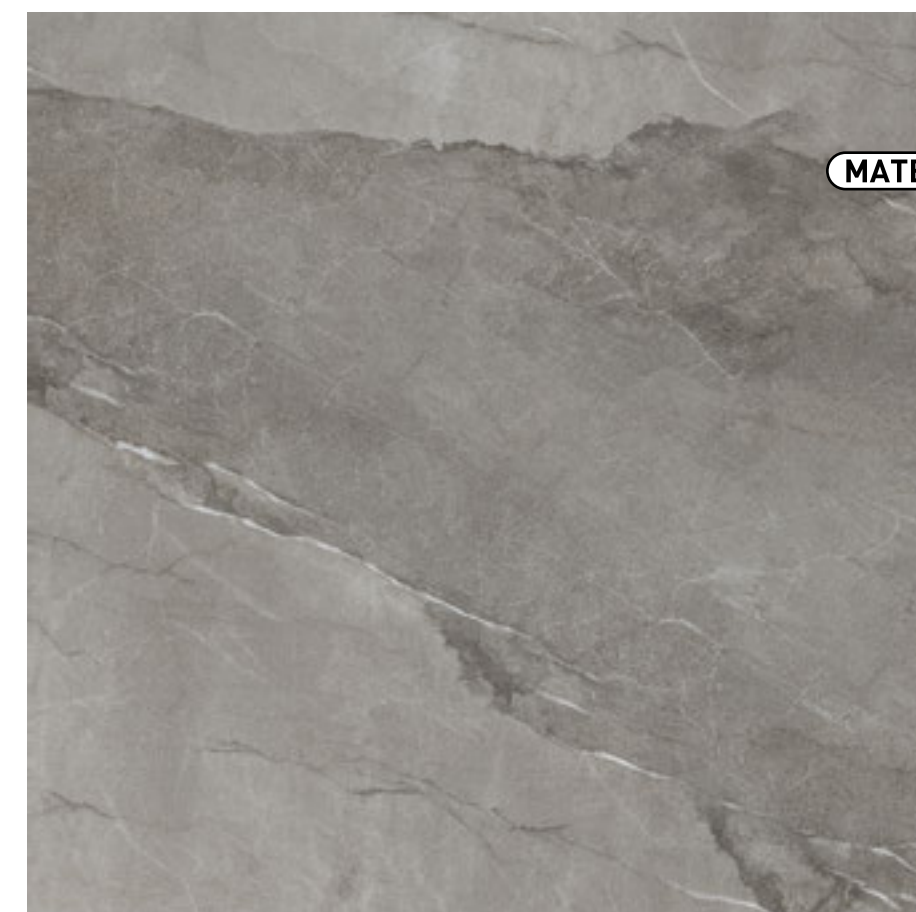

120x120 PORCELÂNICO

C36/50

Série: **Marmy S. Laurent Noir - Mate**

Ref.: RM120120SLNM



5 606779 215888





PE

Porcelânico Esmaltado  
Glazed tiles, Grès cérame émaillé,  
Feinsteinzeug Glasiert, Porcelánico esmaltado

RET

Retificado  
Rectified / Rectifié / Verarbeitet / Rectificado



Pisos e Paredes  
Floor and Walls / Sols et Murs  
Wandfliesen und Bodenfliesen / Pisos y Paredes



Variação Média V3  
Average tone variation / Variation moyenne  
Durchschnittliche Tonhöhenchwankung  
Variación media de tono



Resistente ao gelo  
Frost resistant / Résistant au gel  
Frostbeständig / Resistente al hielo



Espessura  
Thickness / Épaisseur / Dicke / Grosor



Recomendamos o uso de niveladores  
Recommended levelers / craisillons auto-nivellants conseillé  
Empfohlene Richtmaschinen / Niveladores recomendados

PCS

1 Pcs  
1,43 m<sup>2</sup>  
31,5 Kg

PAL

42 Cx  
60,06 m<sup>2</sup>  
1.322 Kg

Degraus rodapés e peças especiais  
na página 264 a 275.

# Gray Marble



120x120 PORCELÂNICO

C40/56

Série: **Gray Marble - Mate**

Ref.: RGM120120GRMNAT



5 606779 251190



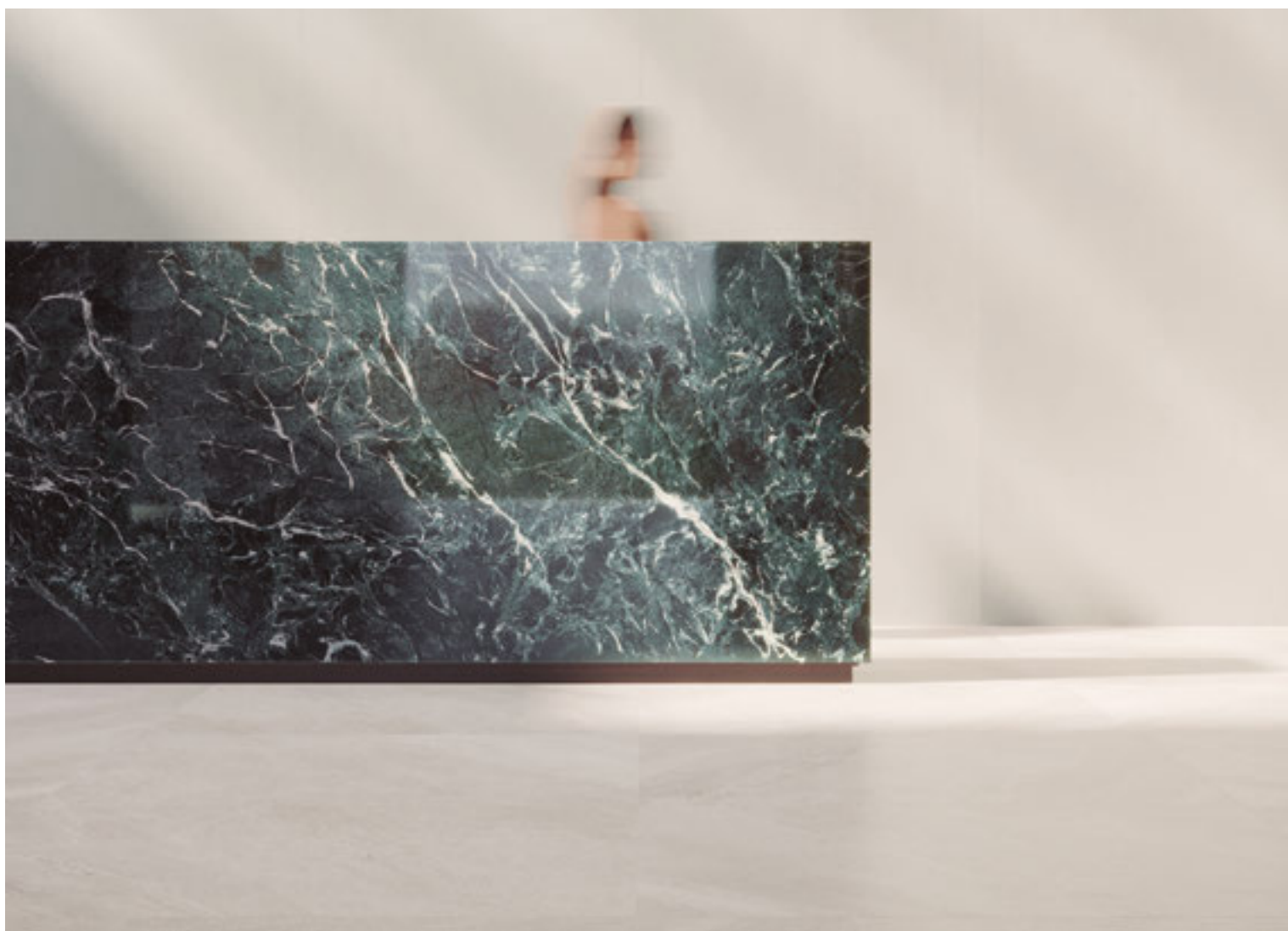

Porcelânico Esmaltado  
Glazed tiles, Grès cérame émaillé,  
Feinsteinzeug Glasiert, Porcelánico esmaltado



Retificado  
Rectified / Rectifié / Verarbeitet / Rectificado



Pisos e Paredes  
Floor and Walls / Sols et Murs  
Wandfliesen und Bodenfliesen / Pisos y Paredes



Variação Média V3  
Average tone variation / Variation moyenne  
Durchschnittliche Tonhöhenchwankung  
Variación media de tono



Resistente ao gelo  
Frost resistant / Résistant au gel  
Frostbeständig / Resistente al hielo



Espessura  
Thickness / Épaisseur / Dicke / Grosor



Recomendamos o uso de niveladores  
Recommended levelers / craillons auto-nivellants conseillé  
Empfohlene Richtmaschinen / Niveladores recomendados



1 Pcs  
1,43 m<sup>2</sup>  
31,5 Kg



42 Cx  
60,06 m<sup>2</sup>  
1.322 Kg

Degraus rodapés e peças especiais  
na página 264 a 275.

# Oh!Take Mountain



120x120 PORCELÂNICO

C40/56

Série: **Oh!Take Mountain - Mate**

Ref.: ROH120120MONAT



HOME  
ROH120120HOMNAT



CLIF  
ROH120120CLINAT



CITY  
ROH120120CTYNAT



MOON  
ROH120120MONNAT



FOREST  
ROH120120FORNAT



HEAVEN  
ROH120120HEANAT





Porcelânico Esmaltado  
Glazed tiles / Grès cérame émaillé,  
Feinsteinzeug Glasiert, Porcelánico esmaltado



Retificado  
Rectified / Rectifié / Verarbeitet / Rectificado



Pisos e Paredes  
Floor and Walls / Sols et Murs  
Wandfliesen und Bodenfliesen / Pisos y Paredes



Variação Média V3  
Average tone variation / Variation moyenne  
Durchschnittliche Tonhöhenchwankung  
Variación media de tono



Resistente ao gelo  
Frost resistant / Résistant au gel  
Frostbeständig / Resistente al hielo



Espessura  
Thickness / Épaisseur / Dicke / Grosor



Recomendamos o uso de niveladores  
Recommended levels / craisillons auto-nivellants conseillé  
Empfohlene Richtmaschinen / Niveladores recomendados



2 Pcs  
2,88 m<sup>2</sup>  
62 Kg



24 Cx  
69,12 m<sup>2</sup>  
1500 Kg

Degraus rodapés e peças especiais  
na página 264 a 275.

# Glacier

PORCELÂNICOS



+ NEW

MATE

120x120 PORCELÂNICO

C40/56

Série: **Glacier - Mate**

Ref.: RST120120GLAM



5 606779 229816



+ NEW

MATE

120x120 PORCELÂNICO

C40/56

Série: **Glacier Storm - Mate**

Ref.: RST120120STOM



5 606779 229816



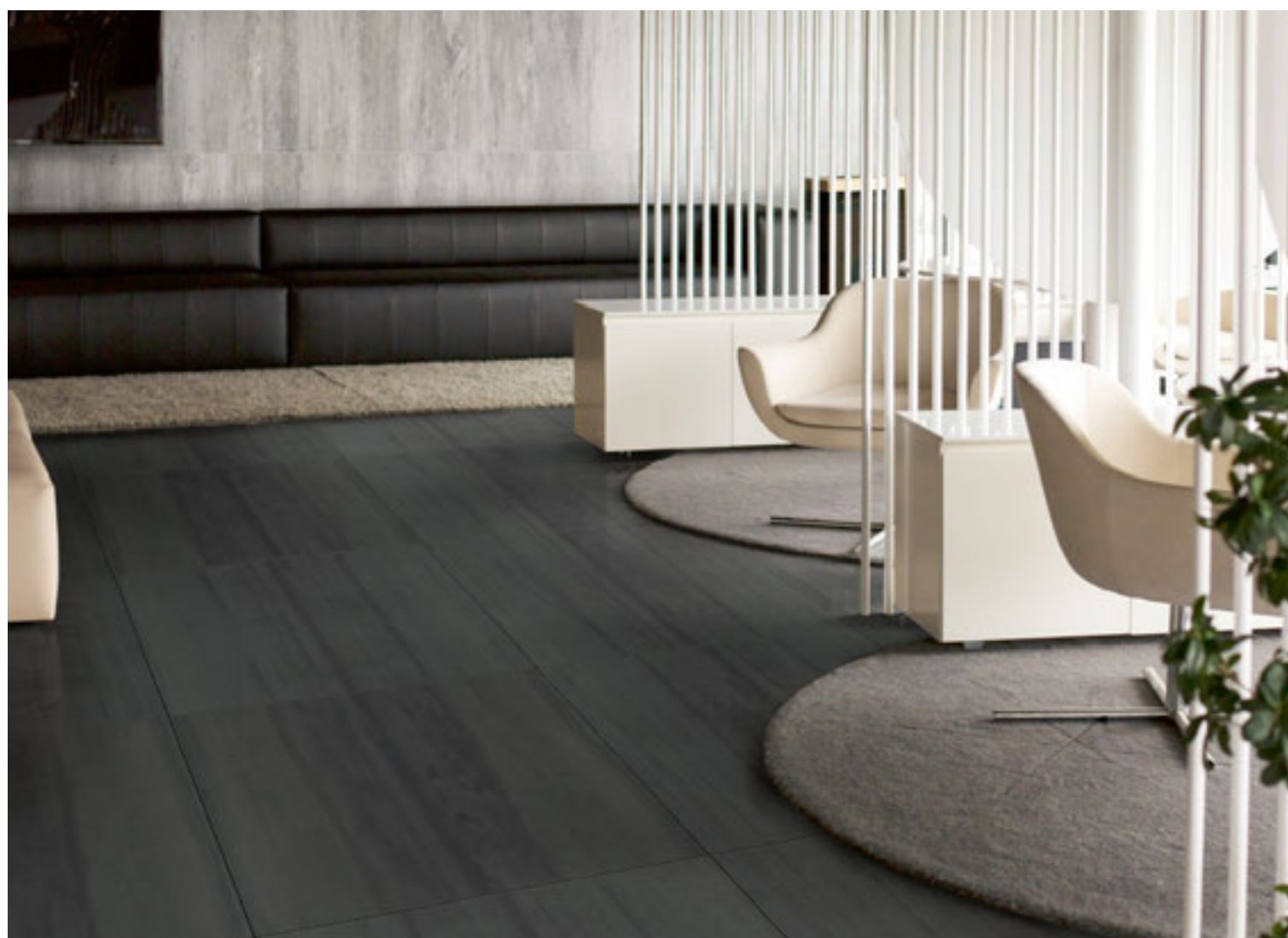

PE

Porcelânico Esmaltado  
Glazed tiles, Grès cérame émaillé,  
Feinsteinzeug Glasiert, Porcelánico esmaltado

RET

Retificado  
Rectified / Rectifié / Verarbeitet / Rectificado



Pisos e Paredes  
Floor and Walls / Sols et Murs  
Wandfliesen und Bodenfliesen / Pisos y Paredes



Variação Média V3  
Average tone variation / Variation moyenne  
Durchschnittliche Tonhöhenchwankung  
Variación media de tono



Resistente ao gelo  
Frost resistant / Résistant au gel  
Frostbeständig / Resistente al hielo



Espessura  
Thickness / Épaisseur / Dicke / Grosor



Recomendamos o uso de niveladores  
Recommended levelers / craisillons auto-nivellants conseillé  
Empfohlene Richtmaschinen / Niveladores recomendados



PCS

2 Pcs  
2,88 m<sup>2</sup>  
80 Kg



PAL

20 Cx  
57,60 m<sup>2</sup>  
1.610 Kg

Degraus rodapés e peças especiais  
na página 264 a 275.

# Himalaya & Lanzarote

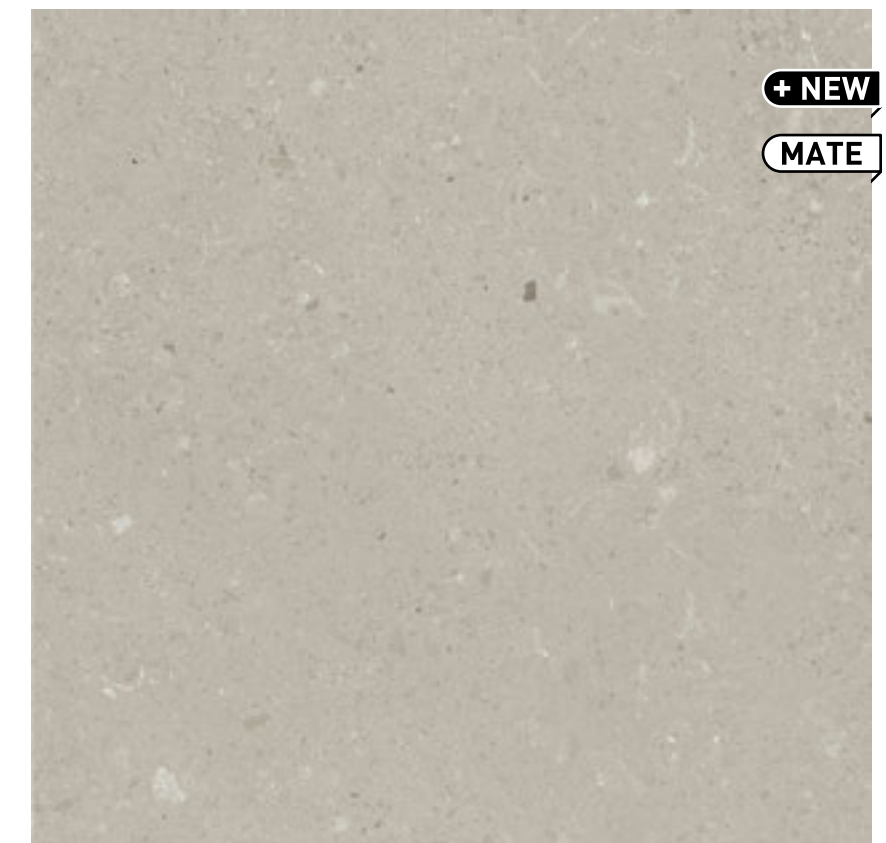

+ NEW

MATE

120x120 PORCELÂNICO

C36/50

Série: **Himalaya - Mate**

Ref.: RH1120120HIM



5 606779 229960



+ NEW

MATE

120x120 PORCELÂNICO

C36/50

Série: **Lanzarote - Mate**

Ref.: RLA120120LAM



5 606779 229977





**R11**

Resistência ao Deslizamento  
Slip resistance, Résistance à la glissance,  
Rutschkoeffizient, Resistencia al deslizamiento

**PE**

Porcelânico Esmaltado  
Glazed tiles, Grès cérame émaillé,  
Feinsteinzeug Glasiert, Porcelânico esmaltado

**RET**

Retificado  
Rectified / Rectifié / Verarbeitet / Rectificado

Pisos e Paredes  
Floor and Walls / Sols et Murs  
Wandfliesen und Bodenfliesen / Pisos y Paredes

Variação Média V3  
Average tone variation / Variation moyenne  
Durchschnittliche Tonhöhenchwankung  
Variación media de tono

Resistente ao gelo  
Frost resistant / Résistant au gel  
Frostbeständig / Resistente al hielo

Espessura  
Thickness / Épaisseur / Dicke / Grosor

Recomendamos o uso de niveladores  
Recommended levelers / craisillons auto-nivellants conseillé  
Empfohlene Richtmaschinen / Niveladores recomendados

**PCS**

1 Pcs  
1,43 m<sup>2</sup>  
31,5 Kg

**PAL**

42 Cx  
60,06 m<sup>2</sup>  
1.322 Kg

Degraus rodapés e peças especiais  
na página 264 a 275.

# Posto 10

PORCELÂNICOS

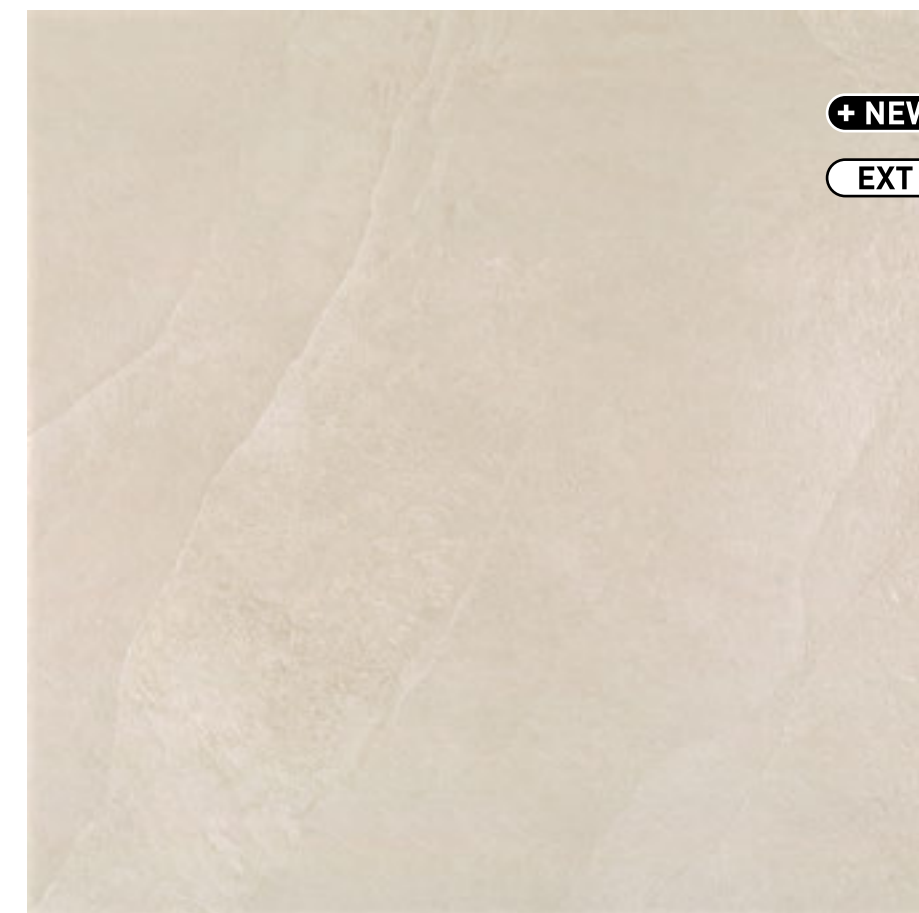

**+ NEW**

**EXT**

ANTI SLIP FLOOR

**120x120 PORCELÂNICO**

**C40/56**

Série: **Posto 10 - EXT antislip**

Ref.: **RP120120PO10EXT**



5 606779 251206





Porcelânico Esmaltado  
Glazed tiles, Grès cérame émaillé,  
Feinsteinzeug Glasiert, Porcelánico esmaltado



Retificado  
Rectified / Rectifié / Verarbeitet / Rectificado



Pisos e Paredes  
Floor and Walls / Sols et Murs  
Wandfliesen und Bodenfliesen / Pisos y Paredes



Variação Média V3  
Average tone variation / Variation moyenne  
Durchschnittliche Tonhöhenchwankung  
Variación media de tono



Resistente ao gelo  
Frost resistant / Résistant au gel  
Frostbeständig / Resistente al hielo



Espessura  
Thickness / Épaisseur / Dicke / Grosor



Recomendamos o uso de niveladores  
Recommended levelers / craisillons auto-nivellants conseillé  
Empfohlene Richtmaschinen / Niveladores recomendados



PCS  
2 Pcs  
2,88 m<sup>2</sup>  
80 Kg



PAL  
20 Cx  
57,60 m<sup>2</sup>  
1.610 Kg

Degraus rodapés e peças especiais  
na página 264 a 275.

# Ural Dark

PORCELÂNICOS



+ NEW

MATE

EXT

120x120 PORCELÂNICO

C36/50

Série: **Ural Dark - Mate**

Ref.: RUR120120UDK



5 606779 229953



120x120 PORCELÂNICO - R11

C36/50

Série: **Ural Dark - EXT antislip**

Ref.: RUR120120UDKEXT



5 606779 229946





Porcelânico Esmaltado  
Glazed tiles, Grès cérame émaillé,  
Feinsteinzeug Glasiert, Porcelánico esmaltado



Retificado  
Rectified / Rectifié / Verarbeitet / Rectificado



Pisos e Paredes  
Floor and Walls / Sols et Murs  
Wandfliesen und Bodenfliesen / Pisos y Paredes



Variação Média V3  
Average tone variation / Variation moyenne  
Durchschnittliche Tonhöhen schwankung  
Variación media de tono



Resistente ao gelo  
Frost resistant / Résistant au gel  
Frostbeständig / Resistente al hielo



Espessura  
Thickness / Épaisseur / Dicke / Grosor



Recomendamos o uso de niveladores  
Recommended levelers / craisillons auto-nivellants conseillé  
Empfohlene Richtmaschinen / Niveladores recomendados



**PCS**  
**60x120**  
2 Pcs  
1,44 m<sup>2</sup>  
31 Kg



**PCS**  
**120x120**  
2 Pcs  
2,88 m<sup>2</sup>  
60 Kg



**PAL**  
32 Cx  
46,08 m<sup>2</sup>  
1.010 Kg



**PAL**  
28 Cx  
80,64 m<sup>2</sup>  
1.680 Kg

Degraus rodapés e peças especiais  
na página 264 a 275.

# Beton Ivory



**+ NEW**

**MATE**

**60x120 PORCELÂNICO**

**C26/37**

Série: **Beton Ivory - Mate**

Ref.: RBE60120IVM



5 606779 229588



**+ NEW**

**MATE**

**120x120 PORCELÂNICO**

**C36/50**

Série: **Beton Ivory - Mate**

Ref.: RBE120120IVOM



5 606779 252821





Porcelânico Esmaltado  
Glazed tiles / Grès cérame émaillé,  
Feinsteinzeug Glasiert, Porcelánico esmaltado



Retificado  
Rectified / Rectifié / Verarbeitet / Rectificado



Pisos e Paredes  
Floor and Walls / Sols et Murs  
Wandfliesen und Bodenfliesen / Pisos y Paredes



Variação Média V3  
Average tone variation / Variation moyenne  
Durchschnittliche Tonhöhenchwankung  
Variación media de tono



Resistente ao gelo  
Frost resistant / Résistant au gel  
Frostbeständig / Resistente al hielo



Espessura  
Thickness / Épaisseur / Dicke / Grosor

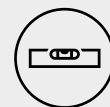

Recomendamos o uso de niveladores  
Recommended levelers / craisillons auto-nivellants conseillé  
Empfohlene Richtmaschinen / Niveladores recomendados



**PCS**  
**60x120**  
2 Pcs  
1,44 m<sup>2</sup>  
31 Kg



**PCS**  
**120x120**  
2 Pcs  
2,88 m<sup>2</sup>  
60 Kg



**PAL**  
32 Cx  
46,08 m<sup>2</sup>  
1.010 Kg



**PAL**  
28 Cx  
80,64 m<sup>2</sup>  
1.680 Kg

Degraus rodapés e peças especiais  
na página 264 a 275.

## Beton Cemento



+ NEW

MATE

60x120 PORCELÂNICO

C26/37

Série: **Beton Cemento - Mate**

Ref.: RBE60120CEM



5 606779 229588



+ NEW

MATE

120x120 PORCELÂNICO

C36/50

Série: **Beton Cemento - Mate**

Ref.: RBE120120CEM



5 606779 229199





Porcelânico Esmaltado  
Glazed tiles, Grès cérame émaillé,  
Feinsteinzeug Glasiert, Porcelánico esmaltado



Retificado  
Rectified / Rectifié / Verarbeitet / Rectificado



Pisos e Paredes  
Floor and Walls / Sols et Murs  
Wandfliesen und Bodenfliesen / Pisos y Paredes



Variação Média V3  
Average tone variation / Variation moyenne  
Durchschnittliche Tonhöhenchwankung  
Variación media de tono



Resistente ao gelo  
Frost resistant / Résistant au gel  
Frostbeständig / Resistente al hielo



Espessura  
Thickness / Épaisseur / Dicke / Grosor



Recomendamos o uso de niveladores  
Recommended levelers / craisillons auto-nivellants conseillé  
Empfohlene Richtmaschinen / Niveladores recomendados



**PCS**  
**60x120**  
2 Pcs  
1,44 m<sup>2</sup>  
31 Kg



**PCS**  
**120x120**  
2 Pcs  
2,88 m<sup>2</sup>  
60 Kg



**PAL**  
32 Cx  
46,08 m<sup>2</sup>  
1.010 Kg



**PAL**  
28 Cx  
80,64 m<sup>2</sup>  
1.680 Kg

Degraus rodapés e peças especiais  
na página 264 a 275.

# Beton Gris



**+ NEW**

**MATE**

**60x120 PORCELÂNICO**

**C26/37**

Série: **Beton Gris - Mate**

Ref.: RBE60120GRIM



5 606779 229571

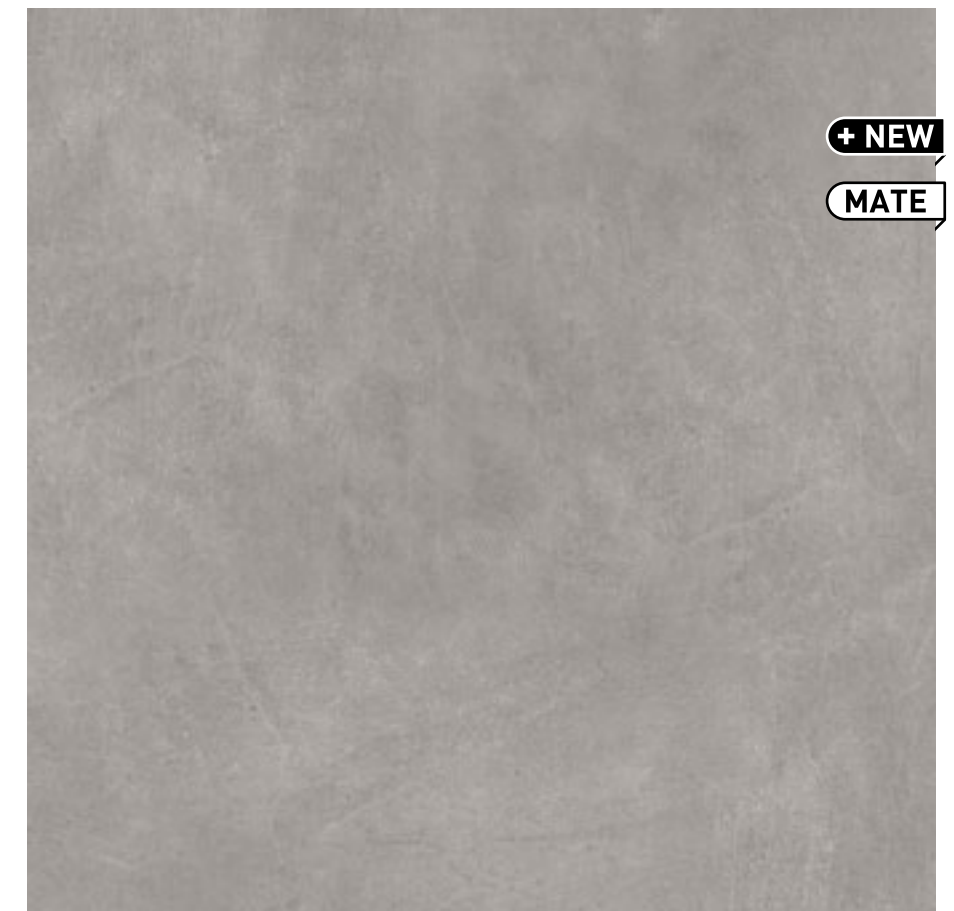

**+ NEW**

**MATE**

**120x120 PORCELÂNICO**

**C36/50**

Série: **Beton Gris - Mate**

Ref.: RBE120120GRIM



5 606779 229205





Porcelânico Esmaltado  
Glazed tiles, Grès cérame émaillé,  
Feinsteinzeug Glasiert, Porcelánico esmaltado



Retificado  
Rectified / Rectifié / Verarbeitet / Rectificado



Pisos e Paredes  
Floor and Walls / Sols et Murs  
Wandfliesen und Bodenfliesen / Pisos y Paredes



Variação Média V3  
Average tone variation / Variation moyenne  
Durchschnittliche Tonhöhenchwankung  
Variación media de tono



Resistente ao gelo  
Frost resistant / Résistant au gel  
Frostbeständig / Resistente al hielo



Espessura  
Thickness / Épaisseur / Dicke / Grosor



Recomendamos o uso de niveladores  
Recommended levelers / craisillons auto-nivellants conseillé  
Empfohlene Richtmaschinen / Niveladores recomendados



**PCS**  
**60x120**  
2 Pcs  
1,44 m<sup>2</sup>  
31 Kg



**PCS**  
**120x120**  
2 Pcs  
2,88 m<sup>2</sup>  
60 Kg



**PAL**  
32 Cx  
46,08 m<sup>2</sup>  
1.010 Kg



**PAL**  
28 Cx  
80,64 m<sup>2</sup>  
1.680 Kg

Degraus rodapés e peças especiais  
na página 264 a 275.

# Beton Carbon



**+ NEW**

**MATE**

**60x120 PORCELÂNICO**

**C26/37**

Série: **Beton Carbon - Mate**

Ref.: RBE60120CARM



5 606779 229557



**+ NEW**

**MATE**

**120x120 PORCELÂNICO**

**C36/50**

Série: **Beton Carbon - Mate**

Ref.: RBE120120CARM



5 606779 229212





Porcelânico Esmaltado  
Glazed tiles, Grès cérame émaillé,  
Feinsteinzeug Glasiert, Porcelánico esmaltado



Retificado  
Rectified / Rectifié / Verarbeitet / Rectificado



Pisos e Paredes  
Floor and Walls / Sols et Murs  
Wandfliesen und Bodenfliesen / Pisos y Paredes



Variação Média V3  
Average tone variation / Variation moyenne  
Durchschnittliche Tonhöhenchwankung  
Variación media de tono



Resistente ao gelo  
Frost resistant / Résistant au gel  
Frostbeständig / Resistente al hielo



Espessura  
Thickness / Épaisseur / Dicke / Grosor

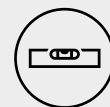

Recomendamos o uso de niveladores  
Recommended levelers / craisillons auto-nivellants conseillé  
Empfohlene Richtmaschinen / Niveladores recomendados



**PCS**  
**60x120**  
2 Pcs  
1,44 m<sup>2</sup>  
31 Kg



**PCS**  
**120x120**  
2 Pcs  
2,88 m<sup>2</sup>  
60 Kg



**PAL**  
32 Cx  
46,08 m<sup>2</sup>  
1.010 Kg



**PAL**  
28 Cx  
80,64 m<sup>2</sup>  
1.680 Kg

Degraus rodapés e peças especiais  
na página 264 a 275.

## Beton Nero

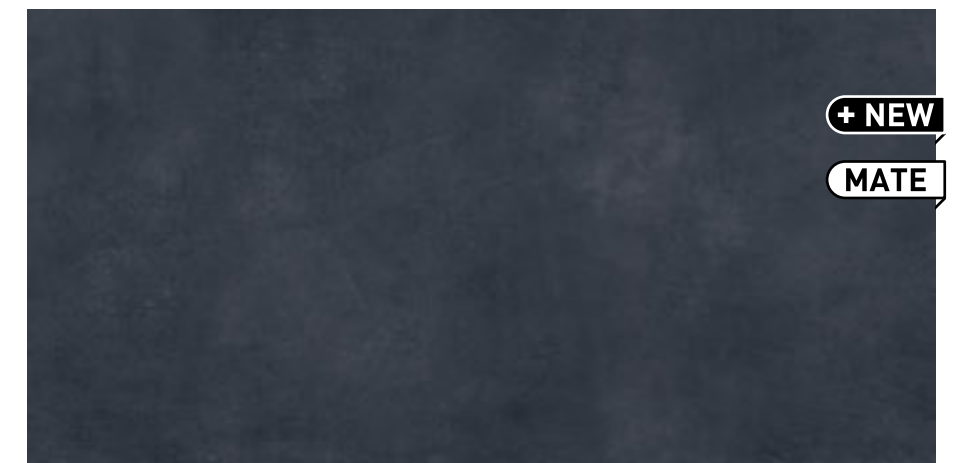

+ NEW

MATE

60x120 PORCELÂNICO

C26/37

Série: **Beton Nero - Mate**

Ref.: RBE60120NRM



5 606779 229564

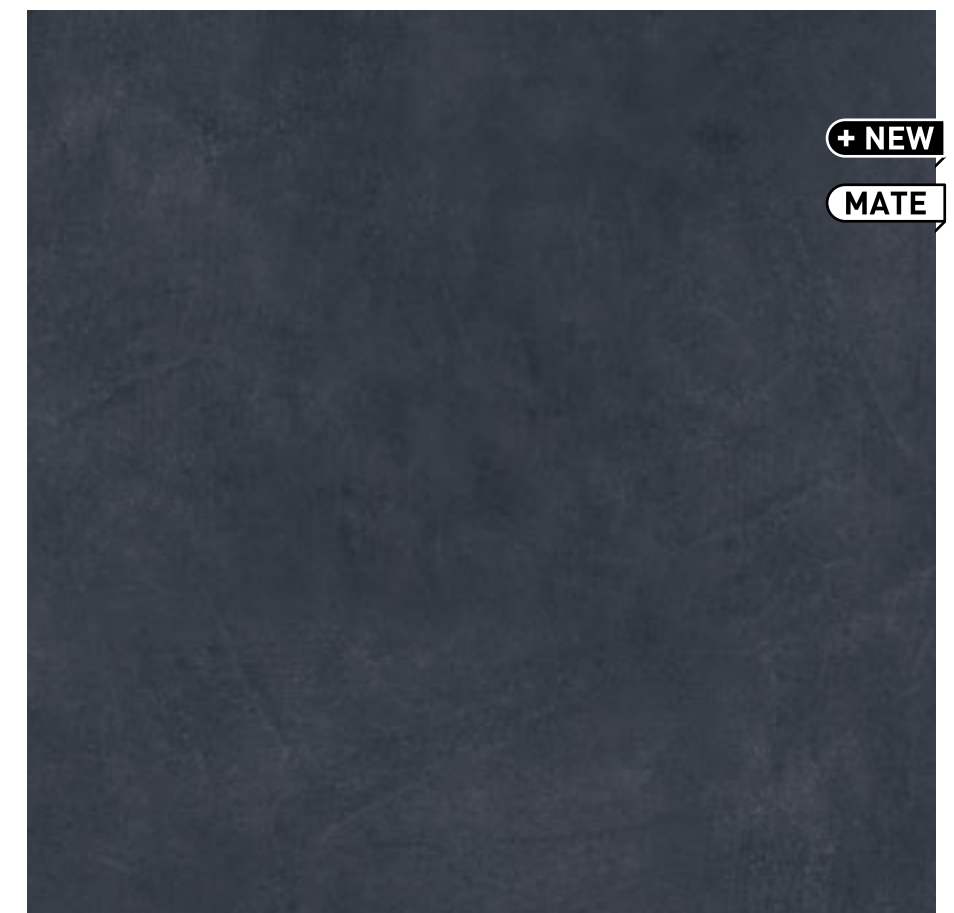

+ NEW

MATE

120x120 PORCELÂNICO

C36/50

Série: **Beton Nero - Mate**

Ref.: RBE120120NRM



5 606779 229182





Porcelânico Esmaltado  
Glazed tiles, Grès cérame émaillé,  
Feinsteinzeug Glasiert, Porcelânico esmaltado



Retificado  
Rectified / Rectifié / Verarbeitet / Rectificado



Pisos e Paredes  
Floor and Walls / Sols et Murs  
Wandfliesen und Bodenfliesen / Pisos y Paredes



Variação Média V3  
Average tone variation / Variation moyenne  
Durchschnittliche Tonhöhen schwankung  
Variación media de tono



Resistente ao gelo  
Frost resistant / Résistant au gel  
Frostbeständig / Resistente al hielo



Espessura  
Thickness / Épaisseur / Dicke / Grosor



Recomendamos o uso de niveladores  
Recommended levelers / craisillons auto-nivellants conseillé  
Empfohlene Richtmaschinen / Niveladores recomendados



**120x120**  
2 Pcs  
2,88 m<sup>2</sup>  
60 Kg



**60x60**  
4 Pcs  
1,44 m<sup>2</sup>  
28,5 Kg



**PAL**  
28 Cx  
80,64 m<sup>2</sup>  
1.695 Kg



**PAL**  
40 Cx  
57,60 m<sup>2</sup>  
1.155 Kg

Degraus rodapés e peças especiais  
na página 264 a 275.

# Hangar

PORCELÂNICOS

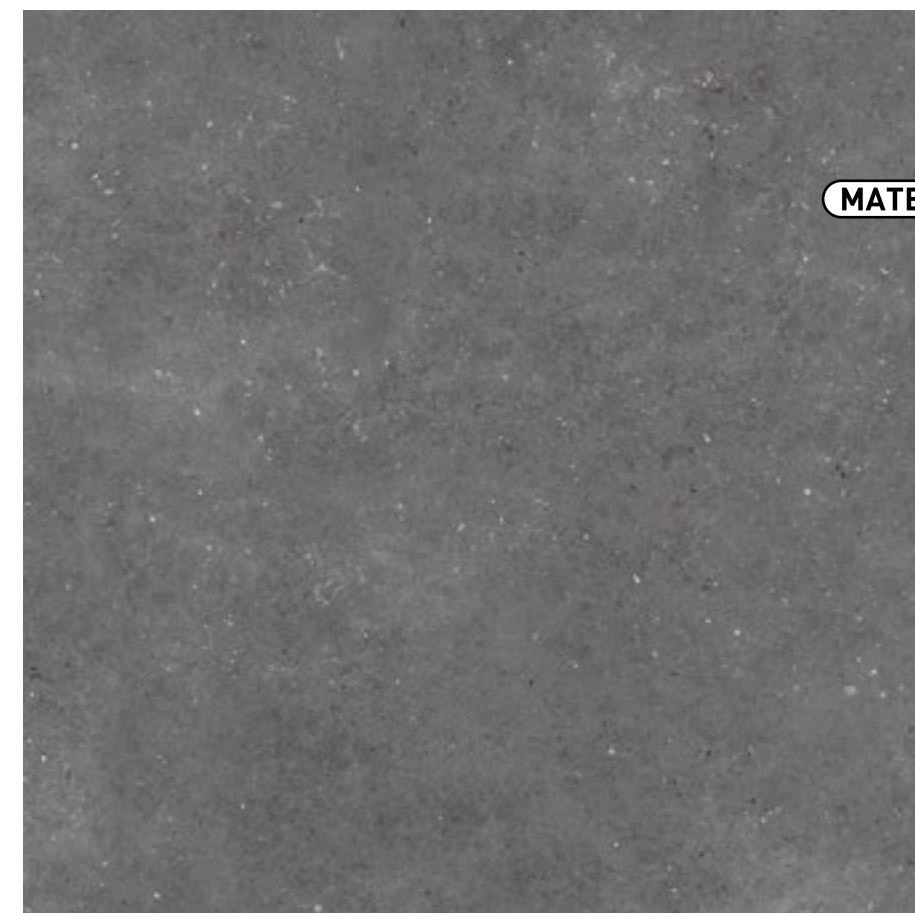

MATE

**120x120 PORCELÂNICO**

**C36/50**

Série: **Hangar Cast Iron - Natural**

Ref.: RHA120120CIM



5 606779 216069

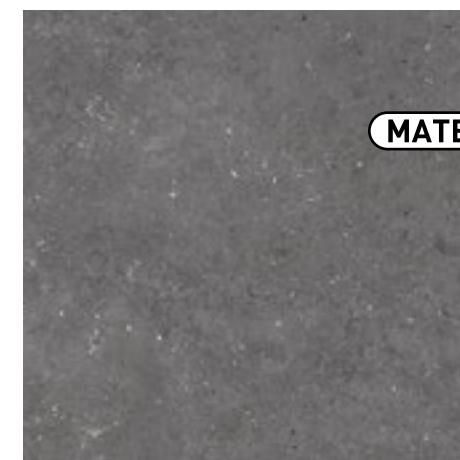

MATE

**60x60 PORCELÂNICO**

**C20/28**

Série: **Hangar Cast Iron - Natural**

Ref.: RHA6060CIM



5 606779 208750





Porcelânico Esmaltado  
Glazed tiles / Grès cérame émaillé,  
Feinsteinzeug Glasiert, Porcelânico esmaltado



Retificado  
Rectified / Rectifié / Verarbeitet / Rectificado



Pisos e Paredes  
Floor and Walls / Sols et Murs  
Wandfliesen und Bodenfliesen / Pisos y Paredes



Variação Média V3  
Average tone variation / Variation moyenne  
Durchschnittliche Tonhöhenchwankung  
Variación media de tono



Resistente ao gelo  
Frost resistant / Résistant au gel  
Frostbeständig / Resistente al hielo



Espessura  
Thickness / Épaisseur / Dicke / Grosor



Recomendamos o uso de niveladores  
Recommended levelers / craillons auto-nivellants conseillé  
Empfohlene Richtmaschinen / Niveladores recomendados



**120x120**  
2 Pcs  
2,88 m<sup>2</sup>  
60 Kg



**60x60**  
4 Pcs  
1,44 m<sup>2</sup>  
28,5 Kg



**PAL**  
28 Cx  
80,64 m<sup>2</sup>  
1.695 Kg



**PAL**  
40 Cx  
57,60 m<sup>2</sup>  
1.155 Kg

Degraus rodapés e peças especiais  
na página 264 a 275.

# Officina

PORCELÂNICOS

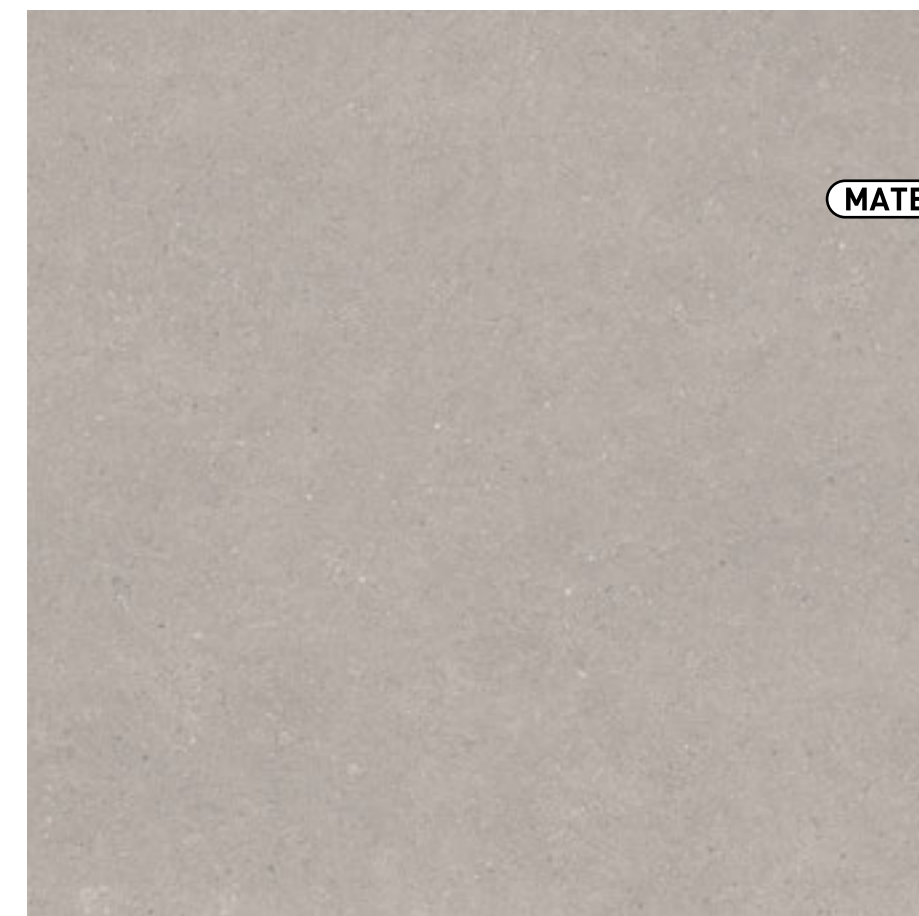

**120x120 PORCELÂNICO**

**C36/50**

Série: **Officina Cloud - Natural**

Ref.: ROF120120CLM



5 606779 216052

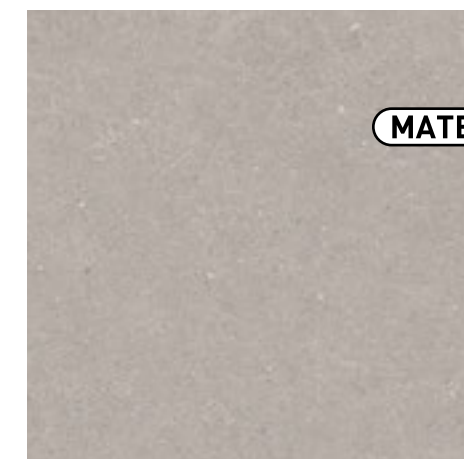

**60x60 PORCELÂNICO**

**C20/28**

Série: **Officina Cloud - Natural**

Ref.: ROF6060CLM



5 606779 208781





PE

Porcelânico Esmaltado  
Glazed tiles, Grès cérame émaillé,  
Feinsteinzeug Glasiert, Porcelânico esmaltado

RET

Retificado  
Rectified / Rectifié / Verarbeitet / Rectificado



Pisos e Paredes  
Floor and Walls / Sols et Murs  
Wandfliesen und Bodenfliesen / Pisos y Paredes



Variação Média V3  
Average tone variation / Variation moyenne  
Durchschnittliche Tonhöhenchwankung  
Variación media de tono



Resistente ao gelo  
Frost resistant / Résistant au gel  
Frostbeständig / Resistente al hielo



Espessura  
Thickness / Épaisseur / Dicke / Grosor



Recomendamos o uso de niveladores  
Recommended levelers / craisillons auto-nivellants conseillé  
Empfohlene Richtmaschinen / Niveladores recomendados

PCS

2 Pcs  
1,44 m<sup>2</sup>  
31 Kg

PAL

30 Cx  
43,20 m<sup>2</sup>  
945 Kg

Degraus rodapés e peças especiais  
na página 264 a 275.

## NewBur White



60x120 PORCELÂNICO

C26/37

Série: **NewBur White - Mate**

Ref.: RNB60120WM



5 606779 216625

## Rock Grey

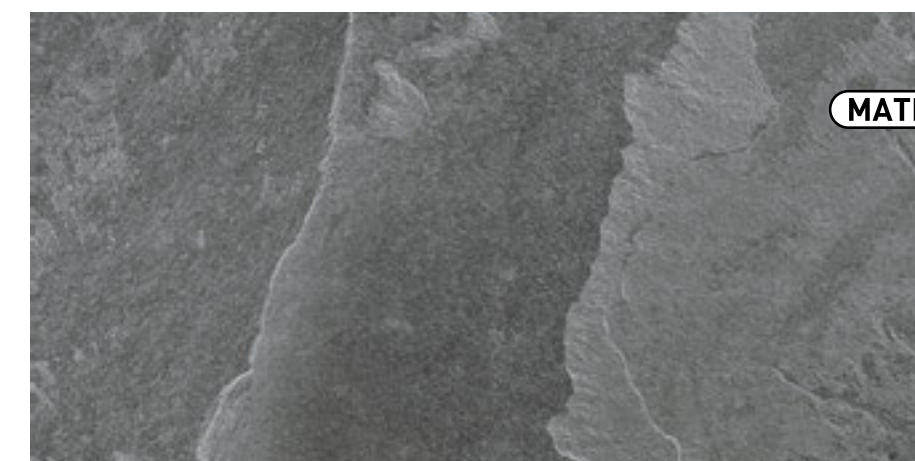

60x120 PORCELÂNICO

C26/37

Série: **Rock Grey - Mate**

Ref.: RRO60120GRP



5 606779 216632





Porcelânico Esmaltado  
Glazed tiles, Grès cérame émaillé,  
Feinsteinzeug Glasiert, Porcelánico esmaltado



Retificado  
Rectified / Rectifié / Verarbeitet / Rectificado



Pisos e Paredes  
Floor and Walls / Sols et Murs  
Wandfliesen und Bodenfliesen / Pisos y Paredes



Variação Média V3  
Average tone variation / Variation moyenne  
Durchschnittliche Tonhöhenchwankung  
Variación media de tono



Resistente ao gelo  
Frost resistant / Résistant au gel  
Frostbeständig / Resistente al hielo



Espessura  
Thickness / Épaisseur / Dicke / Grosor



Recomendamos o uso de niveladores  
Recommended levelers / crasillons auto-nivellants conseillé  
Empfohlene Richtmaschinen / Niveladores recomendados



**60x120**  
2 Pcs  
1,44 m<sup>2</sup>  
31 Kg



**PAL**  
32 Cx  
46,08 m<sup>2</sup>  
1.010 Kg

Degraus rodapés e peças especiais  
na página 264 a 275.

# Terrazo Grey

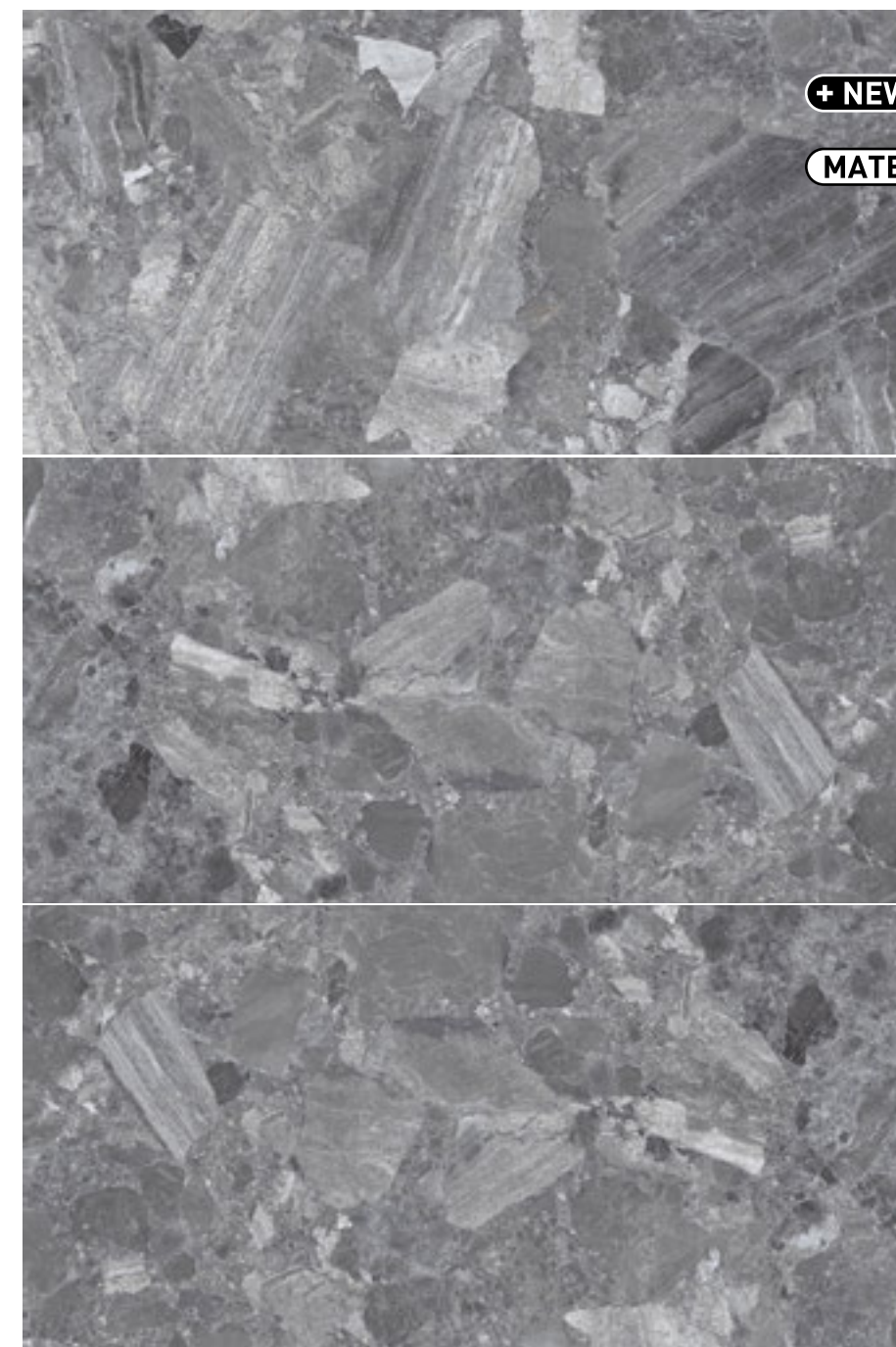

**60x120 PORCELÂNICO**

**C26/37**

Série: **Terrazo Grey - Mate**

Ref: **RTR12060TERGRM**



5 606779 253187





PE

Porcelânico Esmaltado  
Glazed tiles, Grès cérame émaillé,  
Feinsteinzeug Glasiert, Porcelánico esmaltado

RET

Retificado  
Rectified / Rectifié / Verarbeitet / Rectificado



Pisos e Paredes  
Floor and Walls / Sols et Murs  
Wandfliesen und Bodenfliesen / Pisos y Paredes



Variação Média V4



Resistente ao gelo  
Frost resistant / Résistant au gel  
Frostbeständig / Resistente al hielo



Espessura  
Thickness / Épaisseur / Dicke / Grosor



Recomendamos o uso de niveladores  
Recommended levelers / craisillons auto-nivellants conseillé  
Empfohlene Richtmaschinen / Niveladores recomendados



PCS  
2 Pcs  
1,44 m<sup>2</sup>  
30,6 Kg



PAL  
32 Cx  
46,08 m<sup>2</sup>  
1.010 Kg

Degraus rodapés e peças especiais  
na página 264 a 275.

## Steel Corten



60x120 PORCELÂNICO

C26/37

Série: **Steel Corten - Natural**

Ref.: RSC60120



5 606779 171085

## Steel Denim



60x120 PORCELÂNICO

C26/37

Série: **Steel Corten Denim - Natural**

Ref.: RSC60120D



5 606779 171092





Massa colorada  
Color Body, Pâte colorée,  
Durchgefärbtes, Coloración en masa



Retificado  
Rectified / Rectifié / Verarbeitet / Rectificado



Pisos e Paredes  
Floor and Walls / Sols et Murs  
Wandfliesen und Bodenfliesen / Pisos y Paredes



Variação Média V2  
Average tone variation / Variation moyenne  
Durchschnittliche Tonhöhenchwankung  
Variación media de tono



Resistente ao gelo  
Frost resistant / Résistant au gel  
Frostbeständig / Resistente al hielo



Espessura  
Thickness / Épaisseur / Dicke / Grosor



Recomendamos o uso de niveladores  
Recommended levelers / craisillons auto-nivellants conseillé  
Empfohlene Richtmaschinen / Niveladores recomendados



**60x120**  
2 Pcs  
1,44 m<sup>2</sup>  
29,7 Kg



**60x60**  
4 Pcs  
1,44 m<sup>2</sup>  
28 Kg



**PAL**  
35 Cx  
50,40 m<sup>2</sup>  
1.053 Kg



**PAL**  
32 Cx  
46,08 m<sup>2</sup>  
920 Kg

Degraus rodapés e peças especiais  
na página 264 a 275.

## Ark Silver

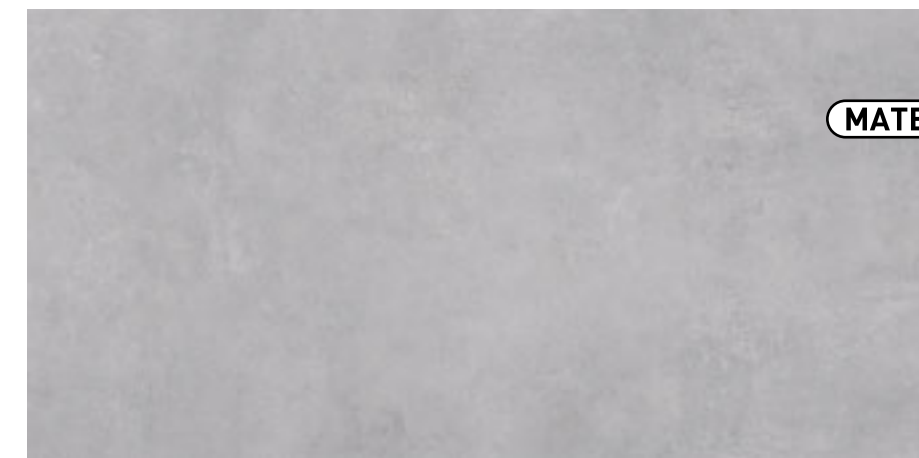

**60x120 PORCELÂNICO**

**C35/49**

Série: **Ark Silver - Natural**

Ref.: RH60120SIL



5 606779 196156



**60x60 PORCELÂNICO**

**C28/40**

Série: **Ark Silver - Natural**

Ref.: RH6060SIL



5 606779 194619





Massa colorada  
Color Body, Pâte colorée,  
Durchgefärbtes, Coloración en masa



Retificado  
Rectified / Rectifié / Verarbeitet / Rectificado



Pisos e Paredes  
Floor and Walls / Sols et Murs  
Wandfliesen und Bodenfliesen / Pisos y Paredes



Variação Média V2  
Average tone variation / Variation moyenne  
Durchschnittliche Tonhöhenchwankung  
Variación media de tono



Resistente ao gelo  
Frost resistant / Résistant au gel  
Frostbeständig / Resistente al hielo



Espessura  
Thickness / Épaisseur / Dicke / Grosor



Recomendamos o uso de niveladores  
Recommended levelers / craisillons auto-nivellants conseillé  
Empfohlene Richtmaschinen / Niveladores recomendados



**100x100**  
2 Pcs  
2 m<sup>2</sup>  
48,54 Kg



**60x60**  
4 Pcs  
1,44 m<sup>2</sup>  
28 Kg



**PAL**  
24 Cx  
48 m<sup>2</sup>  
1.185 Kg



**PAL**  
32 Cx  
46,08 m<sup>2</sup>  
920 Kg

Degraus rodapés e peças especiais  
na página 264 a 275.

# Ark Ivory

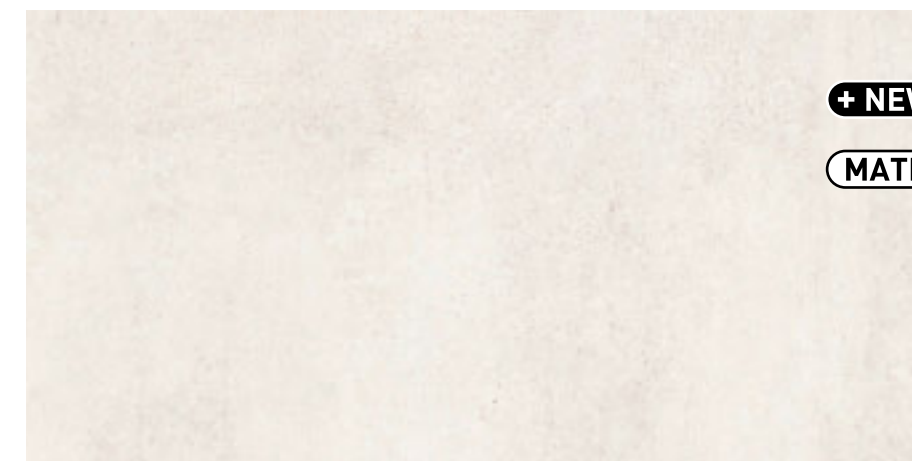

**+ NEW**

**MATE**



**60x120 PORCELÂNICO**

**C35/49**

Série: **Ark Ivory - Mate**

Ref.: RH60120IVR



5 606779 196170



**60x60 PORCELÂNICO**

**C28/40**

Série: **Ark Ivory - Mate**

Ref.: RH6060IVR



5 606779 194633



**MATE**

**100x100 PORCELÂNICO**

**C38/54**

Série: **Ark Ivory - Natural**

Ref.: RH100100IVR



5 606779 196187





Porcelânico Esmaltado  
Glazed tiles, Grès cérame émaillé,  
Feinsteinzeug Glasiert, Porcelánico esmaltado



Retificado  
Rectified / Rectifié / Verarbeitet / Rectificado



Pisos e Paredes  
Floor and Walls / Sols et Murs  
Wandfliesen und Bodenfliesen / Pisos y Paredes



Variação Média V3  
Average tone variation / Variation moyenne  
Durchschnittliche Tonhöhenchwankung  
Variación media de tono



Resistente ao gelo  
Frost resistant / Résistant au gel  
Frostbeständig / Resistente al hielo



9 mm  
Espessura  
Thickness / Épaisseur / Dicke / Grosor



Recomendamos o uso de niveladores  
Recommended levelers / craillons auto-nivellants conseillé  
Empfohlene Richtmaschinen / Niveladores recomendados



90x90  
2 Pcs  
1,61 m<sup>2</sup>  
51,50 Kg



30 Cx  
48,30 m<sup>2</sup>  
1264 Kg

Degraus rodapés e peças especiais  
na página 264 a 275.

## Montblanc

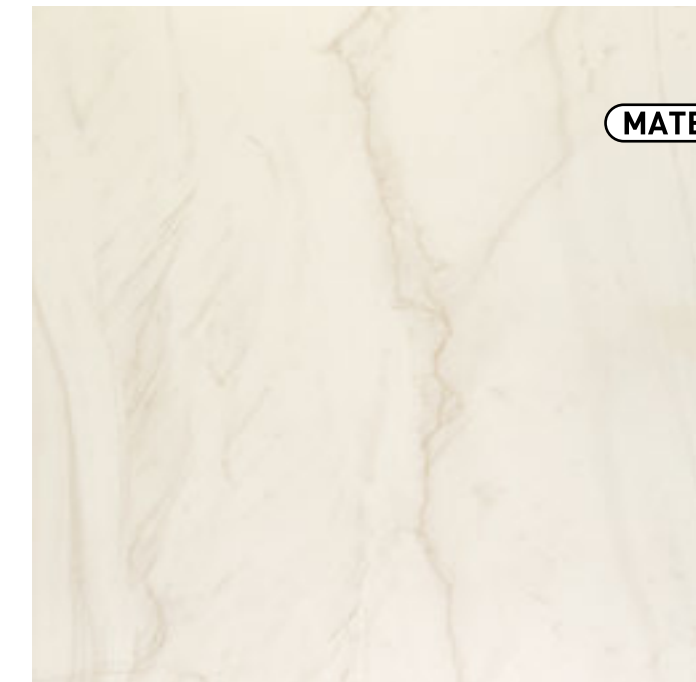

90x90 PORCELÂNICO

C40/56

Série: **Montblanc - Natural**

Ref.: RMB9090MBNA



5 606779 204196

## Silos



90x90 PORCELÂNICO

C36/50

Série: **Silos Touch Concept - Natural**

Ref.: R27643E



5 606779 204875



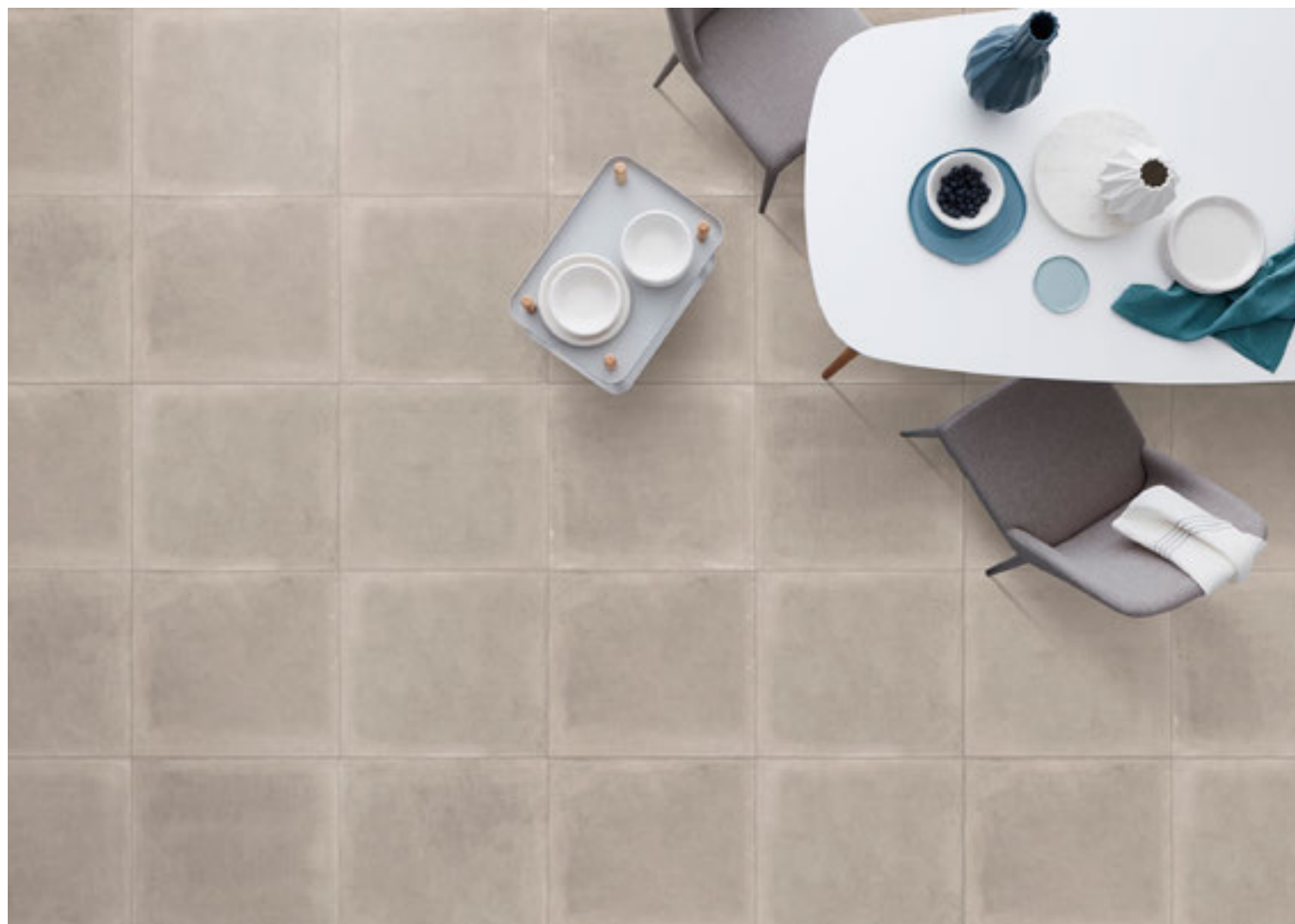

PE

Porcelânico Esmaltado  
Glazed tiles, Grès cérame émaillé,  
Feinsteinzeug Glasiert, Porcelánico esmaltado

RET

Retificado  
Rectified / Rectifié / Verarbeitet / Rectificado



Pisos e Paredes  
Floor and Walls / Sols et Murs  
Wandfliesen und Bodenfliesen / Pisos y Paredes



Variação Média V3  
Average tone variation / Variation moyenne  
Durchschnittliche Tonhöhenchwankung  
Variación media de tono



Resistente ao gelo  
Frost resistant / Résistant au gel  
Frostbeständig / Resistente al hielo



Espessura  
Thickness / Épaisseur / Dicke / Grosor



Recomendamos o uso de niveladores  
Recommended levelers / craisillons auto-nivellants conseillé  
Empfohlene Richtmaschinen / Niveladores recomendados

PCS

4 Pcs  
1,44 m<sup>2</sup>  
28,5 Kg

PAL

40 Cx  
57,60 m<sup>2</sup>  
1.160 Kg

Degraus rodapés e peças especiais  
na página 255 e 256.

## Officina & Hangar

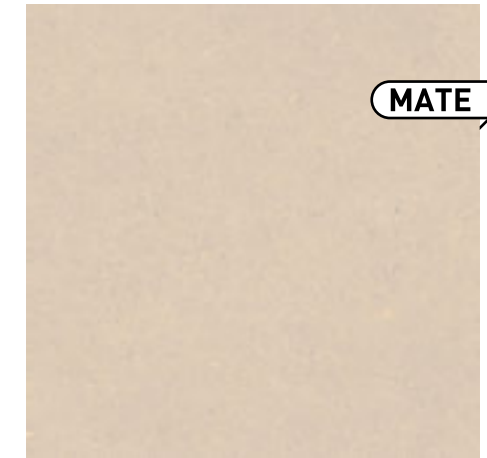

60x60 PORCELÂNICO

C20/28

Série: **Officina Nude**

Ref.: ROF6060NUM



5 606779 208798



60x60 PORCELÂNICO

C20/28

Série: **Hangar Soft Grey**

Ref.: RHA6060SGM



5 606779 208767



60x60 PORCELÂNICO

C20/28

Série: **Hangar Charcoal**

Ref.: RHA6060CHM



5 606779 208774





Porcelânico Esmaltado  
Glazed tiles, Grès cérame émaillé,  
Feinsteinzeug Glasiert, Porcelánico esmaltado



Retificado  
Rectified / Rectifié / Verarbeitet / Rectificado



Pisos e Paredes  
Floor and Walls / Sols et Murs  
Wandfliesen und Bodenfliesen / Pisos y Paredes



Variação Média V3  
Average tone variation / Variation moyenne  
Durchschnittliche Tonhöhenchwankung  
Variación media de tono



Resistente ao gelo  
Frost resistant / Résistant au gel  
Frostbeständig / Resistente al hielo



Espessura  
Thickness / Épaisseur / Dicke / Grosor



Recomendamos o uso de niveladores  
Recommended levelers / craisillons auto-nivellants conseillé  
Empfohlene Richtmaschinen / Niveladores recomendados



PCS  
2 Pcs  
1,44 m<sup>2</sup>  
28 Kg



PAL  
36 Cx  
51,84 m<sup>2</sup>  
1.042 Kg

Degraus rodapés e peças especiais  
na página 264 a 275.

## Chevron Natura

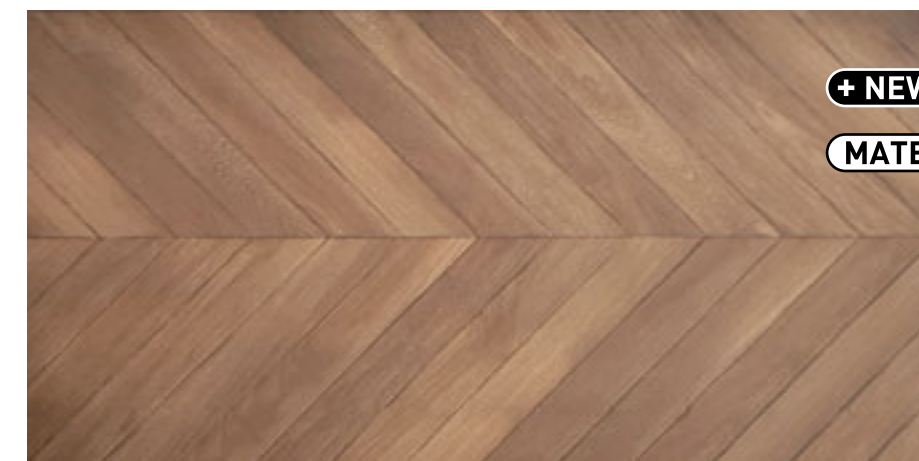

60x120 PORCELÂNICO

C36/50

Série: **Chevron Natura - Mate**

Ref.: RC60120CHNA1



5 606779 251633

## Chevron Terra

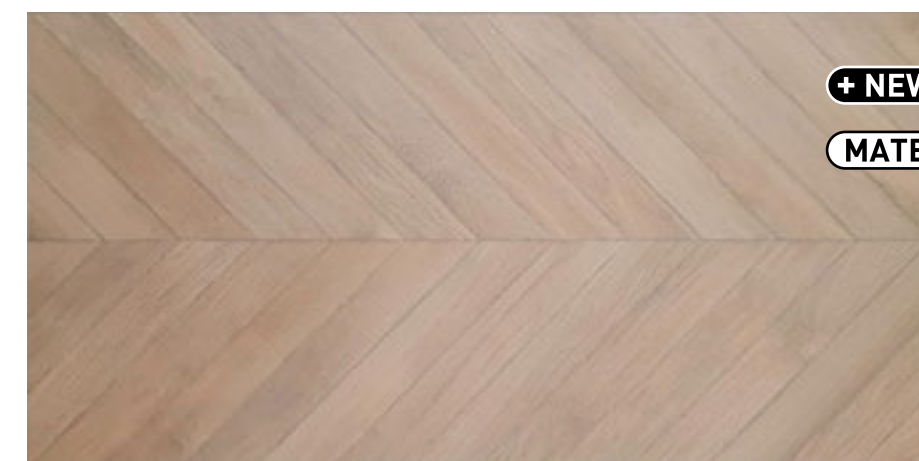

60x120 PORCELÂNICO

C36/50

Série: **Chevron Terra - Mate**

Ref.: RC60120CHTE1



5 606779 251626





Porcelânico Esmaltado  
Glazed tiles, Grès cérame émaillé,  
Feinsteinzeug Glasiert, Porcelánico esmaltado



Retificado  
Rectified / Rectifié / Verarbeitet / Rectificado



Pisos e Paredes  
Floor and Walls / Sols et Murs  
Wandfliesen und Bodenfliesen / Pisos y Paredes



Variação Média V3  
Average tone variation / Variation moyenne  
Durchschnittliche Tonhöhenchwankung  
Variación media de tono



Resistente ao gelo  
Frost resistant / Résistant au gel  
Frostbeständig / Resistente al hielo



Espessura  
Thickness / Épaisseur / Dicke / Grosor



Recomendamos o uso de niveladores  
Recommended levelers / craisillons auto-nivellants conseillé  
Empfohlene Richtmaschinen / Niveladores recomendados



CX  
7 Pcs  
1,68 m<sup>2</sup>  
32 Kg



PAL  
44 Cx  
73,92 m<sup>2</sup>  
1408 Kg

Degraus rodapés e peças especiais  
na página 264 a 275.

# Sunset

PORCELÂNICOS



20x120 PORCELÂNICO

C28/40

Série: **Sunset Camel - Natural**

Ref.: RSS20120CML



5 606779 230102



20x120 PORCELÂNICO

C28/40

Série: **Sunset Avela - Natural**

Ref.: RSS20120AVE



5 606779 230096





Porcelânico Esmaltado  
Glazed tiles, Grès cérame émaillé,  
Feinsteinzeug Glasiert, Porcelánico esmaltado



Retificado  
Rectified / Rectifié / Verarbeitet / Rectificado



Pisos e Paredes  
Floor and Walls / Sols et Murs  
Wandfliesen und Bodenfliesen / Pisos y Paredes



Variação Média V3  
Average tone variation / Variation moyenne  
Durchschnittliche Tonhöhenchwankung  
Variación media de tono



Resistente ao gelo  
Frost resistant / Résistant au gel  
Frostbeständig / Resistente al hielo



Espessura  
Thickness / Épaisseur / Dicke / Grosor



Recomendamos o uso de niveladores  
Recommended levelers / croisillons auto-nivellants conseillé  
Empfohlene Richtmaschinen / Niveladores recomendados



7 Pcs  
1,68 m<sup>2</sup>  
32 Kg



44 Cx  
73,92 m<sup>2</sup>  
1408 Kg

Degraus rodapés e peças especiais  
na página 264 a 275.

# Sunset



20x120 PORCELÂNICO

C28/40

Série: **Sunset Tabaco - Natural**

Ref.: RSS20120TBC

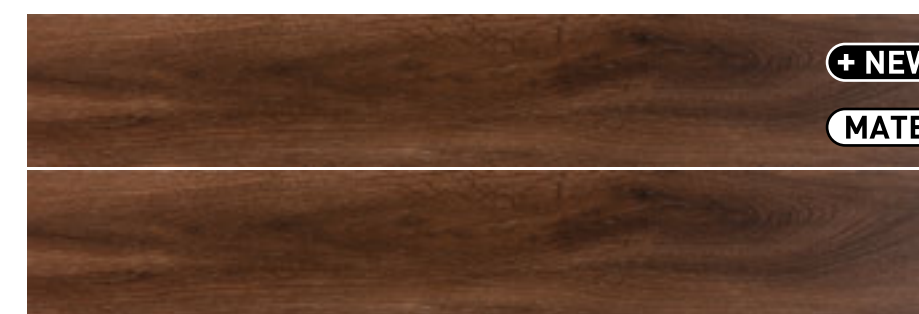

20x120 PORCELÂNICO

C28/40

Série: **Sunset Nogal - Natural**

Ref.: RSS20120NGL



20x120 PORCELÂNICO

C28/40

Série: **Sunset Gris - Natural**

Ref.: RSS20120GRS







R11

Resistência ao Deslizamento  
Slip resistance, Résistance à la glissance,  
Rutschkoeffizient, Resistencia al deslizamiento

PE

Porcelânico Esmaltado  
Glazed tiles, Grès cérame émaillé,  
Feinsteinzeug Glasiert, Porcelânico esmaltado

RET

Retificado  
Rectified / Rectifié / Verarbeitet / Rectificado



Pisos e Paredes  
Floor and Walls / Sols et Murs  
Wandfliesen und Bodenfliesen / Pisos y Paredes



Variação Média V3  
Average tone variation / Variation moyenne  
Durchschnittliche Tonhöhenchwankung  
Variación media de tono



Resistente ao gelo  
Frost resistant / Résistant au gel  
Frostbeständig / Resistente al hielo



Espessura  
Thickness / Épaisseur / Dicke / Grosor



Recomendamos o uso de niveladores  
Recommended levelers / craisillons auto-nivellants conseillé  
Empfohlene Richtmaschinen / Niveladores recomendados

23x120

5 Pcs  
1,38 m<sup>2</sup>  
26,60 Kg

PAL

48 Cx  
66,24 m<sup>2</sup>  
1.276 Kg

Degraus rodapés e peças especiais  
na página 264 a 275.

# Deck Cerâmico



23x120 PORCELÂNICO

C27/38

Série: **Nogal - EXT**

Ref.: RSD23120NG



5 606779 230126



23x120 PORCELÂNICO

C27/38

Série: **Camel - EXT**

Ref.: RSD23120TBC



5 606779 230140



23x120 PORCELÂNICO

C27/38

Série: **Gris - EXT**

Ref.: RSD23120GRS



5 606779 250551





R11

Resistência ao Deslizamento  
Slip resistance, Résistance à la glissance,  
Rutschkoeffizient, Resistencia al deslizamiento

PE

Porcelânico Esmaltado  
Glazed tiles, Grès cérame émaillé,  
Feinsteinzeug Glasiert, Porcelânico esmaltado

RET

Retificado  
Rectified / Rectifié / Verarbeitet / Rectificado

Pisos e Paredes  
Floor and Walls / Sols et Murs  
Wandfliesen und Bodenfliesen / Pisos y Paredes

Variação Média V3  
Average tone variation / Variation moyenne  
Durchschnittliche Tonhöhenchwankung  
Variación media de tono

Resistente ao gelo  
Frost resistant / Résistant au gel  
Frostbeständig / Resistente al hielo

Espessura  
Thickness / Épaisseur / Dicke / Grosor

Recomendamos o uso de niveladores  
Recommended levelers / craisillons auto-nivellants conseillé  
Empfohlene Richtmaschinen / Niveladores recomendados

23x120

5 Pcs  
1,38 m<sup>2</sup>  
26,60 Kg

20x120

5 Pcs  
1,19 m<sup>2</sup>  
29,40 Kg

PAL

48 Cx  
66,24 m<sup>2</sup>  
1.276 Kg

PAL

45 Cx  
53,55 m<sup>2</sup>  
1.341 Kg

Degraus rodapés e peças especiais  
na página 264 a 275.

# Deck Cerâmico

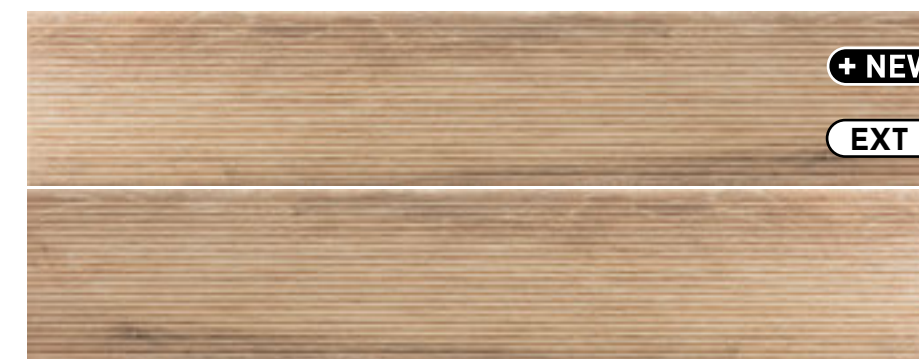

ANTI-SLIP FLOOR

23x120 PORCELÂNICO

C27/38

Série: **Borneo Straw - EXT**

Ref.: RD23120BOST1

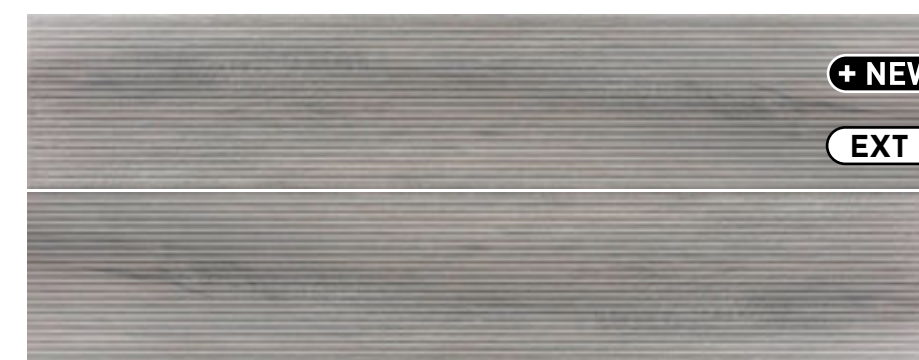

ANTI-SLIP FLOOR

23x120 PORCELÂNICO

C27/38

Série: **Borneo Gris - EXT**

Ref.: RD23120BOGRI

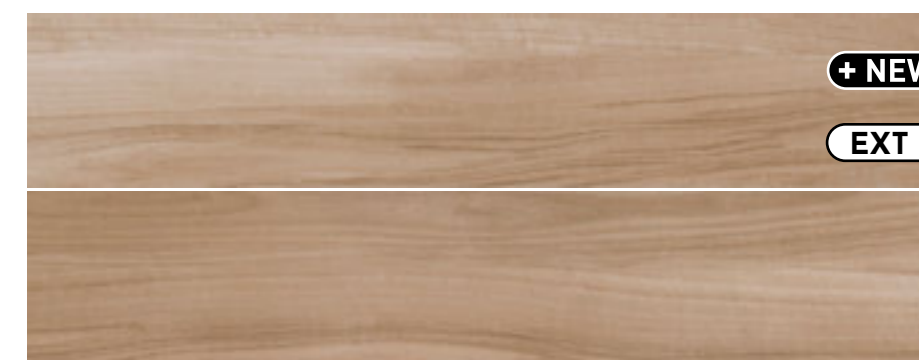

ANTI-SLIP FLOOR

20x120 PORCELÂNICO

C32/45

Série: **Authentique Auracaria - EXT**

Ref.: RA20120AUEXT







R11

Resistência ao Deslizamento  
Slip resistance, Résistance à la glissance,  
Rutschkoeffizient, Resistencia al deslizamiento

PE

Porcelânico Esmaltado  
Glazed tiles, Grès cérame émaillé,  
Feinsteinzeug Glasiert, Porcelânico esmaltado

RET

Retificado  
Rectified / Rectifié / Verarbeitet / Rectificado

ANTI-SLIP FLOOR

Pisos e Paredes  
Floor and Walls / Sols et Murs  
Wandfliesen und Bodenfliesen / Pisos y Paredes

Variación Média V3

Average tone variation / Variation moyenne  
Durchschnittliche Tonhöhenchwankung  
Variación media de tono

Resistente ao gelo

Frost resistant / Résistant au gel  
Frostbeständig / Resistente al hielo

9 mm

Espessura  
Thickness / Épaisseur / Dicke / Grosor

Recomendamos o uso de niveladores

Recommended levelers / craisillons auto-nivellants conseillé  
Empfohlene Richtmaschinen / Niveladores recomendados

PCS

2 Pcs  
1,44 m<sup>2</sup>  
31 Kg

PAL

32 Cx  
46,08 m<sup>2</sup>  
1.010 Kg

Degraus rodapés e peças especiais  
na página 264 a 275.

# Intenso Bianco



+ NEW

EXT

R11

60x120 PORCELÂNICO R11

C26/37

Série: Intenso Bianco - EXT

Ref.: RI60120IBEXT



5 606779 253149



R11

60x60 PORCELÂNICO R11

C20/28

Série: Intenso Bianco - EXT

Ref.: RI6060IBEXT



5 606779 253156

# Intenso Argento

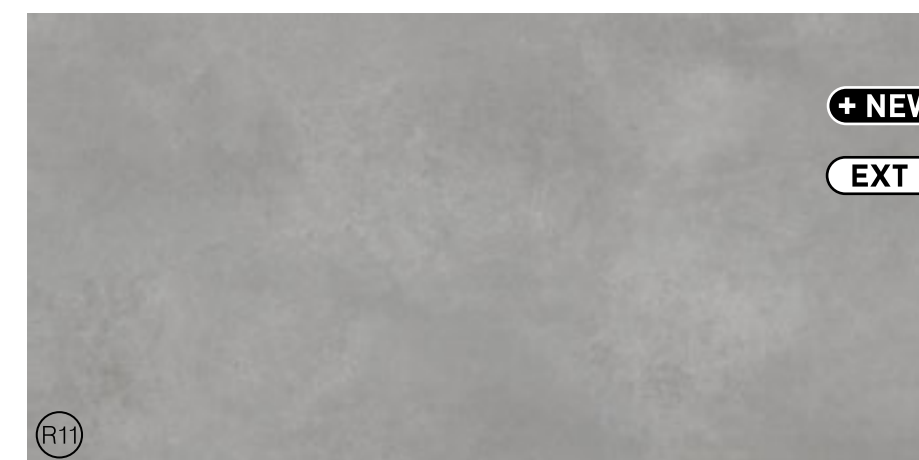

+ NEW

EXT

R11

60x120 PORCELÂNICO R11

C26/37

Série: Intenso Argento - EXT

Ref.: RI60120IAREXT



5 606779 253170



R11

60x60 PORCELÂNICO R11

C20/28

Série: Intenso Argento - EXT

Ref.: RI6060IAREXT



5 606779 253163



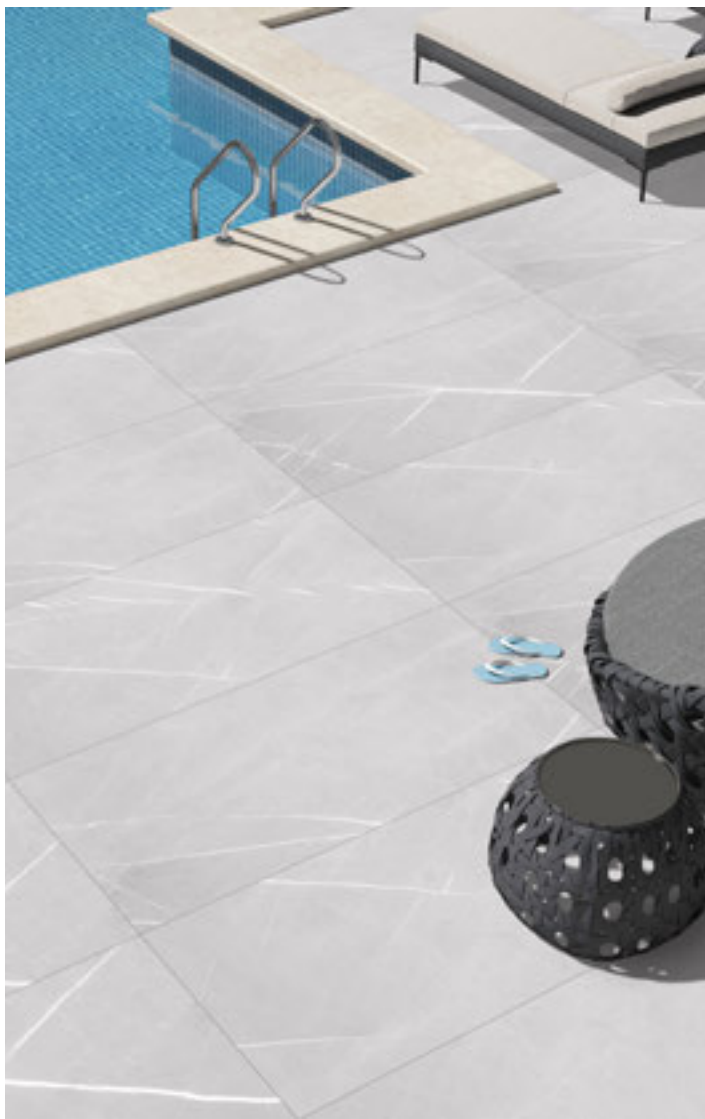

**R11**  
 Resistência ao Deslizamento  
 Slip resistance, Résistance à la glissance,  
 Rutschkoeffizient, Resistencia al deslizamiento

**PE**  
 Porcelânico Esmaltado  
 Glazed tiles, Grès cérame émaillé,  
 Feinsteinzeug Glasiert, Porcelánico esmaltado

**RET**  
 Retificado  
 Rectified / Rectifié / Verarbeitet / Rectificado

**ANTI SLIP FLOOR**  
 Pisos e Paredes  
 Floor and Walls / Sols et Murs  
 Wandfliesen und Bodenfliesen / Pisos y Paredes

**Variação Média V3**  
 Average tone variation / Variation moyenne  
 Durchschnittliche Tonhöhen schwankung  
 Variación media de tono

**Resistente ao gelo**  
 Frost resistant / Résistant au gel  
 Frostbeständig / Resistente al hielo

**9 mm**  
 Espessura  
 Thickness / Épaisseur / Dicke / Grosor

**Recomendamos o uso de niveladores**  
 Recommended levelers / craillons auto-nivellants conseillé  
 Empfohlene Richtmaschinen / Niveladores recomendados

**PCS**  
 2 Pcs  
 1,44 m<sup>2</sup>  
 31 Kg

**PAL**  
 32 Cx  
 46,08 m<sup>2</sup>  
 1.010 Kg

Degraus rodapés e peças especiais  
 na página 264 a 275.

# Piäsentina Bianco



**60x120 PORCELÂNICO R11** **C26/37**  
 Série: **Piäsentina Bianco - EXT**  
 Ref.: RPI60120BIEXT

**60x60 PORCELÂNICO R11** **C20/28**  
 Série: **Piäsentina Bianco - EXT**  
 Ref.: RPI6060BIEXT

# Piäsentina Silver

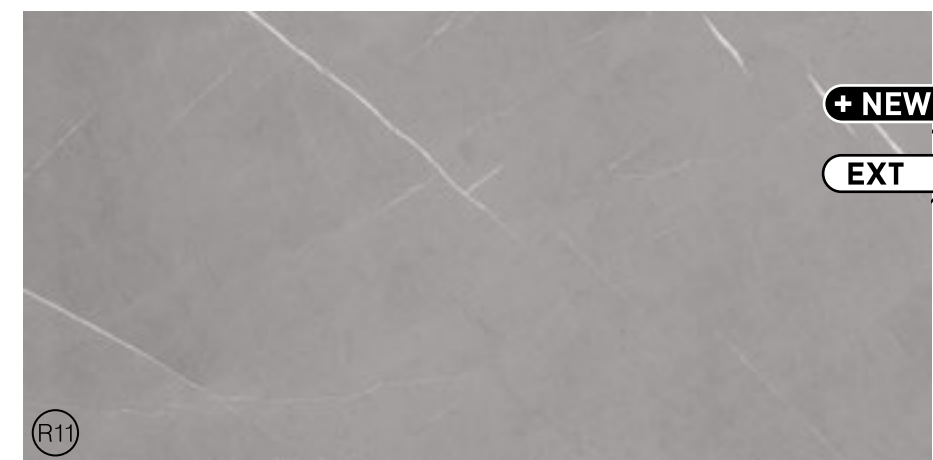

**60x120 PORCELÂNICO R11** **C26/37**  
 Série: **Piäsentina Silver - EXT**  
 Ref.: RPI60120SILEXT

**60x60 PORCELÂNICO R11** **C20/28**  
 Série: **Piäsentina Silver - EXT**  
 Ref.: RPI6060SILEXT



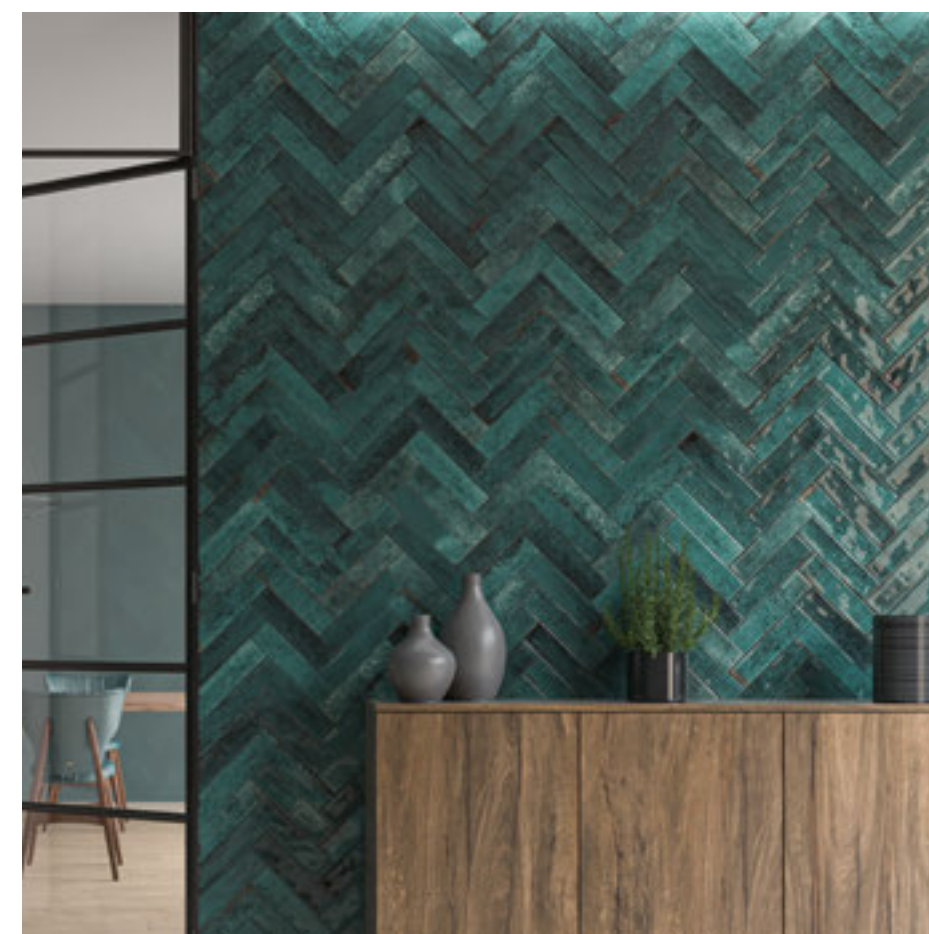

## REVESTIMIENTO DE PAREDES

Wall Tiles / Revêtement Mural

Wandfliesen / Azulejos De La Pared





Porcelânico Esmaltado  
Glazed tiles, Grès cérame émaillé,  
Feinsteinzeug Glasiert, Porcelánico esmaltado



Retificado  
Rectified / Rectifié / Verarbeitet / Rectificado



Paredes  
Walls / Mur / Wandfliesen / Paredes



Varição Média V3  
Average tone variation / Variation moyenne  
Durchschnittliche Tonhöhenchwankung  
Variación media de tono



Espessura  
Thickness / Épaisseur / Dicke / Grosor



Recomendamos o uso de niveladores  
Recommended levelers / crassillons auto-nivellants conseillé  
Empfohlene Richtmaschinen / Niveladores recomendados



**PCS**  
25 Pcs  
0,56 m<sup>2</sup>  
9 Kg



**PAL**  
121 Cx  
67,76 m<sup>2</sup>  
1.089 Kg

# Brick

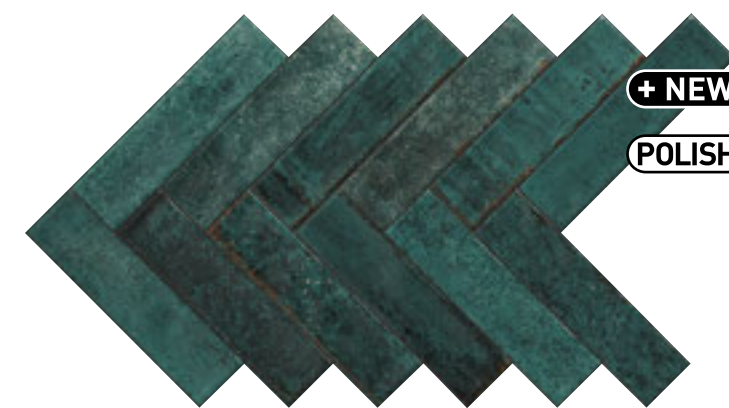

\* Sugestão de aplicação

7,5x30 PORCELÂNICO

**C36/50**

Série: **Brick Blue - Polido**

Ref.: RB75300BRBLUE



5 606779 250131



\* Sugestão de aplicação

7,5x30 PORCELÂNICO

**C36/50**

Série: **Brick Black - Polido**

Ref.: RB75300BRBLK



5 606779 250117





Porcelânico Esmaltado  
Glazed tiles, Grès cérame émaillé,  
Feinsteinzeug Glasiert, Porcelânico esmaltado



Retificado  
Rectified / Rectifié / Verarbeitet / Rectificado



Paredes  
Walls / Mur / Wandfliesen / Paredes



Variação Média V3  
Average tone variation / Variation moyenne  
Durchschnittliche Tonhöhenchwankung  
Variación media de tono



Espessura  
Thickness / Épaisseur / Dicke / Grosor



Recomendamos o uso de niveladores  
Recommended levelers / crassillons auto-nivellants conseillé  
Empfohlene Richtmaschinen / Niveladores recomendados



**PCS**  
25 Pcs  
0,56 m<sup>2</sup>  
9 Kg



**PAL**  
121 Cx  
67,76 m<sup>2</sup>  
1.089 Kg

# Brick



\* Sugestão de aplicação

**7,5x30 PORCELÂNICO**

**C36/50**

Série: **Brick Grey - Polido**

Ref.: RB75300BRGREY

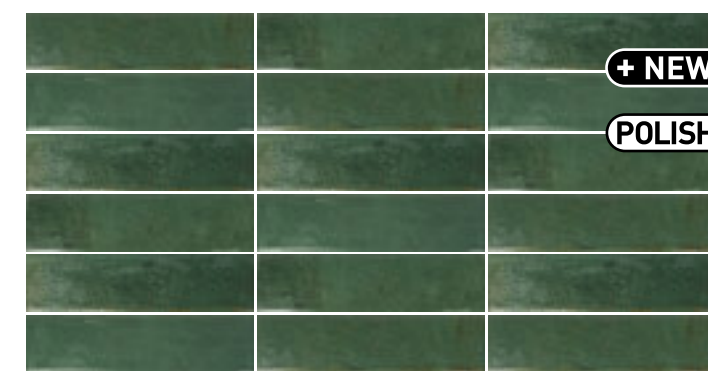

\* Sugestão de aplicação

**7,5x30 PORCELÂNICO**

**C36/50**

Série: **Brick Green - Polido**

Ref.: RB75300BRGRN



\* Sugestão de aplicação

**7,5x30 PORCELÂNICO**

**C36/50**

Série: **Brick White - Polido**

Ref.: RB75300BRWHI







Porcelânico Esmaltado  
Glazed tiles, Grès cérame émaillé,  
Feinsteinzeug Glasiert, Porcelánico esmaltado



Mate  
Matt / Mat / Mattes / Mate



Interiores e Exteriores  
Indoors and outdoors / Intérieurs et extérieurs  
Drinnen und draußen / Interior y exterior



Variação Média V1  
Average tone variation / Variation moyenne  
Durchschnittliche Tonhöhenchwankung  
Variación media de tono



Resistente ao gelo  
Frost resistant / Résistant au gel  
Frostbeständig / Resistente al hielo



Espessura  
Thickness / Épaisseur / Dicke / Grosor



Cola para porcelânicos  
Porcelain Adhesive / Colle pour grès cérame  
Kleber für Porzellanfliesen / Pegamento para porcelánico



100 Pcs  
1 m<sup>2</sup>  
20,50 Kg

# Porcelânico 3D

Porcelânico para Interiores e Exteriores

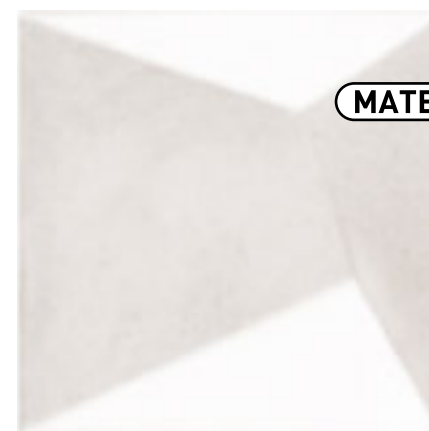

10x10cm **C70/98**

Cor: **White - Mate**

Ref.: RC9898MTWHT3D 

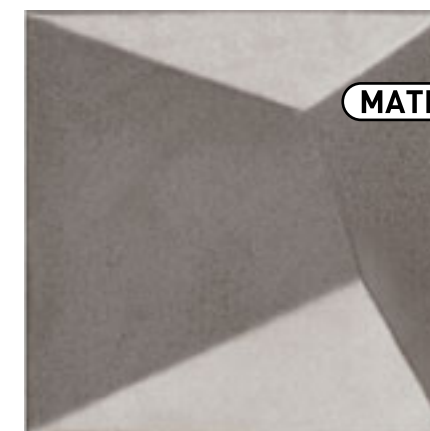

10x10cm **C70/98**

Cor: **Grey - Mate**

Ref.: RC9898MTGR3D 

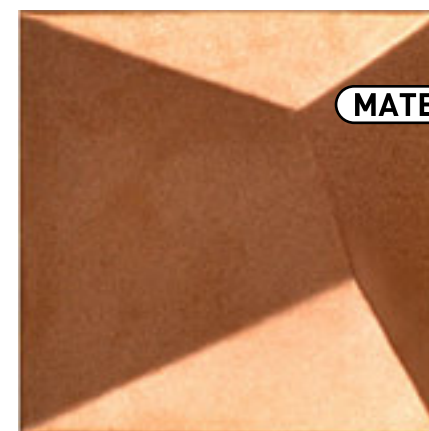

10x10cm **C125/175**

Cor: **Rose Gold - Mate**

Ref.: RC9898MTRSG3D 



10x10cm **C70/98**

Cor: **Black - Mate**

Ref.: RC9898MTBLK3D 





Porcelânico Esmaltado  
Glazed tiles, Grès cérame émaillé,  
Feinsteinzeug Glasiert, Porcelánico esmaltado



Retificado  
Rectified / Rectifié / Verarbeitet / Rectificado



Pisos e Paredes  
Floor and Walls / Sols et Murs  
Wandfliesen und Bodenfliesen / Pisos y Paredes



Variação Média V3  
Average tone variation / Variation moyenne  
Durchschnittliche Tonhöhen schwankung  
Variación media de tono



Resistente ao gelo  
Frost resistant / Résistant au gel  
Frostbeständig / Resistente al hielo



Espessura  
Thickness / Épaisseur / Dicke / Grosor



Recomendamos o uso de niveladores  
Recommended levelers / cratillons auto-nivellants conseillé  
Empfohlene Richtmaschinen / Niveladores recomendados



PCS  
2 Pcs  
1,44 m<sup>2</sup>  
28 Kg



PAL  
36 Cx  
51,84 m<sup>2</sup>  
1.042 Kg

# Trigono



60x120 PORCELÂNICO

C36/50

Série: Trigono Oak - Mate

Ref.: RC60120NAFU1

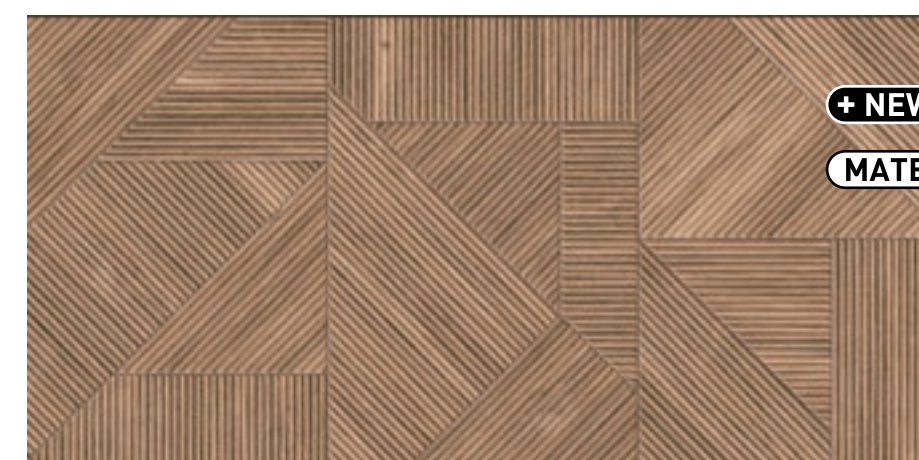

60x120 PORCELÂNICO

C36/50

Série: Trigono Cerezo - Mate

Ref.: RC60120NANA1



60x120 PORCELÂNICO

C36/50

Série: Trigono Gris - Mate

Ref.: RC60120NAGR1







Porcelânico Esmaltado  
Glazed tiles, Grès cérame émaillé,  
Feinsteinzeug Glasiert, Porcelánico esmaltado



Retificado  
Rectified / Rectifié / Verarbeitet / Rectificado



Pisos e Paredes  
Floor and Walls / Sols et Murs  
Wandfliesen und Bodenfliesen / Pisos y Paredes



Variação Média V3  
Average tone variation / Variation moyenne  
Durchschnittliche Tonhöhen schwankung  
Variación media de tono



Resistente ao gelo  
Frost resistant / Résistant au gel  
Frostbeständig / Resistente al hielo



Espessura  
Thickness / Épaisseur / Dicke / Grosor



Recomendamos o uso de niveladores  
Recommended levelers / craisillons auto-nivellants conseillé  
Empfohlene Richtmaschinen / Niveladores recomendados



PCS  
2 Pcs  
1,44 m<sup>2</sup>  
28 Kg



PAL  
36 Cx  
51,84 m<sup>2</sup>  
1.042 Kg

## Prisma



60x120 PORCELÂNICO

C36/50

Série: **Prisma Oak - Mate**

Ref.: RC60120POFUI



5 606779 251640

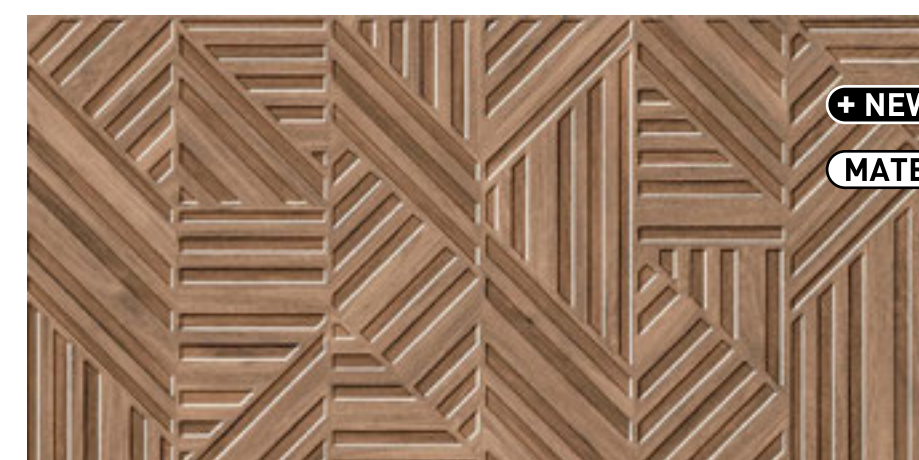

60x120 PORCELÂNICO

C36/50

Série: **Prisma Cerezo - Mate**

Ref.: RC60120PONA1



5 606779 251657



60x120 PORCELÂNICO

C36/50

Série: **Prisma Caen Mix - Mate**

Ref.: RC60120CA1



5 606779 251695





Porcelânico Esmaltado  
Glazed tiles, Grès cérame émaillé,  
Feinsteinzeug Glasiert, Porcelánico esmaltado



Retificado  
Rectified / Rectifié / Verarbeitet / Rectificado



Paredes  
Walls / Mur / Wandfliesen / Paredes



Variação Média V3  
Average tone variation / Variation moyenne  
Durchschnittliche Tonhöhenchwankung  
Variación media de tono



Espessura  
Thickness / Épaisseur / Dicke / Grosor



Recomendamos o uso de niveladores  
Recommended levelers / crasillons auto-nivellants conseillé  
Empfohlene Richtmaschinen / Niveladores recomendados



4 Cx  
1,44 m<sup>2</sup>  
31 Kg



36 Cx  
51,84 m<sup>2</sup>  
1130 Kg

# Western

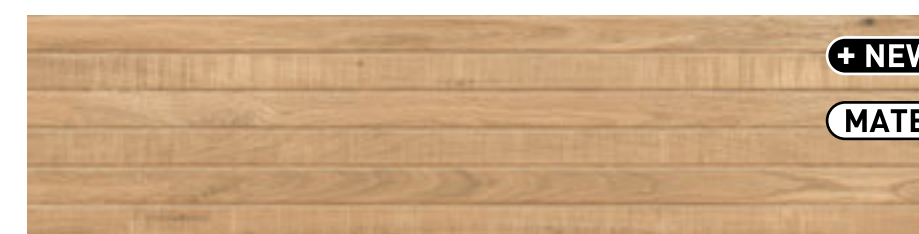

30x120 PORCELÂNICO

C32/45

Série: **Western Almond - Mate com relevo**

Ref.: RW30120WAL



5 606779 252777

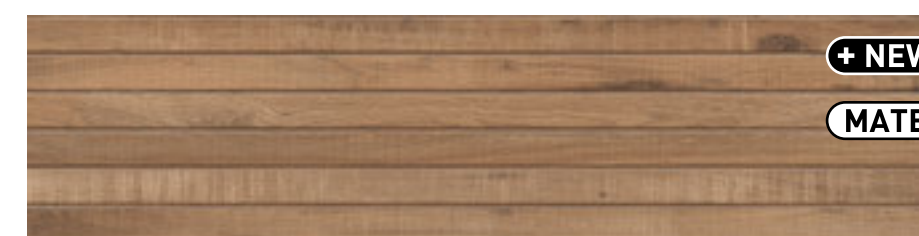

30x120 PORCELÂNICO

C32/45

Série: **Western Brun - Mate com relevo**

Ref.: RW30120WB



5 606779 252760



30x120 PORCELÂNICO

C32/45

Série: **Western Gris - Mate com relevo**

Ref.: RW30120WGR



5 606779 252784





Pasta Branca  
White Body / Pate Blanche  
Weiss-scherbig / Pasta Blanca



Retificado  
Rectified / Rectifié / Verarbeitet / Rectificado



Paredes  
Walls / Mur / Wandfliesen / Paredes



Variação Média V1  
Average tone variation / Variation moyenne  
Durchschnittliche Tonhöhenchwankung  
Variación media de tono



Espessura  
Thickness / Épaisseur / Dicke / Grosor



Recomendamos o uso de niveladores  
Recommended levelers / crasillons auto-nivellants conseillé  
Empfohlene Richtmaschinen / Niveladores recomendados



4 Pcs  
1,07 m<sup>2</sup>  
22,5 Kg



36 Cx  
38,52 m<sup>2</sup>  
915 Kg

# Walls



MATE

30x90 PASTA BRANCA

C30/42

Série: Walls Ripado Gris 3D - Natural

Ref.: RW3090RIPG



MATE

30x90 PASTA BRANCA

C30/42

Série: Walls Ripado Branco 3D - Natural

Ref.: RW3090RIPBRC

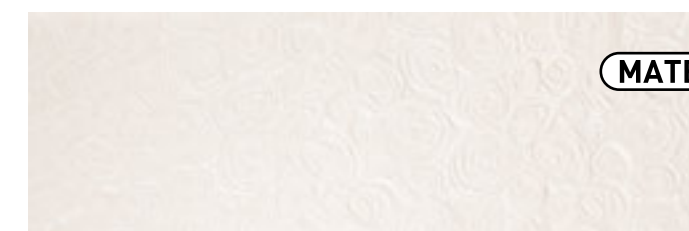

MATE

30x90 PASTA BRANCA

C30/42

Série: Walls Botanica - Natural

Ref.: RW3090B







Pasta Branca  
White Body / Pate Blanche  
Weiss-scherbig / Pasta Blanca



Retificado  
Rectified / Rectifié / Verarbeitet / Rectificado



Paredes  
Walls / Mur / Wandfliesen / Paredes



Variação Média V3  
Average tone variation / Variation moyenne  
Durchschnittliche Tonhöhenchwankung  
Variación media de tono



Espessura  
Thickness / Epaisseur / Dicke / Grosor



Recomendamos o uso de niveladores  
Recommended levelers / crasillons auto-nivellants conseillé  
Empfohlene Richtmaschinen / Niveladores recomendados



PCS

4 Pcs  
1,07 m<sup>2</sup>  
22,5 Kg



PCS

4 Pcs  
0,15 m<sup>2</sup>  
2,07 Kg



PAL

36 Cx  
38,52 m<sup>2</sup>  
915 Kg

# Walls



MATE

20x20 PASTA BRANCA

C75/105

Série: Walls Travertino Hexa 3D - Natural

Ref.: RTN2020CH



5 606779 190390



MATE

30x90 PASTA BRANCA

C30/42

Série: Walls Remy Crema - Natural

Ref.: RR309OCR



5 606779 169242



MATE

30x90 PASTA BRANCA

C30/42

Série: Walls Broadway Waves - Natural

Ref.: RC309OW



5 606779 153012



MATE

30x90 PASTA BRANCA

C30/42

Série: Walls Broadway Natural - Natural

Ref.: RC3090



5 606779 153005





Porcelânico Esmaltado  
Glazed tiles / Grès cérame émaillé,  
Feinsteinzeug Glasiert, Porcelânico esmaltado



Retificado  
Rectified / Rectifié / Verarbeitet / Rectificado



Paredes  
Walls / Mur / Wandfliesen / Paredes



Variação Média V4  
Average tone variation / Variation moyenne  
Durchschnittliche Tonhöhenchwankung  
Variación media de tono



Resistente ao gelo  
Frost resistant / Résistant au gel  
Frostbeständig / Resistente al hielo



Espessura  
Thickness / Épaisseur / Dicke / Grosor



Recomendamos o uso de niveladores  
Recommended levelers / craisillons auto-nivellants conseillé  
Empfohlene Richtmaschinen / Niveladores recomendados



60x60  
4 Pcs  
1,43 m<sup>2</sup>  
29,30 Kg



36 Cx  
51,48 m<sup>2</sup>  
1.076 Kg

# Mosaic 3D



60x60 PORCELÂNICO **C36/50**

Série: **3D Marmy Classico - Polish/Mate**

Ref.: RM3D6060CB

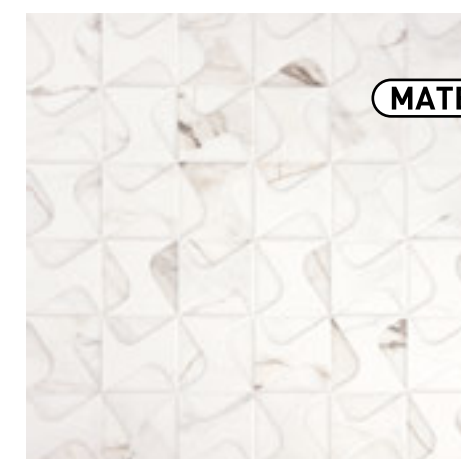

60x60 PORCELÂNICO **C36/50**

Série: **3D Marmy - Mate**

Ref.: RM3D6060M



60x60 PORCELÂNICO **C36/50**

Série: **3D Konkretus - Mate**

Ref.: RM3D6060C







Pasta Branca  
White Body / Pate Blanche  
Weiss-scherbig / Pasta Blanca



Retificado  
Rectified / Rectifié / Verarbeitet / Rectificado



Paredes  
Walls / Mur / Wandfliesen / Paredes



Variação Média V1  
Average tone variation / Variation moyenne  
Durchschnittliche Tonhöhenchwankung  
Variación media de tono



Espessura  
Thickness / Épaisseur / Dicke / Grosor



Recomendamos o uso de niveladores  
Recommended levelers / crasillons auto-nivellants conseillé  
Empfohlene Richtmaschinen / Niveladores recomendados



**30x90**  
4 Pcs  
1,08 m<sup>2</sup>  
23,44 Kg



**30x60**  
8 Pcs  
1,44 m<sup>2</sup>  
26 Kg



**PAL**  
20 Cx  
21,60 m<sup>2</sup>  
487 Kg



**PAL**  
36 Cx  
51,84 m<sup>2</sup>  
920 Kg

# Walls Branco Brilho e Mate

**POLISH**

**MATE**

**30x90 PASTA BRANCA**

**C25/35**

Série: **Walls Mekong - Gloss**

Ref.: 309039000



**30x90 PASTA BRANCA**

**C25/35**

Série: **Walls Volga - Mate**

Ref.: M309039000



**POLISH**

**MATE**

**30x60 PASTA BRANCA**

**C20/28**

Série: **Walls Mekong - Gloss**

Ref.: 306036000



**30x60 PASTA BRANCA**

**C20/28**

Série: **Walls Volga - Mate**

Ref.: M3060RJC60001







**ESPESSURADOS de 20mm**  
20mm Thickness / Carreaux d'épaisseur 20mm  
20mm dicke Fliesen / Baldosas de 20mm de espesor





R11

Resistência ao Deslizamento  
Slip resistance, Résistance à la glissance,  
Rutschkoeffizient, Resistencia al deslizamiento

MC

Massa colorada  
Color Body, Coloré dans la masse,  
Durchgefärbtes, Coloración en masa

RET

Retificado  
Rectified / Rectifié / Verarbeitet / Rectificado

Hand and shoe icon

Pisos e Paredes  
Floor and Walls / Sols et Murs  
Wandfliesen und Bodenfliesen / Pisos y Paredes

Color variation icon

Variação Média V2  
Average tone variation / Variation moyenne  
Durchschnittliche Tonhöhenchwankung  
Variación media de tono

Frost icon

Resistente ao gelo  
Frost resistant / Résistant au gel  
Frostbeständig / Resistente al hielo

20mm icon

Espessura  
Thickness / Épaisseur / Dicke / Grosor

Leveling icon

Recomendamos o uso de niveladores  
Recommended levelers / craisillons auto-nivellants conseillé  
Empfohlene Richtmaschinen / Niveladores recomendados

60x120  
2 Pcs  
1,44 m<sup>2</sup>  
62,25 Kg

60x60  
2 Pcs  
0,72 m<sup>2</sup>  
36 Kg

PAL  
16 Cx  
23,04 m<sup>2</sup>  
1015 Kg

PAL  
32 Pcs  
23,04 m<sup>2</sup>  
1152 Kg

Grates icon

Grilhas e outras peças especiais na  
Pág. 255 e 256

# Ark Ivory



R11

ANTI SLIP FLOOR

60x120x2 PORCELÂNICO EXT

C58/82

Série: Ark Ivory - ANTIDERRAPANTE

Ref.: RH601202IVRESP

\* Sob encomenda



5 606779 196460

2cm



R11

ANTI SLIP FLOOR

60x60x2 PORCELÂNICO EXT

C50/70

Série: Ark Ivory - ANTIDERRAPANTE

Ref.: RH60602IVRESP



Pedestais na Pág. 231



Grilhas e outras peças especiais na Pág. 255 e 256



5 606779 196255





R11

Resistência ao Deslizamento  
Slip resistance, Résistance à la glissance,  
Rutschkoeffizient, Resistencia al deslizamiento

MC

Massa colorada  
Color Body, Coloré dans la masse,  
Durchgefärbtes, Coloración en masa

RET

Retificado  
Rectified / Rectifié / Verarbeitet / Rectificado

Hand and shoe icon

Pisos e Paredes  
Floor and Walls / Sols et Murs  
Wandfliesen und Bodenfliesen / Pisos y Paredes

Color variation icon

Variação Média V2  
Average tone variation / Variation moyenne  
Durchschnittliche Tonhöhenchwankung  
Variación media de tono

Frost icon

Resistente ao gelo  
Frost resistant / Résistant au gel  
Frostbeständig / Resistente al hielo

20mm icon

Espessura  
Thickness / Épaisseur / Dicke / Grosor

Leveling icon

Recomendamos o uso de niveladores  
Recommended levelers / craisillons auto-nivellants conseillé  
Empfohlene Richtmaschinen / Niveladores recomendados

60x120

2 Pcs  
1,44 m<sup>2</sup>  
62,25 Kg

60x60

2 Pcs  
0,72 m<sup>2</sup>  
36 Kg

PAL

16 Cx  
23,04 m<sup>2</sup>  
1015 Kg

PAL

32 Pcs  
23,04 m<sup>2</sup>  
1152 Kg

Grelhas icon

Grelhas e outras peças especiais na  
Pág. 255 e 256

# Ark Silver

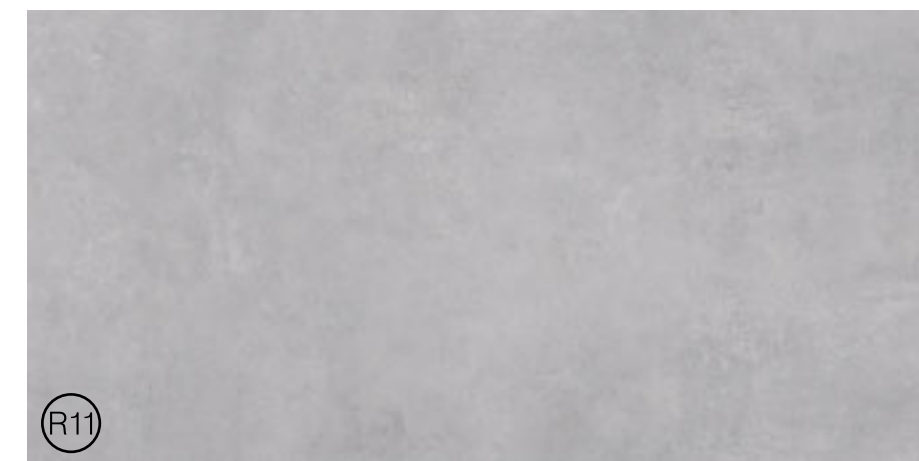

R11

ANTI SLIP FLOOR

60x120x2 PORCELÂNICO EXT

C58/82

Série: Ark Silver - ANTIDERRAPANTE

Ref.: RH601202SILESP



5 606779 196477

2cm



R11

ANTI SLIP FLOOR

60x60x2 PORCELÂNICO EXT

C50/70

Série: Ark Silver - ANTIDERRAPANTE

Ref.: RH60602SILESP



Pedestais na Pág. 261



Grelhas e outras peças especiais na Pág. 255 e 256



5 606779 196262

ESPESURADOS





R11

Resistência ao Deslizamento  
Slip resistance, Résistance à la glissance,  
Rutschkoeffizient, Resistencia al deslizamiento

MC

Massa colorada  
Color Body, Coloré dans la masse,  
Durchgefärbtes, Coloración en masa

RET

Retificado  
Rectified / Rectifié / Verarbeitet / Rectificado

Pisos e Paredes  
Floor and Walls / Sols et Murs  
Wandfliesen und Bodenfliesen / Pisos y Paredes

Variação Média V2  
Average tone variation / Variation moyenne  
Durchschnittliche Tonhöhenchwankung  
Variación media de tono

Resistente ao gelo  
Frost resistant / Résistant au gel  
Frostbeständig / Resistente al hielo

Espessura  
Thickness / Épaisseur / Dicke / Grosor

Recomendamos o uso de niveladores  
Recommended levelers / craisillons auto-nivellants conseillé  
Empfohlene Richtmaschinen / Niveladores recomendados

60x60  
2 Pcs  
0,72 m<sup>2</sup>  
36 Kg

PAL  
32 Pcs  
23,04 m<sup>2</sup>  
1.152 Kg

Grelhas e outras peças especiais na  
Pág. 255 e 256

# Luna

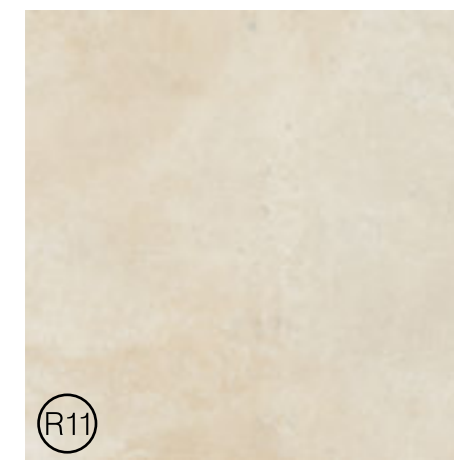

ANTI  
SLIP  
FLOOR

60x60x2 Porcelânico EXT

C50/70

Série: Luna Sand - ANTIDERRAPANTE

Ref.: RL60602SAEXT



5 606779 196385



ANTI  
SLIP  
FLOOR

60x60x2 Porcelânico EXT

C50/70

Série: Luna Cool Grey - ANTIDERRAPANTE

Ref.: RL60602COGREXT



5 606779 184917



ANTI  
SLIP  
FLOOR

60x60x2 Porcelânico EXT

C50/70

Série: Luna Ash - ANTIDERRAPANTE

Ref.: RL60602ASHEXT



5 606779 184900

ESPESURADOS





**ACESSÓRIOS**  
*Accessories / Accessoires*  
*Accesorios / Zubehör*



## Nichos Porcelânicos

Sob orçamento noutras referências



**Nicho Konkretus Cinza Mate** **N500/700**  
 Dim.: 36 x 66 x 10 cm / 15Kg / 0,05m<sup>3</sup>  
 Ref.: RN3666COCI



**Nicho Preto Mate** **N500/700**  
 Dim.: 36 x 66 x 10 cm / 15Kg / 0,05m<sup>3</sup>  
 Ref.: RN3666BLKMA



**Nicho Branco Brilho** **N500/700**  
 Dim.: 36 x 66 x 10 cm / 15Kg / 0,05m<sup>3</sup>  
 Ref.: RN3666WHPO



**Nicho Branco Mate** **N500/700**  
 Dim.: 36 x 66 x 10 cm / 15Kg / 0,05m<sup>3</sup>  
 Ref.: RN3666WHMA



**NEW +**



**Nicho Branco Mate** **N550/770**  
 Dim.: 36 x 96 x 10 cm / 15Kg / 0,05m<sup>3</sup>  
 Ref.: RN3696ORB



**NEW +**

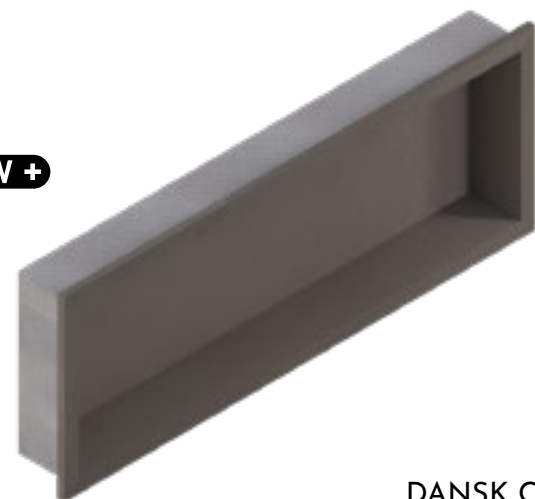

**Nicho Konkretus Cinza Mate** **N550/770**  
 Dim.: 36 x 96 x 10 cm / 15Kg / 0,05m<sup>3</sup>  
 Ref.: RN3696DCG



## Cabides Porcelânicos

Sob orçamento noutras referências



RAC9CMAR  
N75/105



RAC7CMAR  
N68/95



RAC5CMAR  
N60/84



BRANCO MATE E ARGENTO MATE

**Cabide Porcelânico PUNTO**  
 Dim.: Ø5cm N60/84 • Ø7cm N68/95 • Ø9cm N75/105  
 Ref.: RAC5CMOFFW / RAC7CMOFFW/ RAC9CMOFFW

## Mesas Porcelânicas

Sob orçamento noutras referências



**+ NEW**

TAMPO EM PORCELÂNICO

O design intemporal da Nordik Table tem como protagonista a superfície da madeira Nordik Wood. Uma solução que combina o toque e aconchego da madeira à funcionalidade da lâmina de porcelanato. Opção que pode atender ambientes internos, externos, domésticos e comerciais.

MESA NORDIK - M

Dim.: 250 x 110 x 75 cm / 213Kg / 3,86m<sup>3</sup>  
 Ref.: RNT250110

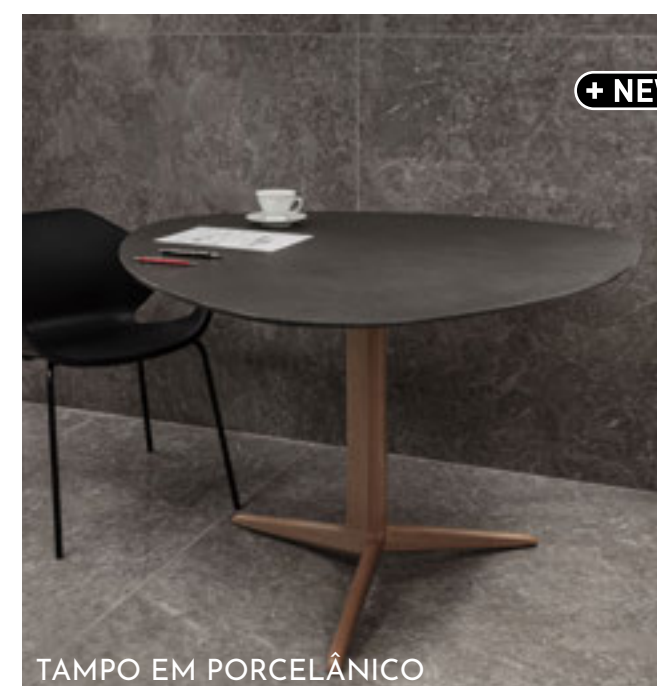

**+ NEW**

TAMPO EM PORCELÂNICO

Mesa de apoio TREE - Mate  
 Dim.: Ø 115 x 72cm / 50Kg / 1,35m<sup>3</sup>  
 Ref.: RTW115DACEGRA



**+ NEW**

TAMPO EM PORCELÂNICO

Mesa de apoio HARPA - Mate  
 Dim.: 56,4 x 31,4 x 66,7cm / 24Kg / 0,3m<sup>3</sup>  
 Ref.: RTHARP





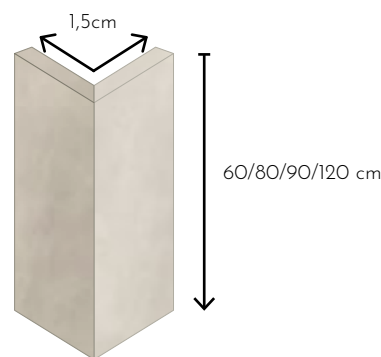
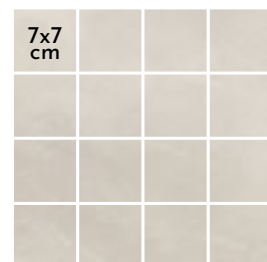
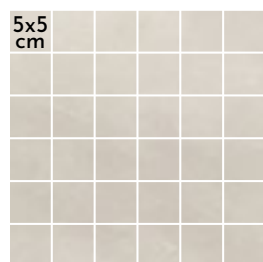

Pastilha em rede - junta de 2mm  
mesh mosaic / mosaïque collés sur trame  
mosaik auf netz geklebt / mosaico en malla

30 x 30 cm / 5x5cm C140/196 unit  
30 x 30 cm / 7x7cm C130/182 unit

Perfil cerâmico para acabamento de esquina  
Finishing ceramic profile / Profil en céramique pour finition  
Keramisches Profil zum Schlichten / Perfil cerámico para el acabado

1,5 x 60 cm C25/35 unit  
1,5 x 80 cm C30/42 unit  
1,5 x 90 cm C35/49 unit  
1,5 x 120 cm C50/70 unit

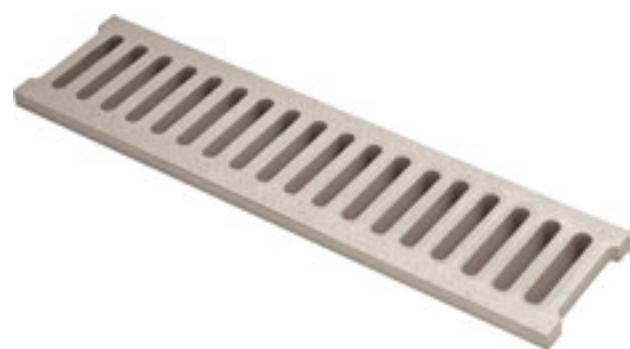

Grelha de escoamento  
Overflow Grille / Grille / Überlauf / Rejilla

15 x 60 x 2 cm C75/105 unit



Grelha de escoamento canto  
Overflow corner Grille / Grille d'angle  
Überlauf Ecke / Rejilla de esquina

15 x 60 x 2 cm C150/210 unit



Grelha de escoamento  
Overflow Grille / Grille / Überlauf / Rejilla

30 x 60 x 2 cm C90/126 unit

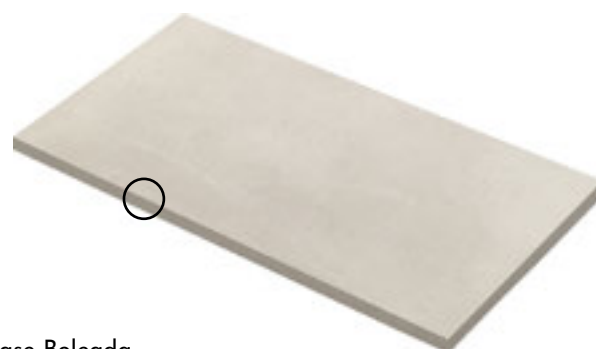

Base Boleada  
Rounded Base / Margelle Arrondie  
Stufenplatte Abgerundet

30 x 60 x 2 cm C45/63 unit

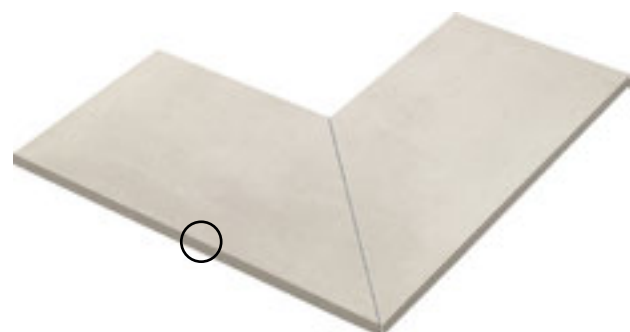

Canto Exterior boleado  
Bullnose outer corner / margelles bord extérieur arrondi  
Abgerundete aussenecke (Gärung)

30 x 60 x 2 cm C110/154 unit



Canto Interior boleado  
Bullnose inner corner / margelles bord intérieur arrondi  
Abgerundete innenecke (Gärung)

30 x 60 x 2 cm C110/154 unit

# Peças Especiais Polish & Mate



Degrau Simples Boleado  
Step / Marche / Treppenstufe / Pazo

30 x 60 cm C30/42 unit  
30 x 80 cm C40/56 unit  
30 x 90 cm C45/63 unit  
30 x 120 cm C60/84 unit



Degrau Técnico  
Step / Marche / Treppenstufe / Pazo

30 x 60 cm C70/98 unit  
30 x 80 cm C120/168 unit  
30 x 90 cm C135/189 unit  
30 x 120 cm C160/224 unit



Rodapé Normal  
Skirting Board / Plinthe / Sockelleiste / Rodapié

8 x 60 cm C10/14 unit  
8 x 80 cm C15/21 unit  
8 x 90 cm C15/21 unit  
8 x 120 cm C20/28 unit



Rodapé Alto Boleado  
Skirting Board / Plinthe / Sockelleiste / Rodapié

20 x 60 cm C25/35 unit  
20 x 80 cm C35/49 unit  
20 x 90 cm C40/56 unit  
20 x 120 cm C50/70 unit



IDEAL PARA PROTEÇÃO DE PISOS EM OBRAS EM CURSO

## RubiProtect

Proteção de pisos  
Espuma EPE com película em PP Impermeável



Produto: RUBIPROTECT - PV1.5/2.1 - m<sup>2</sup>  
Formato: 1 x 10 m - 10m<sup>2</sup> / 3Kg  
Espessura: 1.5mm  
Ref: RTPROFLOOR











5 606779 199805



# Perfis para cerâmica

MUITO MAIS QUE ACABAMENTOS, SÃO PEÇAS DE DECORAÇÃO



-  Ouro Mate  
Ref.: RALAR12OMT
-  Ouro Brilho  
Ref.: RALAR12OC
-  Branco Mate  
Ref.: RAOR12ABLAMT
-  Branco Brilho  
Ref.: RALAR12BLA
-  Preto Mate  
Ref.: RALAR12NHMT
-  Preto Brilho  
Ref.: RALAR12NB
-  Alumínio Mate  
Ref.: RALAR12PMT
-  Alumínio Brilho  
Ref.: RALAR12PB

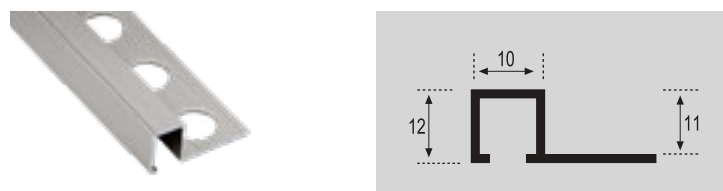

**Perfil Rectangular** A7/9.8

Série: Perfil Alumínio - 10x12mm / 2,60m



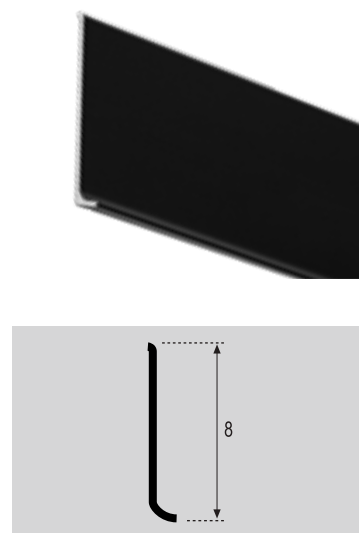

-  Alumínio Mate  
Ref.: RA00OR80PMT
-  Branco Brilho  
Ref.: RA00OR80BRAMT
-  Preto Mate  
Ref.: RA00OR80NMT
-  Ouro Mate  
Ref.: RA00OR80OMT



**Rodapé 8cm** A22/31

Série: Perfil Alumínio - 8cm / 2,50m





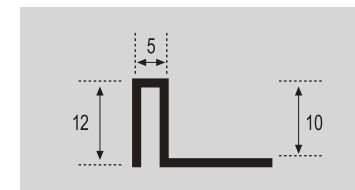



-  Alumínio Brilho  
Ref.: RALA125PB
-  Alumínio Mate  
Ref.: RALA125PMT



**Perfil Retangular** A7/9.8







Série: Perfil Alumínio - 5mm / 2,60m

-  Ouro Brilho  
Ref.: RAOAL10OC
-  Bronze Mate  
Ref.: RAA105BBROB
-  Alumínio Brilho  
Ref.: RAOAL10PB
-  Alumínio Mate  
Ref.: RAOAL10PMT
-  Preto Brilho  
Ref.: RAOAL10NB
-  Preto Mate  
Ref.: RAOAL10NEMT
-  Branco Brilho  
Ref.: RAOAL10BLA



**Perfil Redondo** A7/9.8

Série: Perfil Alumínio - 10mm / 2,60m

-  Alumínio Brilho  
Ref.: RAOAL08PB
-  Alumínio Mate  
Ref.: RAOAL08PMT
-  Branco Brilho  
Ref.: RAOAL08BLA
-  Bronze Mate  
Ref.: RAAL08BROMT
-  Preto Brilho  
Ref.: RAOAL08NB
-  Preto Mate  
Ref.: RAOAL08NEMT

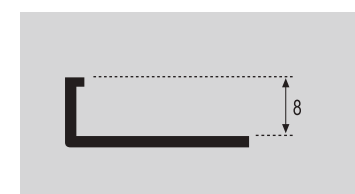

**Perfil Recto** A7/9.8

Série: Perfil Alumínio - 8mm / 2,60m







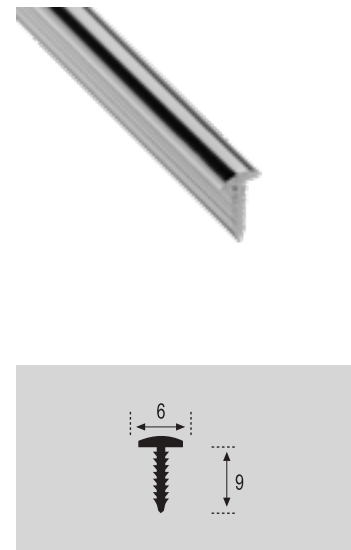

-  Alumínio Brilho  
Ref.: RAOLA06PB
-  Alumínio Mate  
Ref.: RAOLA06PMT
-  Ouro Brilho  
Ref.: RAOLA06OO
-  Ouro Escovado  
Ref.: RAOLA06OLMT
-  Bronze Brilho  
Ref.: RAOLA06BROB



**Perfil T Boleado** A5/7

Série: Perfil Boleado - 6mm / 2,50m



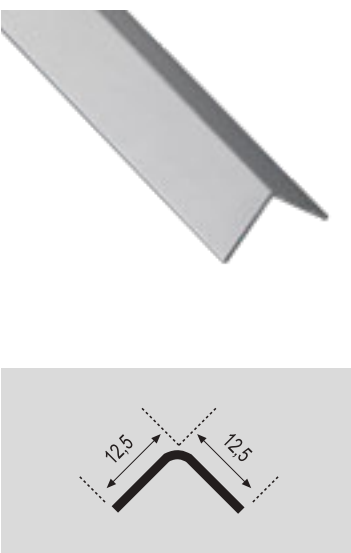

-  Alumínio Brilho  
Ref.: RAOAA12PB
-  Alumínio Mate  
Ref.: RAOAA12PMT



**Perfil Ângulo Quadrado** A6/8.4

Série: Perfil Alumínio - 12,5mm / 2,50m



-  Ouro Mate  
Ref.: RAOA105OMT
-  Ouro Brilho  
Ref.: RAOA105OC
-  Branco Mate  
Ref.: RAA105ABLMT
-  Branco Brilho  
Ref.: RAOA105BLA
-  Bronze Mate  
Ref.: RAA105BROM
-  Bronze Brilho  
Ref.: RAA105BROB
-  Preto Mate  
Ref.: RAOA105NHMT
-  Alumínio Brilho  
Ref.: RAOA105PB
-  Alumínio Mate  
Ref.: RAOA105PMT

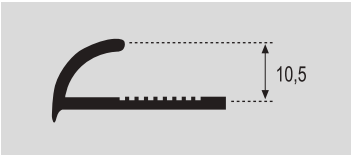

**Perfil Redondo** A7/9.8

Série: Perfil Alumínio - 10,5mm / 2,60m

# Sistema de Nivelamento

tile leveling system | système de nivellement de carreaux | Fliesenausgleichssystem | sistema de nivelación



 REUTILIZÁVEL

ROSCA - 100 Pcs/Saco

C9/13

Série: Twister

Ref.: RATWISTERROSC



PARAFUSO - 250 Pcs/Saco

C12/17

Série: Twister

Ref.: RATWISTERPAR



VEJA O VÍDEO DE INSTALAÇÃO  
CHECK THE INSTRUCTIONS VIDEO  
REGARDEZ LA VIDEO D'INSTRUCTION  
VEA EL VÍDEO DE INSTRUCCIONES



● Ref.: RATWISTERROSC - Reutilizavel



○ Ref.: RATWISTERPAR - 1mm

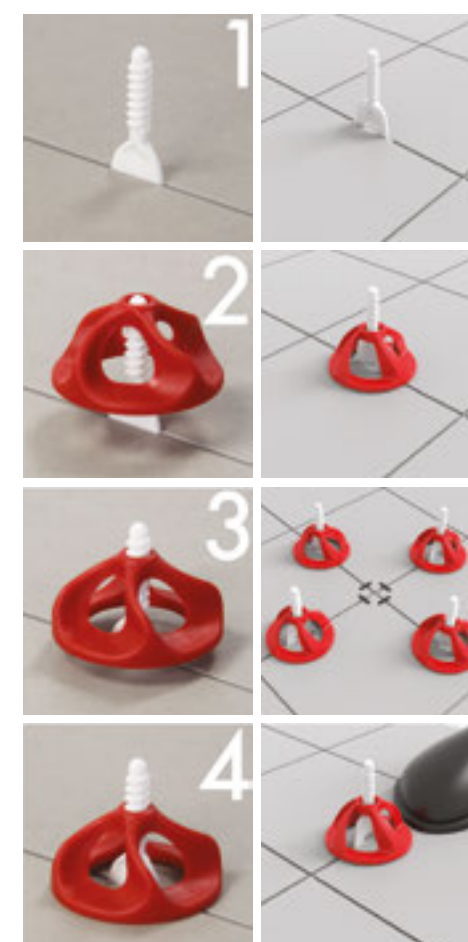

A cm	10	15	20	25	30	33	40	45	50	60	80	90	100	120	B cm
10	200														
15	133	89													
20	100	67	50												
25	80	53	40	32											
30	30	30	30	30	30										
33	91	61	45	36	40	37									
40	75	50	37	30	33	30	25								
45	67	44	33	27	30	27	22	20							
50	60	40	30	24	27	24	20	18	16						
60	50	33	25	20	22	20	17	15	13	11					
80	50	33	25	20	21	19	16	14	12	10	9				
90	44	30	22	18	19	17	14	12	11	9	8	7			
100	50	33	25	20	20	18	15	13	12	10	9	8	8		
120	42	28	21	17	17	15	13	11	10	8	7	6	7	6	

A = 60 cm  
B = 60 cm  
**11 Pcs/m<sup>2</sup>**









**PEDRAS NATURAIS**  
Natural Stones / Pierres Naturelles  
Natursteine / Piedras Naturales





Pedra Natural  
Natural Stone / Pierre naturelle  
Naturstein / Piedra natural



Mate  
Matt / Mat / Mattes / Mate



Interiores e Exteriores  
Indoors and outdoors / Intérieurs et extérieurs  
Drinnen und draußen / Interior y exterior



Variação Média V3  
Average tone variation / Variation moyenne  
Durchschnittliche Tonhöhenchwankung  
Variación media de tono



Resistente ao gelo  
Frost resistant / Résistant au gel  
Frostbeständig / Resistente a las heladas



Espessura  
Thickness / Epaisseur / Dicke / Grosor



Recomendamos o uso de impermeabilizantes  
Water repellent recommend / hydrofuge recommande  
Wasserabweisend empfehlen  
Recomendamos un Repelente de agua



Dupla colagem  
Double glue / Double encollage  
Doppelkleben / Doble encolado



PCS  
7 Pcs  
0,63 m<sup>2</sup>  
29 Kg



PAL  
48 Cx  
30,24 m<sup>2</sup>  
1.407 Kg

# Ambar



15x60 - 10/20mm ARENITO

ST44/62

Série: **Ambar**

Ref.: RST1560AMB



5 606779 250780

PEDRA  
NATURAL

# Olivenite



15x60 - 10/20mm ARDOSIA

ST40/56

Série: **Olivenite**

Ref.: RST1560OLV



5 606779 250797





Pedra Natural  
Natural Stone / Pierre naturelle  
Naturstein / Piedra natural



Cristalino  
Crystalline / Cristalline / Kristallin / Cristalino



Interiores e Exteriores  
Indoors and outdoors / Intérieurs et extérieurs  
Draußen und drinnen / Interior y exterior



Variação Média V3  
Average tone variation / Variation moyenne  
Durchschnittliche Tonhöhenchwankung  
Variación media de tono



Resistente ao gelo  
Frost resistant / Résistant au gel  
Frostbeständig / Resistente a las heladas



Espessura  
Thickness / Epaisseur / Dicke / Grosor



Recomendamos o uso de impermeabilizantes  
Water repellent recommend / hydrofuge recommande  
Wasserabweisend empfehlen  
Recomendamos un Repelente de agua



Dupla colagem  
Double glue / Double encollage  
Doppelkleben / Doble encolado



PCS  
7 Pcs  
0,63 m<sup>2</sup>  
20 Kg



PAL  
48 Cx  
30,24 m<sup>2</sup>  
1.000 Kg

# Roma Silver



15x60 - 10/20mm QUARTZITE

ST100/140

Série: **Roma Silver**

Ref.: RSTLAJ1308LRSIL



5 606779 202062

# Roma Gold



15x60 - 10/20mm QUARTZITE

ST80/112

Série: **Roma Gold**

Ref.: RSTLAJ1308LRGOLD



5 606779 202079

PEDRA  
NATURAL





Pedra Natural  
Natural Stone / Pierre naturelle  
Naturstein / Piedra natural



Mate  
Matt / Mat / Mattes / Mate



Interiores e Exteriores  
Indoors and outdoors / Intérieurs et extérieurs  
Drinnen und draußen / Interior y exterior



Variação Média V3  
Average tone variation / Variation moyenne  
Durchschnittliche Tonhöenschwankung  
Variación media de tono



Resistente ao gelo  
Frost resistant / Résistant au gel  
Frostbeständig / Resistente a las heladas



Espessura  
Thickness / Épaisseur / Dicke / Grosor



Recomendamos o uso de impermeabilizantes  
Water repellent recommend / hydrofuge recommande  
Wasserabweisend empfehlen  
Recomendamos un Repelente de agua



Dupla colagem  
Double glue / Double encollage  
Doppelkleben / Doble encolado



**PCS**  
6 Pcs  
0,54 m<sup>2</sup>  
22.60 Kg



**PAL**  
48 Cx  
25,92 m<sup>2</sup>  
1.085 Kg

# Milano Black



15x60 - 10/20mm CALCÁRIO

**ST85/119**

Série: **Milano Black**

Ref.: RST1560MLNBLCK



5 606779 193957

# Milano



15x60 - 10/20mm CALCÁRIO

**ST80/112**

Série: **Milano**

Ref.: RST1560MLN



5 606779 193940

PEDRA  
NATURAL





Pedra Natural  
Natural Stone / Pierre naturelle  
Naturstein / Piedra natural



Mate  
Matt / Mat / Mattes / Mate



Interiores e Exteriores  
Indoors and outdoors / Intérieurs et extérieurs  
Dinnen und draußen / Interior y exterior



Variação Média V3  
Average tone variation / Variation moyenne  
Durchschnittliche Tonhöhenchwankung  
Variación media de tono



Resistente ao gelo  
Frost resistant / Résistant au gel  
Frostbeständig / Resistente a las heladas



Espessura  
Thickness / Epaisseur / Dicke / Grosor



Recomendamos o uso de impermeabilizantes  
Water repellent recommend / hydrofuge recommande  
Wasserabweisend empfehlen  
Recomendamos un Repelente de agua



Dupla colagem  
Double glue / Double encollage  
Doppelkleben / Doble encolado



PCS  
5 Pcs  
0,45 m<sup>2</sup>  
18,75 Kg



PAL  
48 Cx  
21,60 m<sup>2</sup>  
945 Kg

## Tivoli White



15x67,5 - 10/17mm TRAVERTINO

ST70/98

Série: **Tivoli White**

Ref.: RST1560TVLW



5 606779 193681

## Tivoli Gris



15x67,5 - 10/17mm TRAVERTINO

ST70/98

Série: **Tivoli Gris**

Ref.: RST1560TVLGR



5 606779 193698





Pedra Natural  
Natural Stone / Pierre naturelle  
Naturstein / Piedra natural



Cristalino  
Crystalline / Cristalline / Kristallin / Cristalino



Interiores e Exteriores  
Indoors and outdoors / Intérieurs et extérieurs  
Drinnen und draußen / Interior y exterior



Variação Média V3  
Average tone variation / Variation moyenne  
Durchschnittliche Tonhöfenschwankung  
Variación media de tono



Resistente ao gelo  
Frost resistant / Résistant au gel  
Frostbeständig / Resistente a las heladas

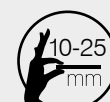

Espessura  
Thickness / Epaisseur / Dicke / Grosor



Recomendamos o uso de impermeabilizantes  
Water repellent recommend / hydrofuge recommande  
Wasserabweisend empfehlen  
Recomendamos un Repelente de agua



Dupla colagem  
Double glue / Double encollage  
Doppelkleben / Doble encolado



**LISA**  
8 Pcs  
0,66 m<sup>2</sup>  
19,50 Kg



**TICIANO**  
8 Pcs  
0,72 m<sup>2</sup>  
23 Kg



**PAL**  
48 Cx  
31,68 m<sup>2</sup>  
936 Kg



**PAL**  
48 Cx  
34,56 m<sup>2</sup>  
1100 Kg

# Lisa



15x60 - 10/15mm MÁRMORE

**ST100/140**

Série: **Lisa**

Ref.: RS0516C



5 1606779 169976

# Ticiano



15x60 - 15/25mm MÁRMORE

**ST70/98**

Série: **Ticiano White**

Ref.: RJVS504E



5 1606779 161246



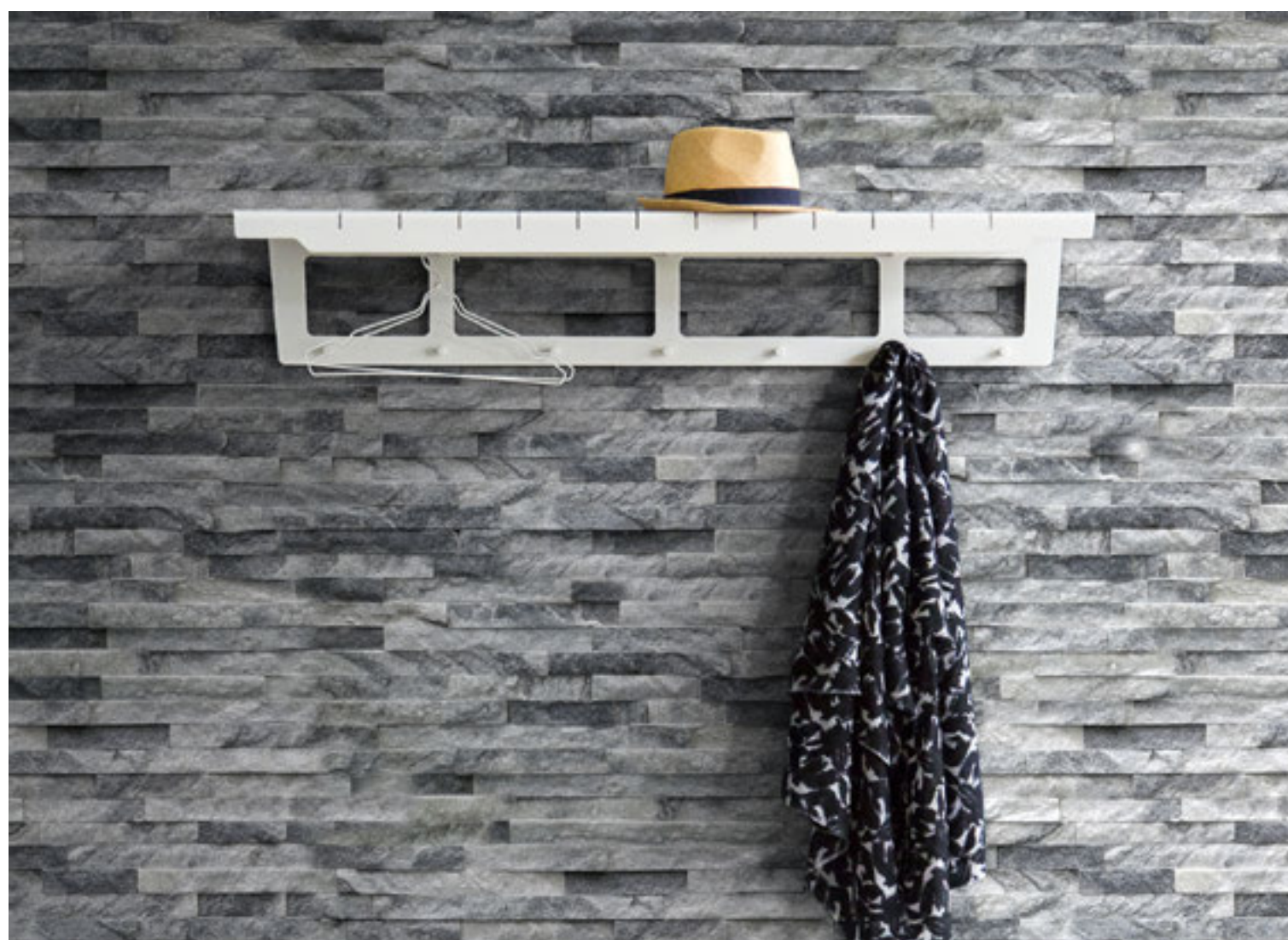

Pedra Natural  
Natural Stone / Pierre naturelle  
Naturstein / Piedra natural



Cristalino  
Crystalline / Cristalline / Kristallin / Cristalino



Interiores e Exteriores  
Indoors and outdoors / Intérieurs et extérieurs  
Draußen und drinnen / Interior y exterior



Variação Média V3  
Average tone variation / Variation moyenne  
Durchschnittliche Tonhöhenchwankung  
Variación media de tono



Resistente ao gelo  
Frost resistant / Résistant au gel  
Frostbeständig / Resistente a las heladas

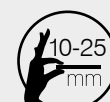

Espessura  
Thickness / Épaisseur / Dicke / Grosor



Recomendamos o uso de impermeabilizantes  
Water repellent recommend / hydrofuge recommande  
Wasserabweisend empfehlen  
Recomendamos un Repelente de agua



Dupla colagem  
Double glue / Double encollage  
Doppelkleben / Doble encolado

**GREY T.**  
6 Pcs  
0,54 m<sup>2</sup>  
17,60 Kg

**VITTORIA**  
8 Pcs  
0,72 m<sup>2</sup>  
23 Kg

**PAL**  
48 Cx  
25,92 m<sup>2</sup>  
1.100 Kg

**PAL**  
48 Cx  
34,56 m<sup>2</sup>  
1.100 Kg

# Grey Tiger



15x60 - 15/25mm MÁRMORE

ST90/126

Série: **Grey Tiger**

Ref.: RLAJ1308JX



5 606779 193919

# Vittoria



15x60 - 10/20mm MÁRMORE

ST65/91

Série: **Vittoria**

Ref.: RLAJ1308SDB



5 606779 179975





Pedra Natural  
Natural Stone / Pierre naturelle  
Naturstein / Piedra natural



Cristalino  
Crystalline / Cristalline / Kristallin / Cristalino



Interiores e Exteriores  
Indoors and outdoors / Intérieurs et extérieurs  
Drinnen und draußen / Interior y exterior



Variação Média V3  
Average tone variation / Variation moyenne  
Durchschnittliche Tonhöhenchwankung  
Variación media de tono



Resistente ao gelo  
Frost resistant / Résistant au gel  
Frostbeständig / Resistente a las heladas



Espessura  
Thickness / Epaisseur / Dicke / Grosor



Recomendamos o uso de impermeabilizantes  
Water repellent recommend / hydrofuge recommandé  
Wasserabweisend empfehlen  
Recomendamos un Repelente de agua



Dupla colagem  
Double glue / Double encollage  
Doppelkleben / Doble encolado



**NOVARA**  
8 Pcs  
0,72 m<sup>2</sup>  
23 Kg



**CORREGIO**  
5 Pcs  
0,45 m<sup>2</sup>  
19,17 Kg



**PAL**  
24 Cx  
17,28 m<sup>2</sup>  
620 Kg



**PAL**  
60 Cx  
27 m<sup>2</sup>  
1200 Kg

# Novara



15,5x65 - 10/20mm ARDÓSIA

**ST44/62**

Série: **Novara Cinza**

Ref.: RST1560NVR



5 606779 193223



# Corregio



15x60 - 20/40mm ARDÓSIA - mate

**ST100/140**

Série: **Corregio**

Ref.: RJZS0510C



5 606779 161314





Pedra Natural  
Natural Stone / Pierre naturelle  
Naturstein / Piedra natural



Mate  
Matt / Mat / Mattes / Mate



Interiores e Exteriores  
Indoors and outdoors / Intérieurs et extérieurs  
Drinnen und draußen / Interior y exterior



Variação Média V3  
Average tone variation / Variation moyenne  
Durchschnittliche Tonhöhenchwankung  
Variación media de tono



Resistente ao gelo  
Frost resistant / Résistant au gel  
Frostbeständig / Resistente a las heladas



Espessura  
Thickness / Epaisseur / Dicke / Grosor



Recomendamos o uso de impermeabilizantes  
Water repellent recommend / hydrologie recommande  
Wasserabweisend empfehlen  
Recomendamos un Repelente de agua



Dupla colagem  
Double glue / Double encollage  
Doppelkleben / Doble encolado



**DACCA**  
5 Pcs  
0,45 m<sup>2</sup>  
16,80 Kg



**FERRARA**  
8 Pcs  
0,72 m<sup>2</sup>  
21,09 Kg



**PAL**  
64 Cx  
28,80 m<sup>2</sup>  
1,125 Kg



**PAL**  
48 Cx  
34,56 m<sup>2</sup>  
1,062 Kg

# Dacca



15x60 - 10/15mm ARDÓSIA

ST110/154

Série: **Dacca**

Ref.: RS0516B



5 1606779 169969

# Ferrara



15x60 - 10/15mm ARDÓSIA

ST44/62

Série: **Ferrara**

Ref.: RLAJ106XZ



5 1606779 162014





Pedra Natural  
Natural Stone / Pierre naturelle  
Naturstein / Piedra natural



Cristalino  
Crystalline / Cristalline / Kristallin / Cristalino



Interiores e Exteriores  
Indoors and outdoors / Intérieurs et extérieurs  
Drinnen und draußen / Interior y exterior



Variação Média V3  
Average tone variation / Variation moyenne  
Durchschnittliche Tonhöhenchwankung  
Variación media de tono



Resistente ao gelo  
Frost resistant / Résistant au gel  
Frostbeständig / Resistente a las heladas



Espessura  
Thickness / Epaisseur / Dicke / Grosor



Recomendamos o uso de impermeabilizantes  
Water repellent recommend / hydrofuge recommande  
Wasserabweisend empfehlen  
Recomendamos un Repelente de agua



Dupla colagem  
Double glue / Double encollage  
Doppelkleben / Doble encolado

AOSTA	CARBONITE
7 Pcs	10 Pcs
0,578 m <sup>2</sup>	0,45 m <sup>2</sup>
20,41 Kg	19,50 Kg

PAL	PAL
60 Cx	126 Cx
34,65 m <sup>2</sup>	56,70 m <sup>2</sup>
1.275 Kg	1.445 Kg

# Aosta



15x60 - 15/25mm QUARTZITE

ST75/105

Série: **Aosta**

Ref.: RC1308



5 606779 154910

# Carbonite



10x45 - 8/13mm QUARTZITE

ST65/91

Série: **Carbonite - Encaixe**

Ref.: RST1045CAR



5 606779 196446



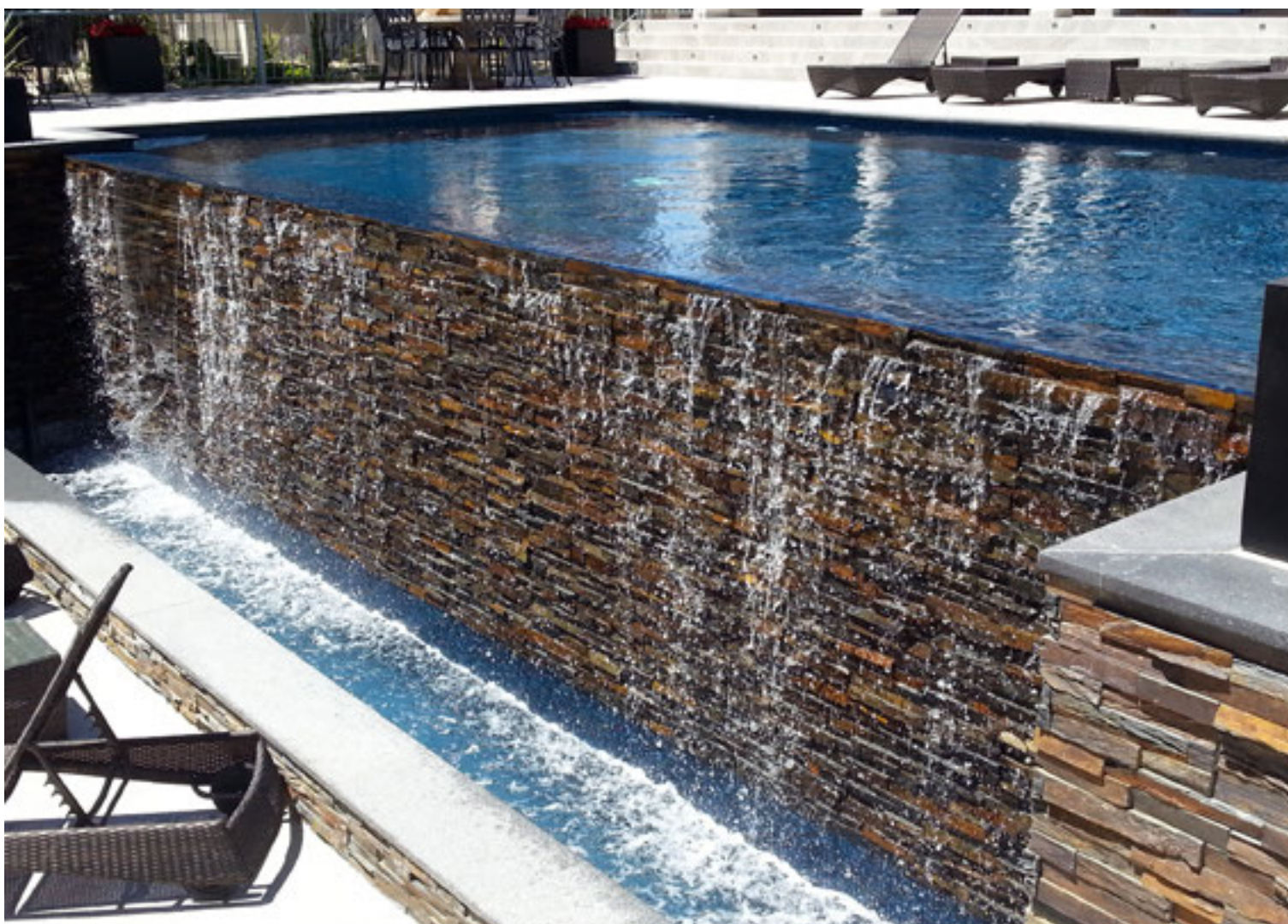

Pedra Natural  
Natural Stone / Pierre naturelle  
Naturstein / Piedra natural



Polido  
Polish / Poli / Poliert / Pulido



Interiores e Exteriores  
Indoors and outdoors / Intérieurs et extérieurs  
Draußen und drinnen / Interior y exterior



Variação Média V3  
Average tone variation / Variation moyenne  
Durchschnittliche Tonhöhenchwankung  
Variación media de tono



Resistente ao gelo  
Frost resistant / Résistant au gel  
Frostbeständig / Resistente a las heladas

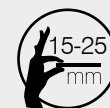

Espessura  
Thickness / Épaisseur / Dicke / Grosor



Recomendamos o uso de impermeabilizantes  
Water repellent recommend / hydrofuge recommande  
Wasserabweisend empfehlen  
Recomendamos un Repelente de agua



Dupla colagem  
Double glue / Double encollage  
Doppelkleben / Doble encolado



6 Pcs  
0,54 m<sup>2</sup>  
17,54 Kg



48 Cx  
25,92 m<sup>2</sup>  
1.100 Kg

## Marquina Polish



15x60 - 15/25mm MÁRMORE

ST110/154

Série: **Marquina Polish - Polido**

Ref.: RLAJ1308HBG



5 606779 193902

## Lippo



15x60 - 20/35mm ARDÓSIA

ST100/140

Série: **Lippo**

Ref.: RJZS0509B



5 606779 161291



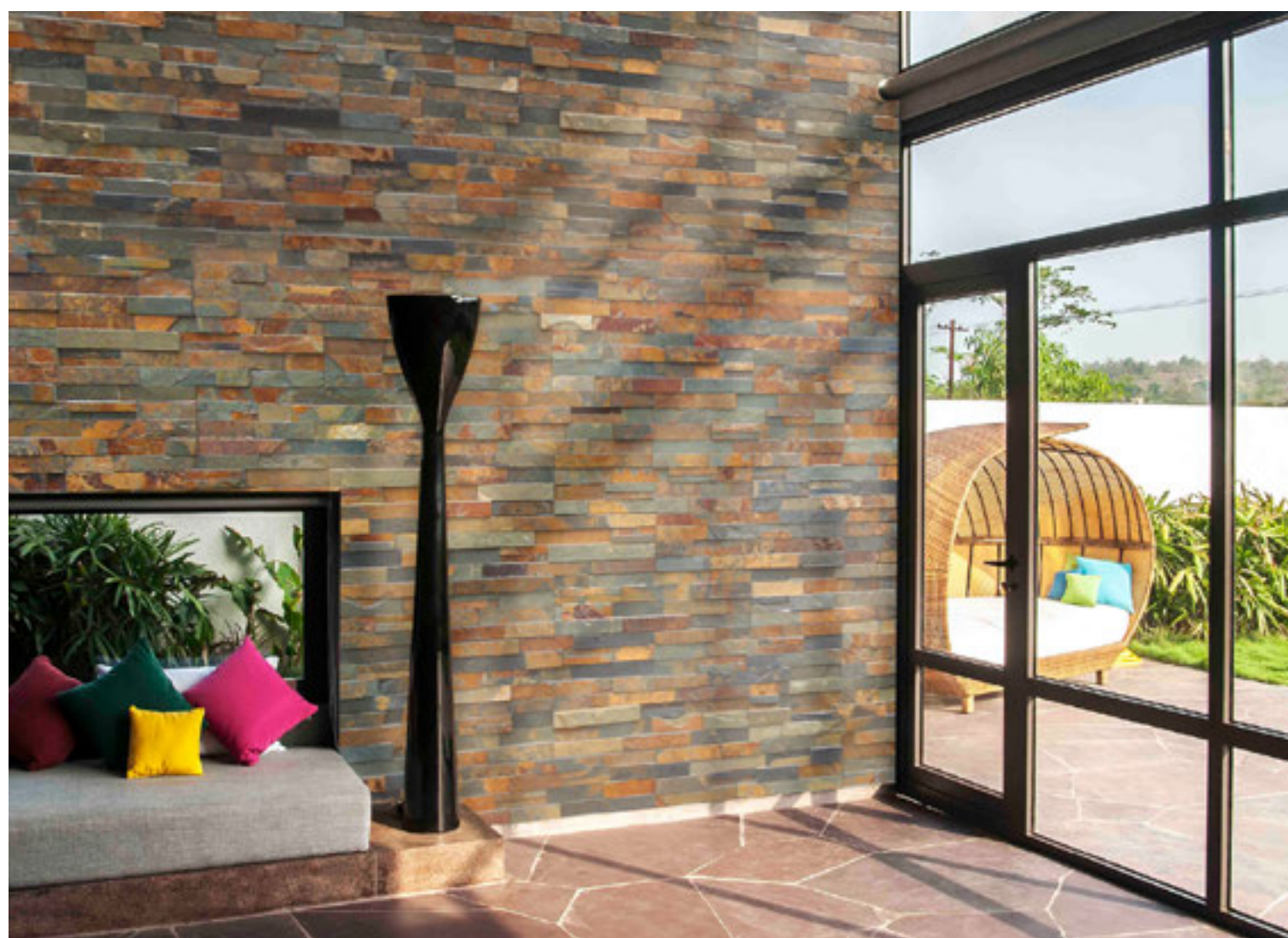

Pedra Natural  
Natural Stone / Pierre naturelle  
Naturstein / Piedra natural



Cristalino  
Crystalline / Cristalline / Kristallin / Cristalino



Interiores e Exteriores  
Indoors and outdoors / Intérieurs et extérieurs  
Drinnen und draußen / Interior y exterior



Variação Média V3  
Average tone variation / Variation moyenne  
Durchschnittliche Tonhöhenchwankung  
Variación media de tono



Resistente ao gelo  
Frost resistant / Résistant au gel  
Frostbeständig / Resistente a las heladas



Espessura  
Thickness / Epaisseur / Dicke / Grosor



Recomendamos o uso de impermeabilizantes  
Water repellent recommend / hydrofuge recommande  
Wasserabweisend empfehlen  
Recomendamos un Repelente de agua



Dupla colagem  
Double glue / Double encollage  
Doppelkleben / Doble encolado

**LATINA**  
8 Pcs  
0,72 m<sup>2</sup>  
22,39 Kg

**ENNA**  
8 Pcs  
0,72 m<sup>2</sup>  
21,09 Kg

**PAL**  
48 Cx  
34,56 m<sup>2</sup>  
1.125 Kg

**PAL**  
48 Cx  
34,56 m<sup>2</sup>  
1.062 Kg

# Latina



15x60 - 10/20mm QUARTZITE

**ST65/91**

Série: **Latina**

Ref.: RLAJ1806AB



5 606779 179982

# Enna



15x60 - 10/15mm ARDÓSIA

**ST44/62**

Série: **Enna**

Ref.: RC11



5 606779 154767





Pedra Natural  
Natural Stone / Pierre naturelle  
Naturstein / Piedra natural



Mate  
Matt / Mat / Mattes / Mate



Interiores e Exteriores  
Indoors and outdoors / Intérieurs et extérieurs  
Drinnen und draußen / Interior y exterior



Variação Média V3  
Average tone variation / Variation moyenne  
Durchschnittliche Tonhöhenchwankung  
Variación media de tono



Resistente ao gelo  
Frost resistant / Résistant au gel  
Frostbeständig / Resistente a las heladas

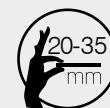

Espessura  
Thickness / Épaisseur / Dicke / Grosor



Recomendamos o uso de impermeabilizantes  
Water repellent recommend / hydrofuge recommande  
Wasserabweisend empfehlen  
Recomendamos un Repelente de agua



Dupla colagem  
Double glue / Double encollage  
Doppelkleben / Doble encolado



**ASTI**  
7 Pcs  
0,63 m<sup>2</sup>  
30,48 Kg



**VERONESE**  
5 Pcs  
0,45 m<sup>2</sup>  
28,58 Kg



**PAL**  
48 Cx  
30,24 m<sup>2</sup>  
1.475 Kg



**PAL**  
36 Cx  
16,20 m<sup>2</sup>  
1.200 Kg

# Asti



15x60 - 20/35mm TRAVERTINO

**ST95/133**

Série: **Asti**

Ref.: RLAJ1807SB



5 606779 179968

# Veronese



15x60 - 25/35mm QUARTZITE

**ST120/168**

Série: **Veronese**

Ref.: RJZS0511B



5 606779 161321





Pedra Natural  
Natural Stone / Pierre naturelle  
Naturstein / Piedra natural



Cristalino  
Crystalline / Cristalline / Kristallin / Cristalino



Interiores e Exteriores  
Indoors and outdoors / Intérieurs et extérieurs  
Drinnen und draußen / Interior y exterior



Variação Média V3  
Average tone variation / Variation moyenne  
Durchschnittliche Tonhöhenchwankung  
Variación media de tono



Resistente ao gelo  
Frost resistant / Résistant au gel  
Frostbeständig / Resistente a las heladas



Espessura  
Thickness / Epaisseur / Dicke / Grosor



Recomendamos o uso de impermeabilizantes  
Water repellent recommend / hydrofuge recommande  
Wasserabweisend empfehlen  
Recomendamos un Repelente de agua



Dupla colagem  
Double glue / Double encollage  
Doppelkleben / Doble encolado



**OMAN**  
8 Pcs  
0,72 m<sup>2</sup>  
22,86 Kg



**NAIC**  
8 Pcs  
0,66 m<sup>2</sup>  
25,92 Kg



**PAL**  
48 Cx  
34,56 m<sup>2</sup>  
1200 Kg



**PAL**  
48 Cx  
31,68 m<sup>2</sup>  
1155 Kg

# Oman



15x60 - 10/20mm QUARTZITE

**ST65/91**

Série: **Oman**

Ref.: RS0507A



5 606779 169921

# Naic



15x60 - 10/25mm MÁRMORE \*

**ST70/98**

Série: **Naic**

Ref.: R1308SPB



5 606779 148162

\* Com cristais acobreados





Pedra Natural  
Natural Stone / Pierre naturelle  
Naturstein / Piedra natural



Mate  
Matt / Mat / Mattes / Mate



Interiores e Exteriores  
Indoors and outdoors / Intérieurs et extérieurs  
Drinnen und draußen / Interior y exterior



Variação Média V3  
Average tone variation / Variation moyenne  
Durchschnittliche Tonhöhenchwankung  
Variación media de tono



Resistente ao gelo  
Frost resistant / Résistant au gel  
Frostbeständig / Resistente a las heladas



Espessura  
Thickness / Épaisseur / Dicke / Grosor



Recomendamos o uso de impermeabilizantes  
Water repellent recommend / hydrologie recommand  
Wasserabweisend empfehlen  
Recomendamos un Repelente de agua



Dupla colagem  
Double glue / Double encollage  
Doppelkleben / Doble encolado



**30x60**  
5 Pcs  
0,9 m<sup>2</sup>  
31 Kg



**40x60**  
4 Pcs  
0,96 m<sup>2</sup>  
31 Kg



**PAL**  
36 Cx  
32,40 m<sup>2</sup>  
1.100 Kg



**PAL**  
36 Cx  
32,40 m<sup>2</sup>  
1.100 Kg

## Ardósia Black

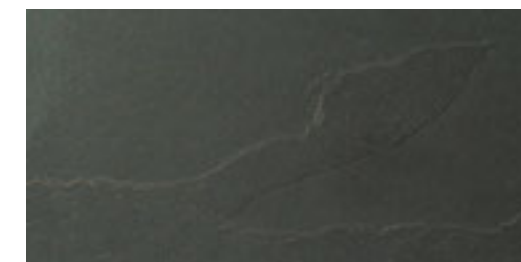

30x60 - 12mm ARDÓSIA

**ST40/56**

Série: **Black**

Ref.: RJS101



## Ardósia Multicolor



30x60 - 12mm ARDÓSIA

**ST40/56**

Série: **Multicolor**

Ref.: RJS102Y

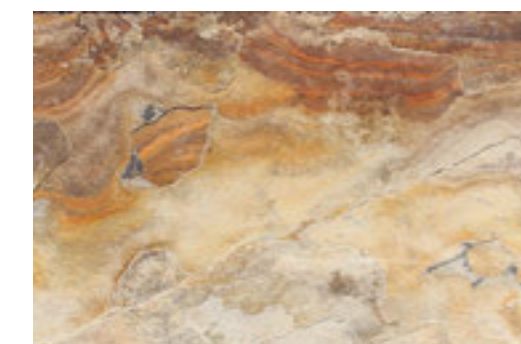

40x60 - 14/16mm ARDÓSIA

**ST50/70**

Série: **Multicolor**

Ref.: RM408



PEDRA  
NATURAL





Pedra Natural  
Natural Stone / Pierre naturelle  
Naturstein / Piedra natural



Mate  
Matt / Mat / Mattes / Mate



Interiores e Exteriores  
Indoors and outdoors / Intérieurs et extérieurs  
Drinnen und draußen / Interior y exterior



Variação Média V3  
Average tone variation / Variation moyenne  
Durchschnittliche Tonhöhenchwankung  
Variación media de tono



Resistente ao gelo  
Frost resistant / Résistant au gel  
Frostbeständig / Resistente a las heladas



Espessura  
Thickness / Épaisseur / Dicke / Grosor



Recomendamos o uso de impermeabilizantes  
Water repellent recommend / hydrofuge recommandé  
Wasserabweisend empfehlen  
Recomendamos un Repelente de agua



Dupla colagem  
Double glue / Double encollage  
Doppelkleben / Doble encolado



PCS  
5 Pcs  
0,80 m<sup>2</sup>  
36,07 Kg



PAL  
28 Cx  
22,40 m<sup>2</sup>  
1.018 Kg

# Ardósia Paralelos



40x40 - 15/20mm

ST40/56

Série: **Carmona**

Ref.: RJZS0735B



40x40 - 15/20mm

ST40/56

Série: **Palma**

Ref.: RJZS0736C



40x40 - 15/20mm

ST40/56

Série: **Vigo**

Ref.: RJZS0736B



40x40 - 15/20mm

ST40/56

Série: **Valencia**

Ref.: RJZS0731



PEDRA  
NATURAL



# Fina Stone

powered by <sup>®</sup>Rubicer

## A PEDRA NATURAL MAIS LEVE E FLEXÍVEL DO MERCADO.

FinaStone é uma lâmina de ardósia natural com 1 a 2mm de espessura revestida com fibra de vidro e polyester, proporcionando alta resistência e grande estabilidade dimensional.

Os laminados flexíveis de pedra foram criados pela primeira vez em 1995, quando um designer de móveis em pedra alemão descobriu que quando retirava a ardósia das resinas de uma mesa danificada, ficava sempre uma película de pedra natural "agarrada".

Depois de muitos anos de pesquisa e desenvolvimento, o processo foi aperfeiçoado para uma nova série de produtos naturais laminados flexíveis de pedra natural.

The lightest and most flexible natural stone on the market.

FINASTONE is a laminate of natural slate, 1 to 2 mm thick and coated with fiberglass and polyester, providing high strength and great dimensional stability.

The flexible stone laminates were first created in 1995 when a German slate furniture designer found that when the resins used for slate laminates were removed from a broken table, there remained a stone skin.

After many years of research and development the process has been perfected for a new complete series of natural flexible stone laminate products.

Der leichteste und flexibelste Naturstein auf dem Markt.

FINASTONE ist nur 1 bis 2 mm dick, mit Glasfaser und Polyester beschichtet mit hoher Festigkeit und ausgezeichnete Dimensionsstabilität.

Die flexiblen Stein Laminate wurden erstmals in 1995 erstellt, als ein deutscher Schiefer Möbeldesigner festgestellt hat, dass, wenn die Schiefer vom Harz von einem gebrochenen Tisch entfernt wird, ein Stein Haut bleibt.

Nach vielen Jahren der Forschung und Entwicklung der Prozess, wird sich es verbessert über eine neue komplette flexible Serie von Naturstein Laminate.

La pierre naturelle la plus souple et légère du marché.

FINASTONE est une lame d'ardoise naturelle environ 1 à 2 mm d'épaisseur, renforcée au dos avec une fibre de verre et de polyester, qui lui confèrent une forte résistance et une grande stabilité dimensionnelle.

Les lames en pierre souples ont été créé pour la première fois en 1995, lorsqu'un designer allemand de meubles en ardoise s'est aperçu qu'en retirant d'une table les résines utilisées pour des lames d'ardoise, il restait une peau de pierre.

Après de nombreuses années de recherche et de développement, le processus fut perfectionné afin d'obtenir une nouvelle série complète de produits de lames de pierre souple et naturelle.

La piedra natural más flexible y ligera del mercado

FINASTONE es una lámina de pizarra natural de entre 1 a 2 mm de espesor, recubierta por detrás de fibra de vidrio y polyester, que le proporciona una alta resistencia y gran estabilidad dimensional.

Las láminas flexibles de piedra fueron creadas por primera vez en 1995, cuando un diseñador de muebles de pizarra alemán encontró que cuando las resinas utilizadas para lamas de pizarra fueron retiradas de una mesa rota, quedo una piel de piedra restante.

Después de muchos años de investigación y desarrollo el proceso ha sido perfeccionado para una nueva serie completa de productos de las láminas de piedra flexible y natural.

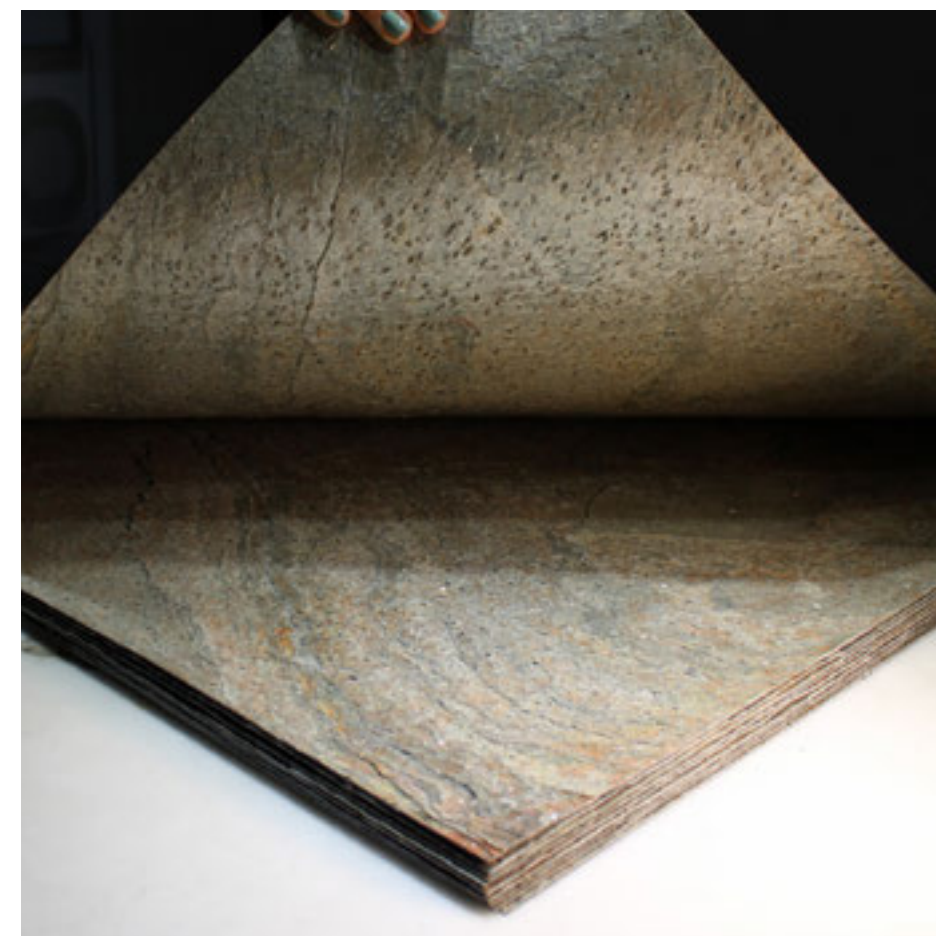

**PEDRAS NATURAIS**  
Natural Stones / Pierres Naturelles  
Natursteine / Piedras Naturales





Pedra Natural Flexível  
Flexible Natural Stone / Pierre naturelle flexible  
Flexibler Naturstein / Piedra natural flexible



Mate  
Matte / Mate / Mattes / Mate



Interiores  
Indoors only / Intérieurs  
Nur drinnen / Solo en interiores



Variação Média V4  
Average tone variation / Variation moyenne  
Durchschnittliche Tonhöfenschwankung  
Variación media de tono



Resistente ao gelo  
Frost resistant / Résistant au gel  
Frostbeständig / Resistente a las heladas



1-2 mm  
Espessura  
Thickness / Épaisseur / Dicke / Grosor



Recomendamos o uso de um hidrofugante  
Water repellent recommend / hydrofuge recommandé  
Wasserabweisend empfehlen  
Recomendamos un Repelente de agua



Requer colagem com  
Recommended glue / Colle préconisée  
Empfohlener Kleber / Pegamento recomendado  
**Kerakoll SLC Eco Grinkol**

62X122  
CX

10 Pcs  
7,442 m<sup>2</sup>  
12 Kg

PAL  
MADEIRA

100 Pcs  
74,42 m<sup>2</sup>  
125 Kg

244X122  
ROLO

5 Pcs  
14,40 m<sup>2</sup>  
25 Kg

PAL  
CAIXOTE

50 Pcs  
144 m<sup>2</sup>  
250 Kg

# Blackish

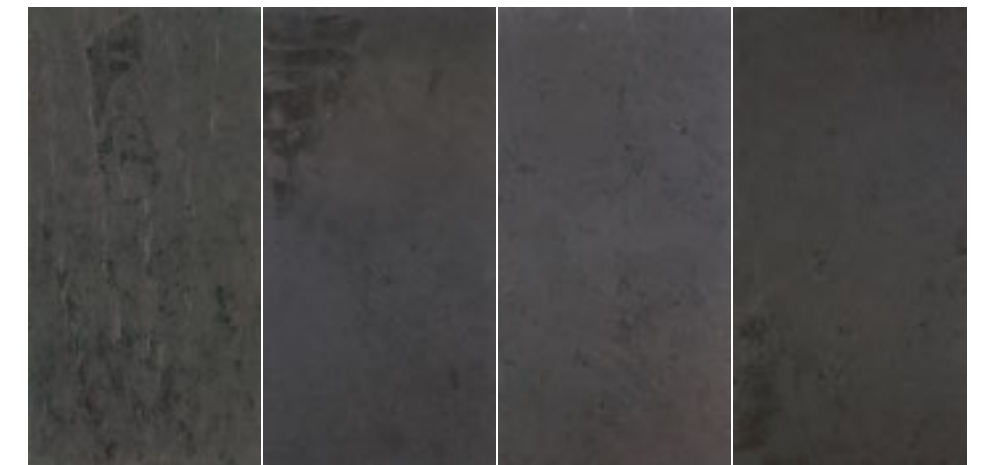

122x61

ST80/112

244x122

ST90/126

Série: **Finastone**



Ref.: RST6001

Série: **Finastone**



Ref.: RST6001244122

# Copper Mix



122x61

ST80/112

244x122

ST90/126

Série: **Finastone**



Ref.: RST6003

Série: **Finastone**



Ref.: RST6003XL





Pedra Natural Flexível  
Flexible Natural Stone / Pierre naturelle flexible  
Flexibler Naturstein / Piedra natural flexible



Mate  
Matte / Mate / Mattes / Mate



Interiores  
Indoors only / Intérieurs  
Nur drinnen / Solo en interiores



Variação Média V4  
Average tone variation / Variation moyenne  
Durchschnittliche Tonhöhenchwankung  
Variación media de tono



Resistente ao gelo  
Frost resistant / Résistant au gel  
Frostbeständig / Resistente a las heladas



1-2 mm  
Espessura  
Thickness / Épaisseur / Dicke / Grosor



Recomendamos o uso de um hidrofugante  
Water repellent recommend / hydrofuge recommandé  
Wasserabweisend empfehlen  
Recomendamos un Repelente de agua



Requer colagem com  
Recommended glue / Colle préconisée  
Empfohlener Kleber / Pegamento recomendado  
**Kerakoll SLc Eco Grinkol**

62X122  
CX

10 Pcs  
7,442 m<sup>2</sup>  
12 Kg

PAL  
MADEIRA

100 Pcs  
74,42 m<sup>2</sup>  
125 Kg

244X122  
ROLO

5 Pcs  
14,40 m<sup>2</sup>  
25 Kg

PAL  
CAIXOTE

50 Pcs  
144 m<sup>2</sup>  
250 Kg

# Acobreado



122x61

ST80/112

244x122

ST90/126

Série: **Finastone**

Ref.: RST6008



5 606779 172358

Série: **Finastone**

Ref.: RST6008244122



5 606779 172365

# Green Waves



122x61

ST80/112

244x122

ST90/126

Série: **Finastone**

Ref.: RST6006



5 606779 191816

Série: **Finastone**

Ref.: RST6006XL



5 606779 183613





Pedra Natural Flexível  
Flexible Natural Stone / Pierre naturelle flexible  
Flexibler Naturstein / Piedra natural flexible



Mate  
Matte / Mate / Mattes / Mate



Interiores  
Indoors only / Intérieurs  
Nur drinnen / Solo en interiores



Variação Média V4  
Average tone variation / Variation moyenne  
Durchschnittliche Tonhöfenschwankung  
Variación media de tono



Resistente ao gelo  
Frost resistant / Résistant au gel  
Frostbeständig / Resistente a las heladas



Espessura  
Thickness / Epaisseur / Dicke / Grosor



Recomendamos o uso de um hidrofugante  
Water repellent recommend / hydrofuge recommandé  
Wasserabweisend empfehlen  
Recomendamos un Repelente de agua



Requer colagem com  
Recommended glue / Colle préconisée  
Empfohlener Kleber / Pegamento recomendado  
**Kerakoll SLc Eco Grinkol**

62X122  
CX

10 Pcs  
7,442 m<sup>2</sup>  
12 Kg

PAL  
MADEIRA

100 Pcs  
74,42 m<sup>2</sup>  
125 Kg

244X122  
ROLO

5 Pcs  
14,40 m<sup>2</sup>  
25 Kg

PAL  
CAIXOTE

50 Pcs  
144 m<sup>2</sup>  
250 Kg

# Oxide

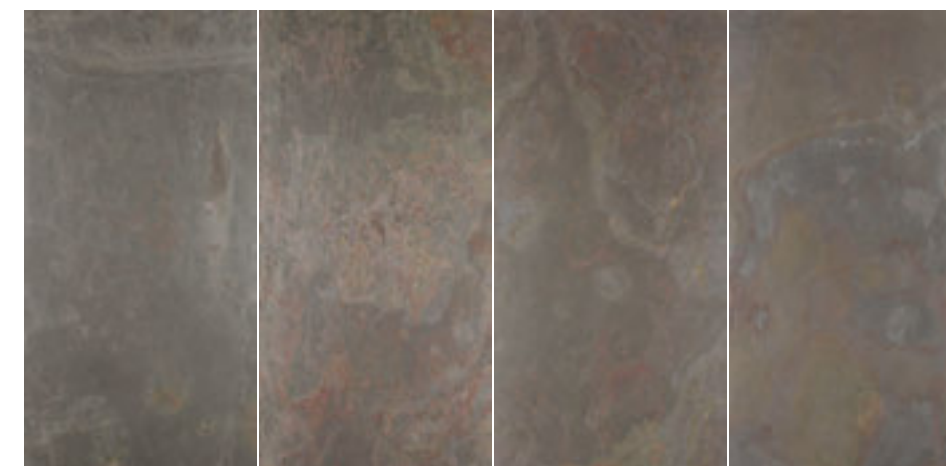

122x61

ST80/112

244x122

ST90/126

Série: **Finastone**



Ref.: RST6011

Série: **Finastone**



Ref.: RST6011XL

# Slate

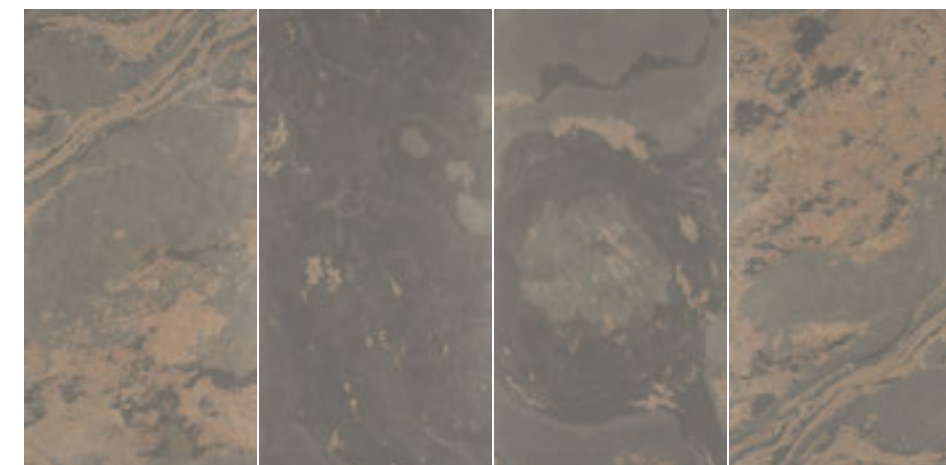

122x61

ST80/112

244x122

ST90/126

Série: **Finastone**



Ref.: RST6010

Série: **Finastone**



Ref.: RST6010XL





Pedra Natural Flexível  
Flexible Natural Stone / Pierre naturelle flexible  
Flexibler Naturstein / Piedra natural flexible



Mate  
Matte / Mate / Mattes / Mate



Interiores  
Indoors only / Intérieurs  
Nur drinnen / Solo en interiores



Variação Média V4  
Average tone variation / Variation moyenne  
Durchschnittliche Tonhöhen schwankung  
Variación media de tono



Resistente ao gelo  
Frost resistant / Résistant au gel  
Frostbeständig / Resistente a las heladas



Espessura  
Thickness / Épaisseur / Dicke / Grosor



Recomendamos o uso de um hidrofugante  
Water repellent recommend / hydrofuge recommandé  
Wasserabweisend empfehlen  
Recomendamos un Repelente de agua



Requer colagem com  
Recommended glue / Colle préconisée  
Empfohlener Kleber / Pegamento recomendado  
**Kerakoll SLc Eco Grinkol**

62X122 CX	244X122 ROLO
10 Pcs 7,442 m <sup>2</sup> 12 Kg	5 Pcs 14,40 m <sup>2</sup> 25 Kg
PAL MADEIRA	PAL CAIXOTE
100 Pcs 74,42 m <sup>2</sup> 125 Kg	50 Pcs 144 m <sup>2</sup> 250 Kg

# TRANSLÚCIDA & OPACA Sand



122x61 Translúcida **ST90/126** 244x122 Translúcida **ST100/140**

Série: **Finastone** Ref.: RST6007TRANS 5 606779 253125 Série: **Finastone** Ref.: RST6007XLTRANS 5 606779 253132

122x61 Opaca **ST80/112** 244x122 Opaca **ST90/126**

Série: **Finastone** Ref.: RST6007 5 606779 182708 Série: **Finastone** Ref.: RST6007XL 5 606779 216199

# Smoky

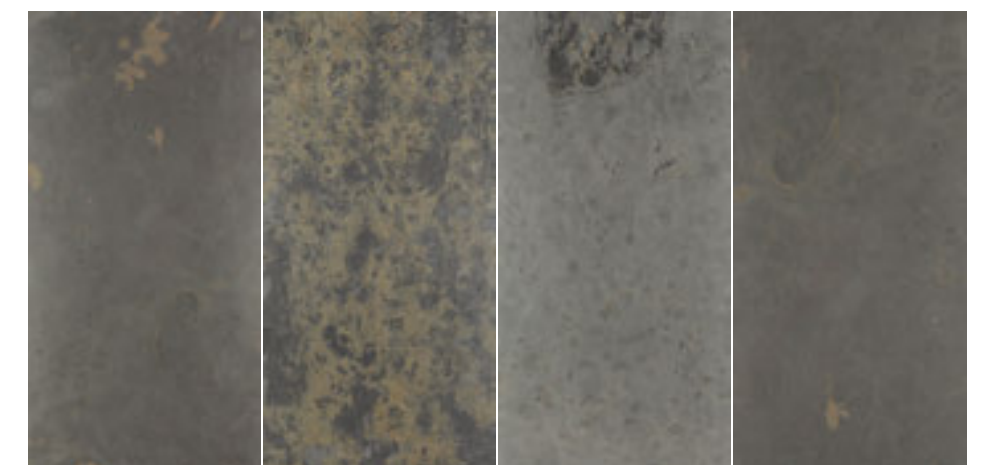

122x61 **ST80/112** 244x122 **ST90/126**

Série: **Finastone** Ref.: RST6012 5 606779 216175 Série: **Finastone** Ref.: RST6012XL 5 606779 216182





Pedra Natural Flexível  
Flexible Natural Stone / Pierre naturelle flexible  
Flexibler Naturstein / Piedra natural flexible



Mate  
Matte / Mate / Mattes / Mate



Interiores  
Indoors only / Intérieurs  
Nur drinnen / Solo en interiores



Variação Média V4  
Average tone variation / Variation moyenne  
Durchschnittliche Tonhöhenchwankung  
Variación media de tono



Resistente ao gelo  
Frost resistant / Résistant au gel  
Frostbeständig / Resistente a las heladas



1-2 mm  
Espessura  
Thickness / Épaisseur / Dicke / Grosor



Recomendamos o uso de um hidrofugante  
Water repellent recommend / hydrofuge recommandé  
Wasserabweisend empfehlen  
Recomendamos un Repelente de agua



Requer colagem com  
Recommended glue / Colle préconisée  
Empfohlener Kleber / Pegamento recomendado  
**Kerakoll SLc Eco Grinkol**

62X122  
CX

10 Pcs  
7,442 m<sup>2</sup>  
12 Kg

PAL  
MADEIRA

100 Pcs  
74,42 m<sup>2</sup>  
125 Kg

244X122  
ROLO

5 Pcs  
14,40 m<sup>2</sup>  
25 Kg

PAL  
CAIXOTE

50 Pcs  
144 m<sup>2</sup>  
250 Kg

# Ocre



122x61

ST80/112

244x122

ST90/126

Série: **Finastone**



Ref.: RST6005

Série: **Finastone**



Ref.: RST6005XL

# Curly

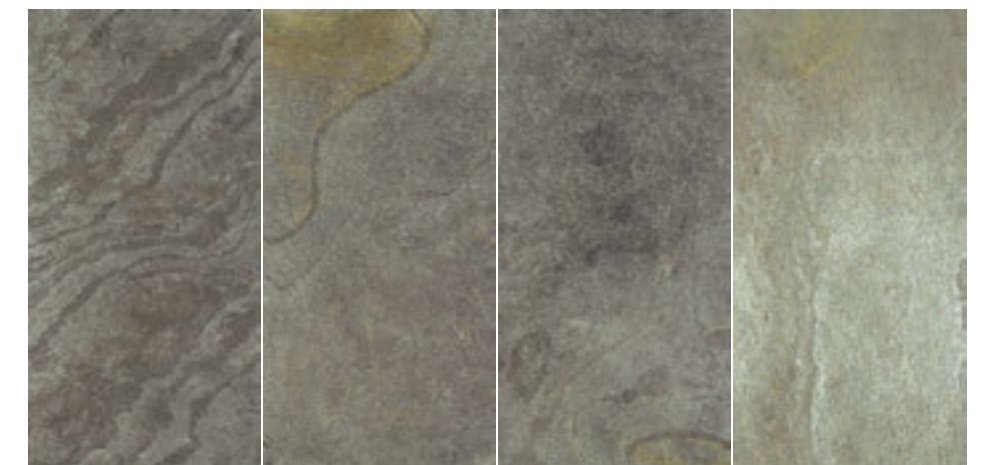

122x61

ST80/112

244x122

ST90/126

Série: **Finastone**



Ref.: RST6009

Série: **Finastone**



Ref.: RST6009244122





## PASTILHAS E MOSAICOS

Mosaics / Mosaiques

Mosaik / Mosaicos





Porcelânico Esmaltado  
Glazed tiles, Grès cérame émaillé,  
Feinsteinzeug Glasiert, Porcelánico esmaltado



Mate  
Matt / Mat / Matt / Mate



Interiores e Exteriores  
Indoors and outdoors / Intérieurs et extérieurs  
Drinnen und draußen / Interior y exterior



Variação Média V4  
Average tone variation / Variation moyenne  
Durchschnittliche Tonhöhenchwankung  
Variación media de tono



Resistente ao gelo  
Frost resistant / Résistant au gel  
Frostbeständig / Resistente a las heladas



Espessura  
Thickness / Épaisseur / Dicke / Grosor



Requer cola para piscinas  
Pool cement / Ciment pour piscine  
Poolkleber / Cemento para piscinas



Adequado a piscinas  
Suitable for pools / Adapté aux piscines  
Geignet für Pools / Apto para piscinas



50 Pcs  
1,04 m<sup>2</sup>  
15,15 Kg



72 Cx  
74,88 m<sup>2</sup>  
1.075 Kg

## Verano Fresco

Porcelânico para Interiores, Exteriores e Piscinas



14,5x14,5cm

M40/56

Cor: **Fresco**

Ref: RVE1515FREEXT



5 606779 242525

## Verano Brisa



14,5x14,5cm

M40/56

Cor: **Brisa**

Ref: RVE1515BRIEXT



5 606779 242532



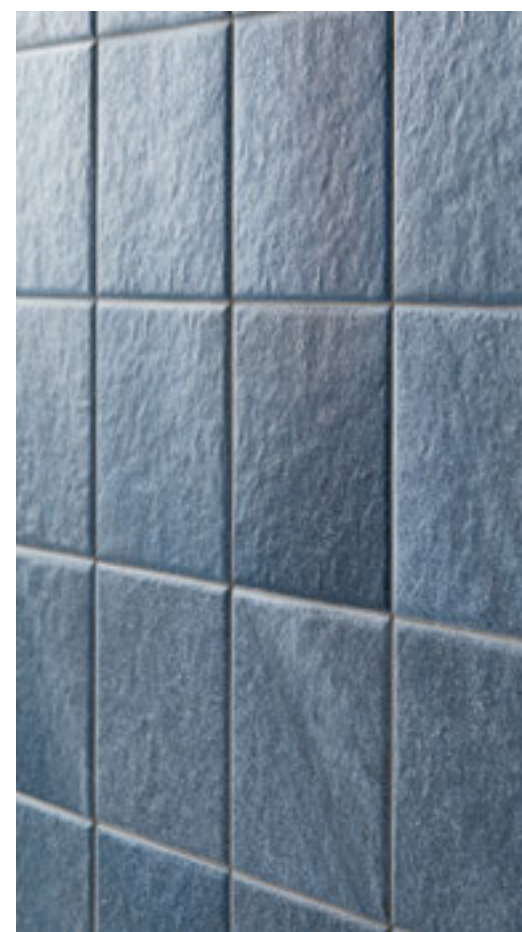
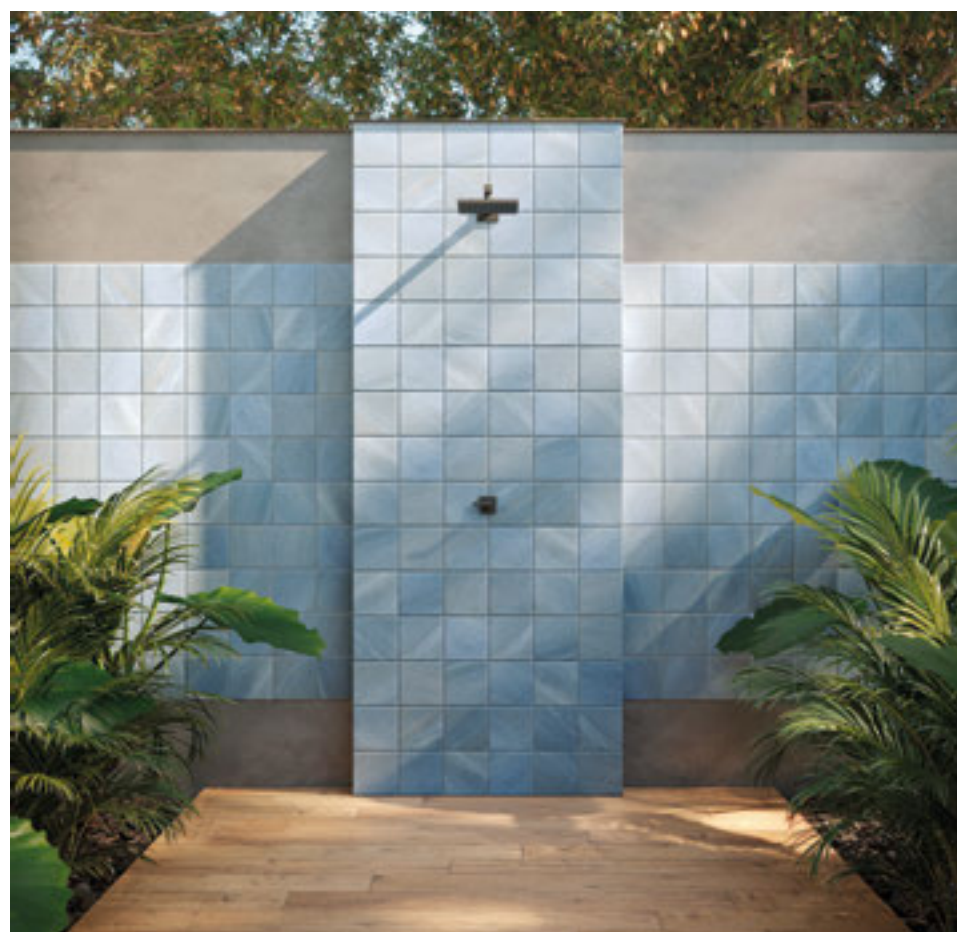

PE

Porcelânico Esmaltado  
Glazed tiles / Grès cérame émaillé,  
Feinsteinzeug Glasiert, Porcelánico esmaltado



Mate  
Matt / Mat / Matt / Mate



Interiores e Exteriores  
Indoors and outdoors / Intérieurs et extérieurs  
Dinnen und draußen / Interior y exterior



Variação Média V4  
Average tone variation / Variation moyenne  
Durchschnittliche Tonhöhen schwankung  
Variación media de tono



Resistente ao gelo  
Frost resistant / Résistant au gel  
Frostbeständig / Resistente a las heladas



Espessura  
Thickness / Épaisseur / Dicke / Grosor



Requer cola para piscinas  
Pool cement / Ciment pour piscine  
Poolkleber / Cemento para piscinas



Adequado a piscinas  
Suitable for pools / Adapté aux piscines  
Geignet für Pools / Apto para piscinas



PCS  
50 Pcs  
1,04 m<sup>2</sup>  
15,15 Kg



PAL  
72 Cx  
74,88 m<sup>2</sup>  
1.075 Kg

## Verano Esmeralda

Porcelânico para Interiores, Exteriores e Piscinas



14,5x14,5cm

M40/56

Cor: **Esmeralda**

Ref.: RVEI515ESMEXT



5 606779 242556

## Verano Cielo



14,5x14,5cm

M40/56

Cor: **Cielo**

Ref.: RVEI515CIEEXT



5 606779 242549





Vidro  
Glass / Verre / Vidrio / Glas

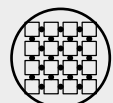

Pontos de PVC  
PVC dots support / Support avec PVC  
Unterstützung für PVC-Punkte / Puntos de PVC



Mate  
Matt / Matte / Mate



Interiores e Exteriores  
Indoors and outdoors / Intérieurs et Extérieurs  
Dinnen und draußen / Interior y exterior



Variação Média V2



Resistente ao gelo  
Frost resistant / Résistant au gel  
Frostbeständig / Resistente a las heladas

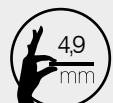

Espessura  
Thickness / Épaisseur / Dicke / Grosor



Requer cola para piscinas  
Pool cement / Ciment pour piscine  
Poolkleber / Cemento para piscinas



Adequado a piscinas  
Suitable for pools / Adapté aux piscines  
Geeignet für Pools / Apto para piscinas



PCS  
1 Pc  
0,107m<sup>2</sup>  
1,32 Kg



CX  
14 Pcs  
2,03 m<sup>2</sup>  
18,48 Kg

# Swim Bali



Tela: 31x46,7cm  
Pixel: 25x25mm

M50/70

M8/11.2

Cor: **Bali**

Ref.: RM2004319BALI



5 606779 208910

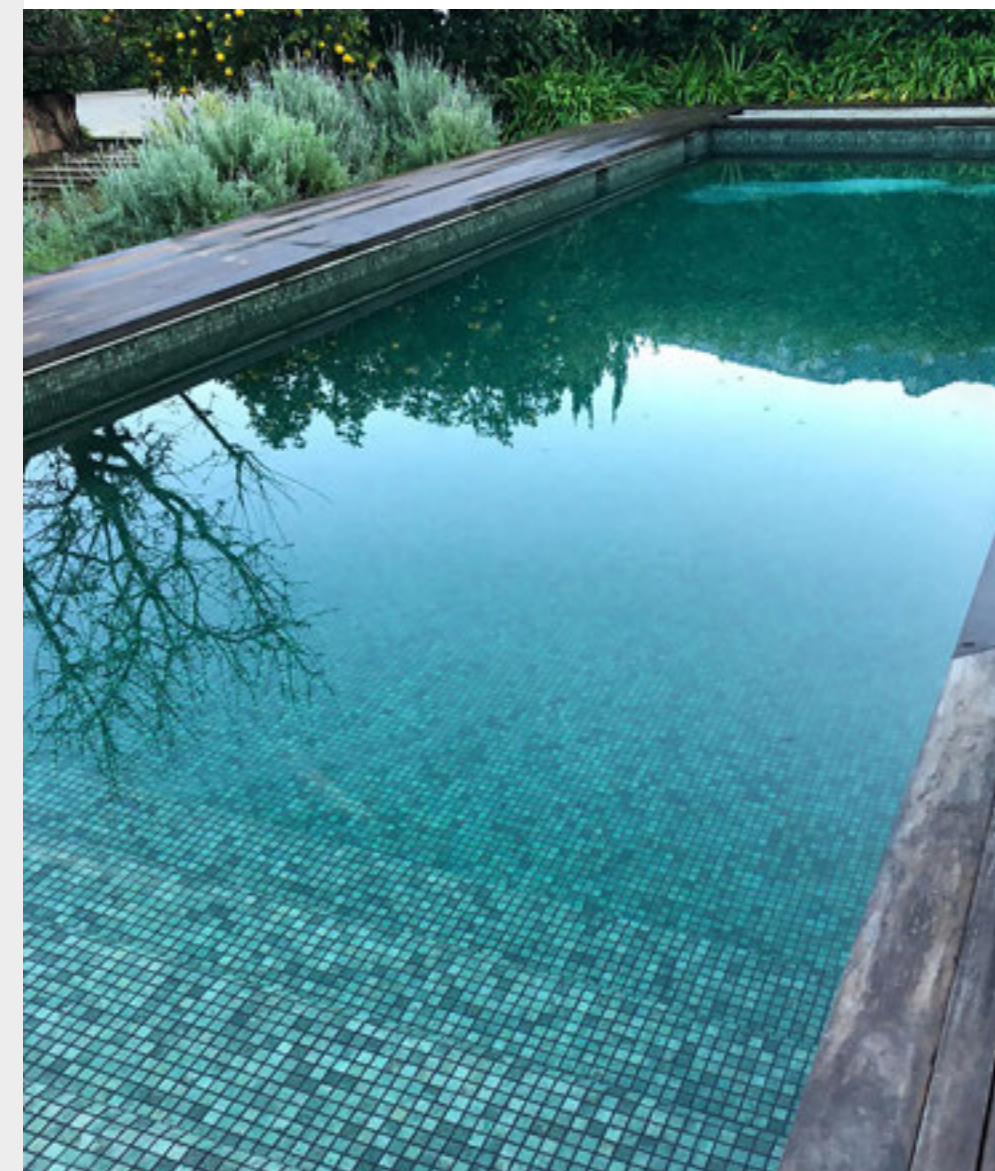





Vidro  
Glass / Verre / Vidrio / Glas



Colado em rede  
Mesh mosaic / Mosaïque collés sur trame  
Mosaik auf netz geklebt / Mosaico en malla



Mate  
Matt / Mat / Mattes / Mate



Interiores e Exteriores  
Indoors and outdoors / Intérieurs et extérieurs  
Dinnen und draußen / Interior y exterior



Variação Média V1  
Average tone variation / Variation moyenne  
Durchschnittliche Tonhöhenchwankung  
Variación media de tono



Resistente ao gelo  
Frost resistant / Résistant au gel  
Frostbeständig / Resistente a las heladas



Espessura  
Thickness / Epaisseur / Dicke / Grosor



Requer cola para piscinas  
Pool cement / Ciment pour piscine  
Poolkleber / Cemento para piscinas



Adequado a piscinas  
Suitable for pools / Adapté aux piscines  
Geeignet für Pools / Apto para piscinas



1 Pc  
0,107m<sup>2</sup>  
0,70 Kg



20 Pcs  
2,14 m<sup>2</sup>  
14 Kg

# Pool

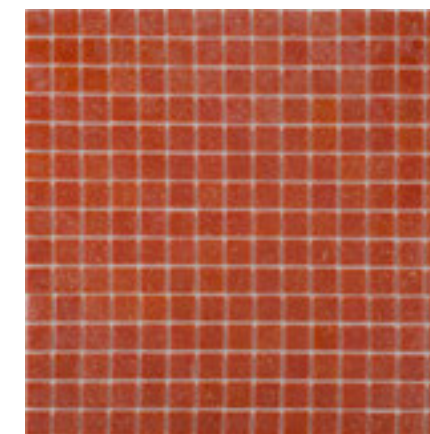

**M60/84**  
32,7x32,7cm **M7/10**

Cor: **Paixão**

Ref.: 2525PAIXAO1

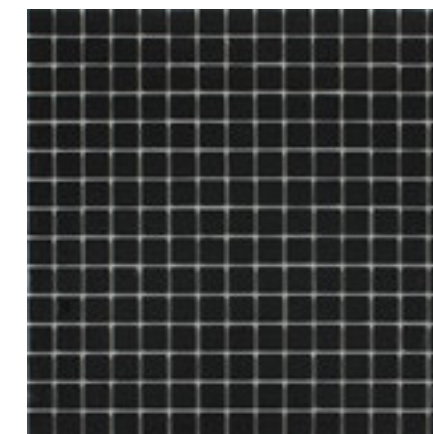

**M30/42**  
32,7x32,7cm **M4/5.6**

Cor: **Terra**

Ref.: 2525TERRA1

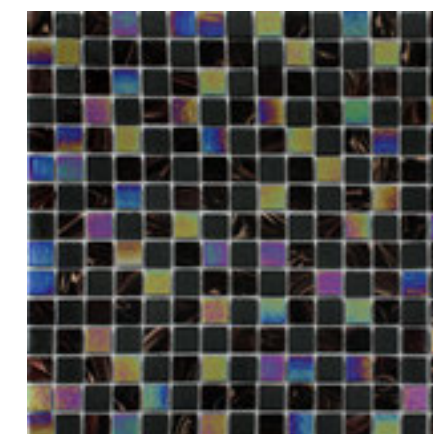

**M40/56**  
32,7x32,7cm **M5/7**

Cor: **Indiana**

Ref.: RM01







Vidro  
Glass / Verre / Vidrio / Glas



Colado em rede  
Mesh mosaic / Mosaïque collés sur trame  
Mosaik auf netz geklebt / Mosaico en malla



Mate  
Matt / Mat / Mattes / Mate



Interiores e Exteriores  
Indoors and outdoors / Intérieurs et extérieurs  
Drinnen und draußen / Interior y exterior



Variação Média V1  
Average tone variation / Variation moyenne  
Durchschnittliche Tonhöhenchwankung  
Variación media de tono



Resistente ao gelo  
Frost resistant / Résistant au gel  
Frostbeständig / Resistente a las heladas

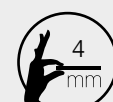

Espessura  
Thickness / Épaisseur / Dicke / Grosor



Requer cola para piscinas  
Pool cement / Ciment pour piscine  
Poolkleber / Cemento para piscinas



Adequado a piscinas  
Suitable for pools / Adapté aux piscines  
Geeignet für Pools / Apto para piscinas



1 Pc  
0,107m<sup>2</sup>  
0,77 Kg



20 Pcs  
2,14 m<sup>2</sup>  
15,30 Kg

# Pool

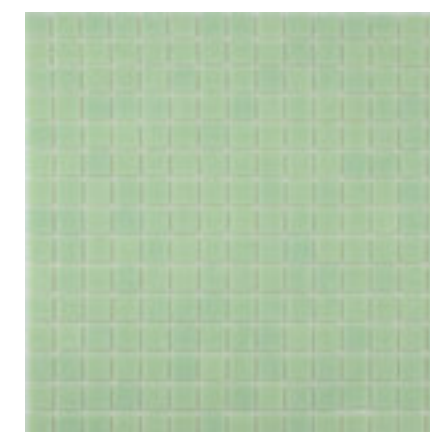

**M24/34**

32,7x32,7cm **M3/4.2**

Cor: **Caribe**

Ref.: 22A42



**M24/34**

32,7x32,7cm **M3/4.2**

Cor: **Neve**

Ref.: 2525FIR1

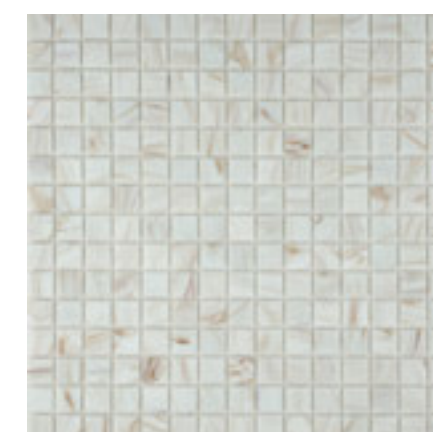

**M40/56**

32,7x32,7cm **M5/7**

Cor: **London**

Ref.: 2020G12



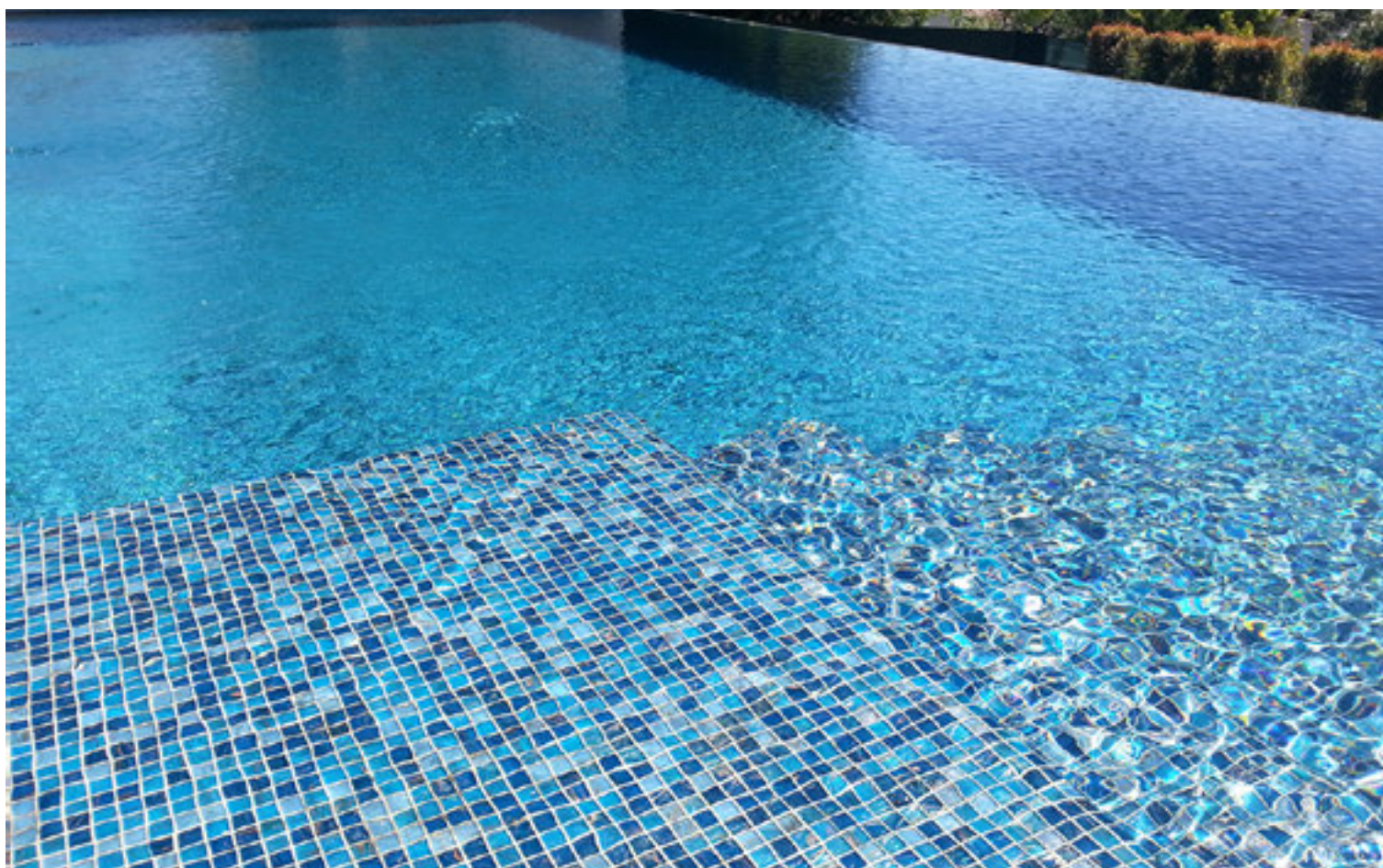

Vidro  
Glass / Verre / Vidrio / Glas



Colado em rede  
Mesh mosaic / Mosaïque collés sur trame  
Mosaik auf netz geklebt / Mosaico en malla



Mate e Brilho  
Matt and Gloss / Mat et brillant  
Matt und glänzend / Mate y Brillo



Interiores e Exteriores  
Indoors and outdoors / Intérieurs et extérieurs  
Dinnen und draußen / Interior y exterior



Variação Média V3  
Average tone variation / Variation moyenne  
Durchschnittliche Tonhöhenchwankung  
Variación media de tono



Resistente ao gelo  
Frost resistant / Résistant au gel  
Frostbeständig / Resistente a las heladas

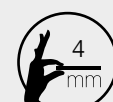

Espessura  
Thickness / Epaisseur / Dicke / Grosor



Requer cola para piscinas  
Pool cement / Ciment pour piscine  
Poolkleber / Cemento para piscinas



Adequado a piscinas  
Suitable for pools / Adapté aux piscines  
Geeignet für Pools / Apto para piscinas



POOL

1 Pc  
0,107m<sup>2</sup>  
0,77 Kg



OCEAN

1 Pc  
0,09 m<sup>2</sup>  
0,815 Kg



CX

20 Pcs  
2,14 m<sup>2</sup>  
15,30 Kg



CX

20 Pcs  
1,74 m<sup>2</sup>  
15,20 Kg

# Pool

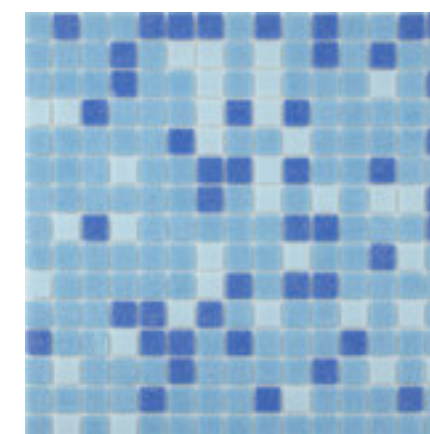

M24/34

32,7x32,7cm

Cor: **Combi Mix**

Ref.: 2525MIXR1



s 606779 108678

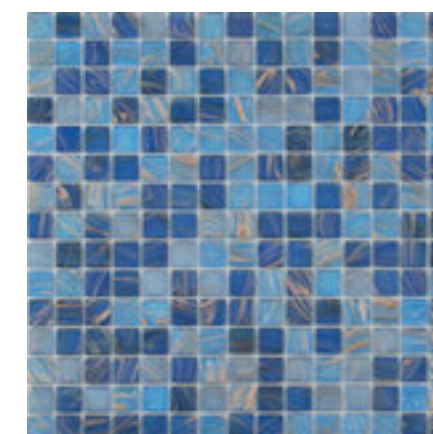

M40/56

32,7x32,7cm

Cor: **Giverny**

Ref.: 2020GIVERNY1



s 606779 106391



M85/119

30x30cm

Cor: **Ocean**

Ref.: RMGR25B01



s 606779 192479





Vidro  
Glass / Verre / Vidrio / Glas



Colado em rede  
Mesh mosaic / Mosaïque collés sur trame  
Mosaik auf netz geklebt / Mosaico en malla



Mate  
Matt / Mat / Mattes / Mate



Interiores e Exteriores  
Indoors and outdoors / Intérieurs et extérieurs  
Drinnen und draußen / Interior y exterior



Variação Média V1  
Average tone variation / Variation moyenne  
Durchschnittliche Tonhöhenchwankung  
Variación media de tono



Resistente ao gelo  
Frost resistant / Résistant au gel  
Frostbeständig / Resistente a las heladas

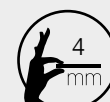

Espessura  
Thickness / Epaisseur / Dicke / Grosor



Requer cola para piscinas  
Pool cement / Ciment pour piscine  
Poolkleber / Cemento para piscinas



Adequado a piscinas  
Suitable for pools / Adapté aux piscines  
Geeignet für Pools / Apto para piscinas



1 Pc  
0,107m<sup>2</sup>  
0,77 Kg



20 Pcs  
2,14 m<sup>2</sup>  
15,30 Kg

# Pool

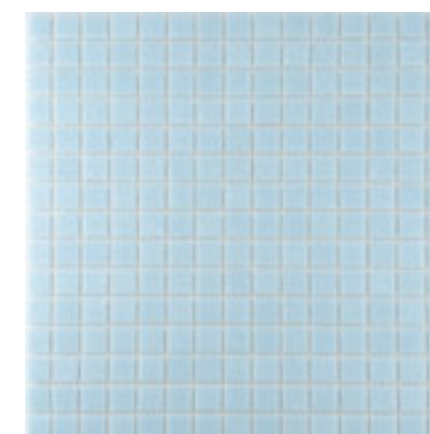

32,7x32,7cm

Cor: **Bebé**

Ref.: 22A51R

M24/34

M3/4.2

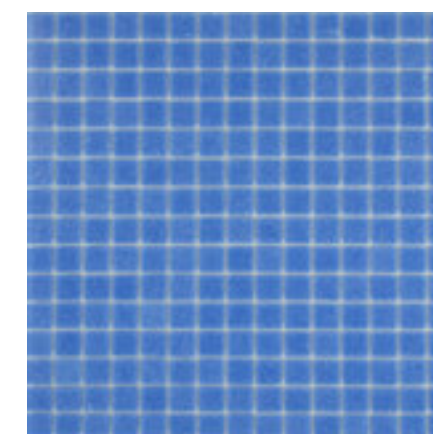

32,7x32,7cm

Cor: **Céu**

Ref.: 2525F63R1

M24/34

M3/4.2

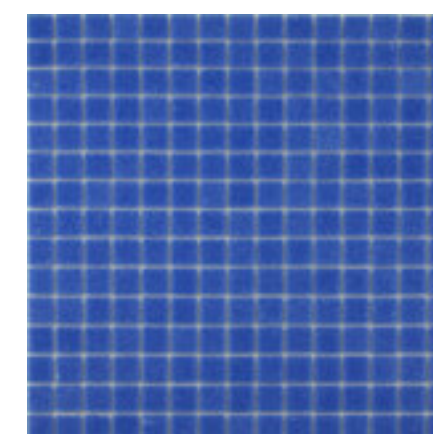

32,7x32,7cm

Cor: **Água**

Ref.: 2525F55R1

M24/34

M3/4.2







Vidro  
Glass / Verre / Vidrio / Glas



Colado em rede  
Mesh mosaic / Mosaïque collés sur trame  
Mosaik auf netz geklebt / Mosaico en malla



Mate e Brilho  
Matt and Gloss / Mat et brillant  
Matt und glänzend / Mate y Brillo



Interiores e Exteriores  
Indoors and outdoors / Intérieurs et extérieurs  
Dinnen und draußen / Interior y exterior



Varição Média V1  
Average tone variation / Variation moyenne  
Durchschnittliche Tonhöhenchwankung  
Variación media de tono



Resistente ao gelo  
Frost resistant / Résistant au gel  
Frostbeständig / Resistente a las heladas



Espessura  
Thickness / Epaisseur / Dicke / Grosor



Requer cola para piscinas  
Pool cement / Ciment pour piscine  
Poolkleber / Cemento para piscinas



Adequado a piscinas  
Suitable for pools / Adapté aux piscines  
Geeignet für Pools / Apto para piscinas

# Pool Decor



Pixel  
20x20mm  
colado em rede

3x3m

M1450/2030

Série: Pool Decor

Ref.: GOLFINHOS



5 606779 141637

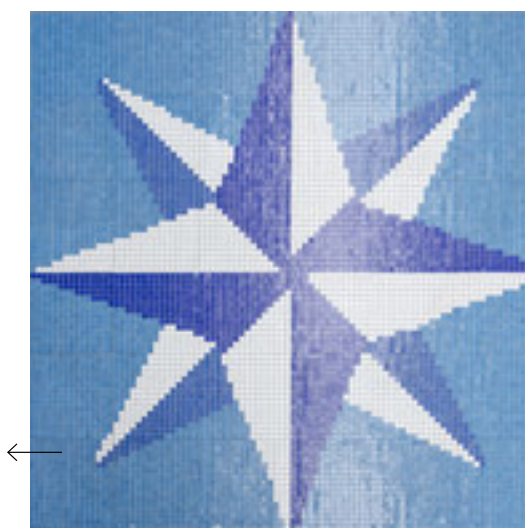

Pixel  
20x20mm  
colado em rede

2x2m

M650/910

Série: Pool Decor

Ref.: ESTRELA



5 606779 140104

310mm

Pixel  
25x25mm  
colado em papel

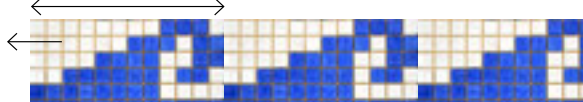

31x15,2cm

M6/8.4

Série: Pool Decor Cenefa

Ref.: CENF202B



5 606779 135964





Marilyn Monroe

M2000/2800

Dim: 1200x2400mm

Pixel: 10x10mm

Ref.: MARLYNMONROE



5 606779 144270



Colado em rede  
mesh mosaic / mosaïque collés sur trame  
mosaik auf netz geklebt / mosaico en malla



Espessura  
Thickness / Épaisseur / Dicke / Grosor

Elvis Presley

M2000/2800

Dim: 1200x2400mm

Pixel: 10x10mm

Ref.: RELVIS120240



5 606779 209252

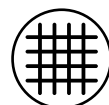

Colado em rede  
mesh mosaic / mosaïque collés sur trame  
mosaik auf netz geklebt / mosaico en malla



Espessura  
Thickness / Épaisseur / Dicke / Grosor



Espessura  
Thickness / Épaisseur / Dicke / Grosor



Colado em rede  
mesh mosaic / mosaïque collés sur trame  
mosaik auf netz geklebt / mosaico en malla

Amália Rodrigues

M2000/2800

Dim: 1200x2400mm

Pixel: 10x10mm

Ref.: RAMALIA120240



5 606779 209245





Eddie Vedder

Dim: **1200x2400mm**  
Pixel: **10x10mm**

Ref.: REDDIEVEDER120240

M2000/2800



5 606779 209283

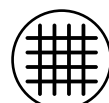

Colado em rede  
mesh mosaic / mosaïque collés sur trame  
mosaik auf netz geklebt / mosaico en malla



Espessura  
Thickness / Épaisseur / Dicke / Grosor



Espessura  
Thickness / Épaisseur / Dicke / Grosor



Colado em rede  
mesh mosaic / mosaïque collés sur trame  
mosaik auf netz geklebt / mosaico en malla

Lana Del Rey

Dim: **1200x2400mm**  
Pixel: **10x10mm**

Ref.: RLANADELREY120240

M2000/2800



5 606779 209276





Vidro e Pedra  
 Glass and stone / Verre et pierre  
 Glas und Stein / Vidrio y Pedra



Colado em rede  
 mesh mosaic / mosaïque collés sur trame  
 mosaik auf netz geklebt / mosaico en malla



Mate  
 Matte / Mate / Mattes / Mate



Interiores e Exteriores  
 Indoors and Outdoors / intérieurs et extérieurs  
 Drinnen und draußen / Interior y exterior



Variação Média V1  
 Average tone variation / Variation moyenne  
 Durchschnittliche Tonhöhenchwankung  
 Variación media de tono



Resistente ao gelo  
 Frost resistant / Résistant au gel  
 Frostbeständig / Resistente a las heladas



Espessura  
 Thickness / Épaisseur / Dicke / Grosor



Requer cola para vidro  
 Glass adhesive / Colle pour verre  
 Kleber für Glas / Pegamento para vidrio



1 Pc  
 0,09 m<sup>2</sup>  
 1 Kg



11 Pcs  
 1 m<sup>2</sup>  
 12 Kg

# Victory

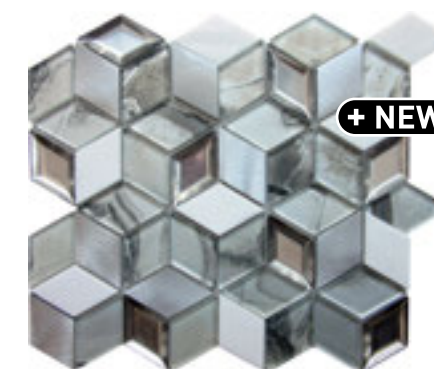

**+ NEW**

30x30cm

M180/252

M18/25.2

Cor: **White - Gloss**

Ref.: RMVICWH



5 606779 253279

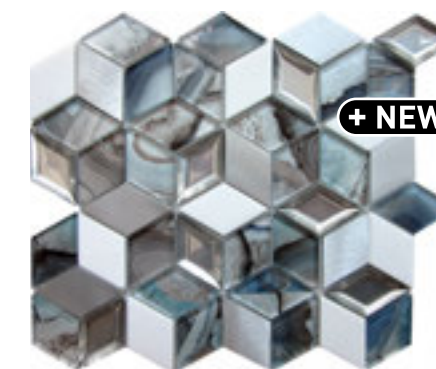

**+ NEW**

30x30cm

M180/252

M18/25.2

Cor: **Blue Grey - Gloss**

Ref.: RMVICBLGR



5 606779 253286

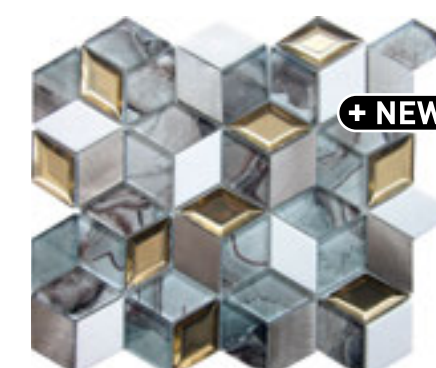

**+ NEW**

30x30cm

M180/252

M18/25.2

Cor: **Gold - Gloss**

Ref.: RMVICGLD



5 606779 253293





Cerâmica  
Ceramics / Céramique  
Keramik / Cerámica



Colado em rede  
mesh mosaic / mosaïque collés sur trame  
mosaik auf netz geklebt / mosaico en malla



Mate  
Matte / Mate / Mattes / Mate



Interiores e Exteriores Cobertos  
Covered Indoor and Outdoor / Intérieur et extérieur couvert  
Innen- und Außenbereich abgedeckt  
Interior y exterior cubierto



Variação Média V1  
Average tone variation / Variation moyenne  
Durchschnittliche Tonhöhenchwankung  
Variación media de tono



Resistente ao gelo  
Frost resistant / Résistant au gel  
Frostbeständig / Resistente a las heladas



Espessura  
Thickness / Epaisseur / Dicke / Grosor



Cola para porcelânicos  
Porcelain Adhesive / Colle pour grès cérame  
Kleber für Porzellanfliesen / Pegamento para porcelánico



PCS  
1 Pc  
0,09 m<sup>2</sup>  
1 Kg



CX  
12 Pcs  
1,08 m<sup>2</sup>  
12 Kg

# Gaudi

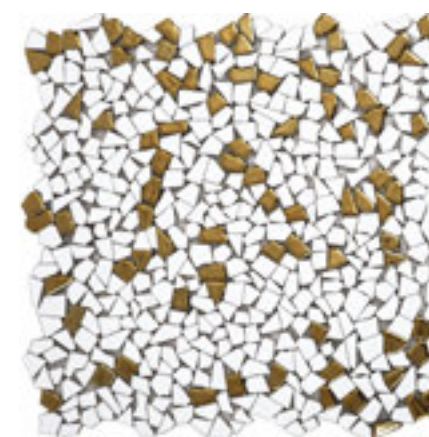

**31x31cm** **M150/210**   
**Cor: White - Gloss** **M15/21**   
Ref.: RMGAUDIWG 5 606779 202253

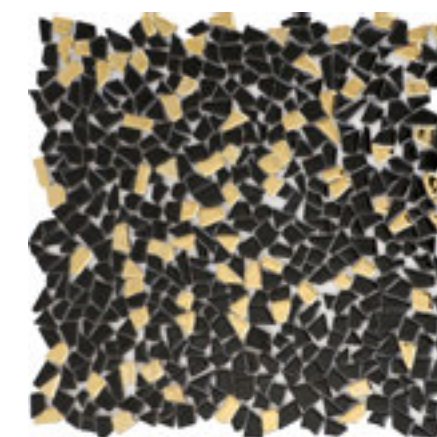

**31x31cm** **M150/210**   
**Cor: Black - Gloss** **M15/21**   
Ref.: RMGAUDIBKG 5 606779 202260





Vidro  
Glass / Verre / Glas / Vidrio



Colado em rede  
mesh mosaic / mosaïque collés sur trame  
mosaik auf netz geklebt / mosaico en malla



Brilho  
Gloss / Brillant / Glanz / Brillo



Interiores  
Indoors only



Variação Média V1  
Average tone variation / Variation moyenne  
Durchschnittliche Tonhöenschwankung  
Variación media de tono



Resistente ao gelo  
Frost resistant / Résistant au gel  
Frostbeständig / Resistente a las heladas



Espessura  
Thickness / Épaisseur / Dicke / Grosor



Requer cola para vidro  
Glass adhesive / Colle pour verre  
Kleber für Glas / Pegamento para vidrio



PCS  
1 Pc  
0,09 m<sup>2</sup>  
1,36 Kg



CX  
11 Pcs  
1 m<sup>2</sup>  
15 Kg

# Magnific



M200/280

30x30cm

M20/28

Cor: **Silver White - Gloss**

Ref.: RMMAG2473A04SW 



M200/280

30x30cm

M20/28

Cor: **Silver Black - Gloss**

Ref.: RMMAG2473A05SBK 



M200/280

30x30cm

M20/28

Cor: **Gold - Gloss**

Ref.: RMMAG4848C09GLD 



M200/280

30x30cm

M20/28

Cor: **Rose Gold - Gloss**

Ref.: RMMAG2473B02RG 





Vidro  
Glass / Verre / Glas / Vidrio



Colado em rede  
mesh mosaic / mosaïque collés sur trame  
mosaik auf netz geklebt / mosaico en malla



Brilho  
Gloss / Brillant / Glanz / Brillo



Interiores  
Indoors only / À l'intérieur seulement  
Nur drinnen / Solo en interiores



Variação Média V1  
Average tone variation / Variation moyenne  
Durchschnittliche Tonhöhenchwankung  
Variación media de tono



Resistente ao gelo  
Frost resistant / Résistant au gel  
Frostbeständig / Resistente a las heladas



Espessura  
Thickness / Epaisseur / Dicke / Grosor



Requer cola para vidro  
Glass adhesive / Colle pour verre  
Kleber für Glas / Pegamento para vidrio

PCS  
1 Pc  
0,09 m<sup>2</sup>  
1,45 Kg

CX  
11 Pcs  
1 m<sup>2</sup>  
16 Kg

PCS  
1 Pc  
0,09 m<sup>2</sup>  
1,14 Kg

CX  
14 Pcs  
1,272 m<sup>2</sup>  
16 Kg



# Diamond

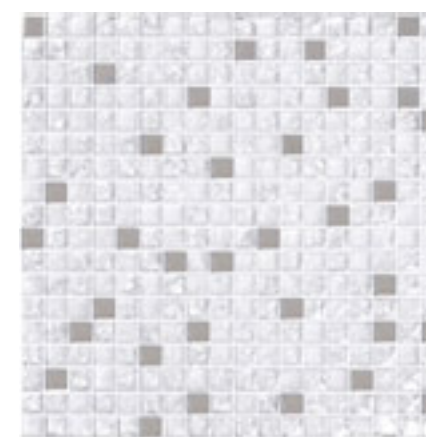

30x30cm  
Cor: **White - Gloss**  
Ref.: RMLRS15A

M140/196  
M14/19.6

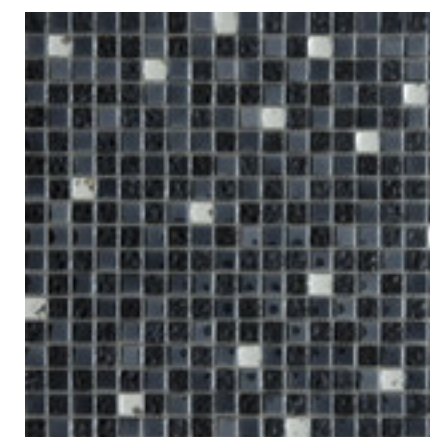

30x30cm  
Cor: **Black - Gloss**  
Ref.: RMLRM15A

M140/196  
M14/19.6



# Brick

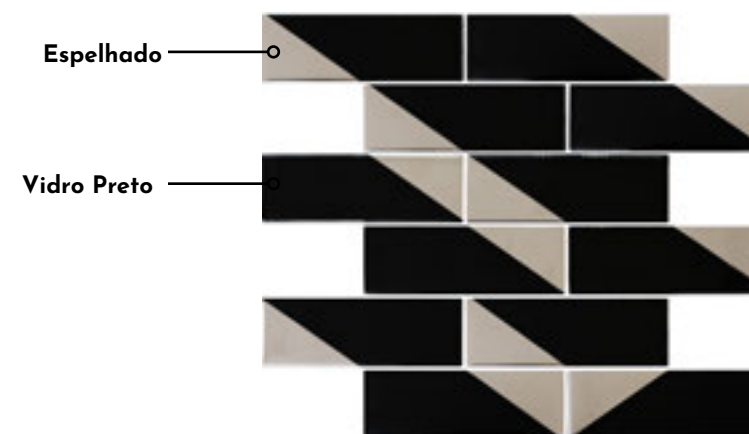

30x30cm  
Cor: **Black & Silver - Gloss**  
Ref.: RM48148BRPR

M185/259  
M18.5/25.9







Vidro e Pedra  
 Glass and stone / Verre et pierre  
 Glas und Stein / Vidrio y Pedra



Colado em rede  
 mesh mosaic / mosaïque collés sur trame  
 mosaik auf netz geklebt / mosaico en malla



Mate e Brilha  
 Matt and Glass / Mat et brillant  
 Matt und glänzend / Mate y Brillo



Interiores  
 Indoors only / Intérieurs  
 Nur drinnen / Solo en interiores



Variação Média V2  
 Average tone variation / Variation moyenne  
 Durchschnittliche Tonhöhenchwankung  
 Variación media de tono



Resistente ao gelo  
 Frost resistant / Résistant au gel  
 Frostbeständig / Resistente a las heladas



Espessura  
 Thickness / Epaisseur / Dicke / Grosor



Requer cola para vidro  
 Glass adhesive / Colle pour verre  
 Kleber für Glas / Pegamento para vidrio



1 Pc  
 0,09 m<sup>2</sup>  
 1,13 Kg



22 Pcs  
 1,98 m<sup>2</sup>  
 24,16 Kg

# Montblanc



30x30cm **M200/280**  
 **M20/28**

Cor: **Basalt**

Ref.: RMMONTB



5 606779 180162

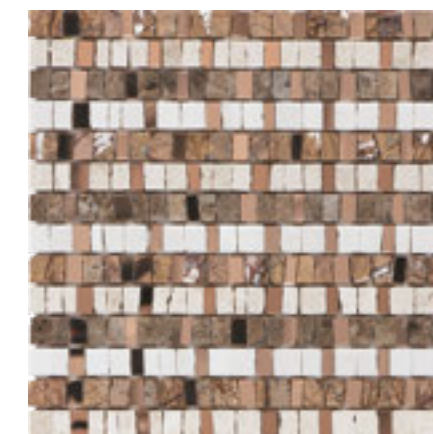

30x30cm **M200/280**  
 **M20/28**

Cor: **Aguilá**

Ref.: RMMONTA



5 606779 180179

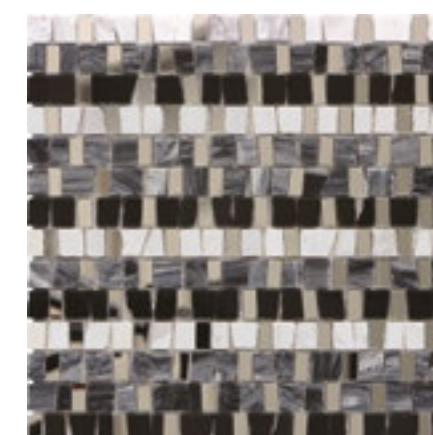

30x30cm **M200/280**  
 **M20/28**

Cor: **Marquina**

Ref.: RMMONTM



5 606779 180186



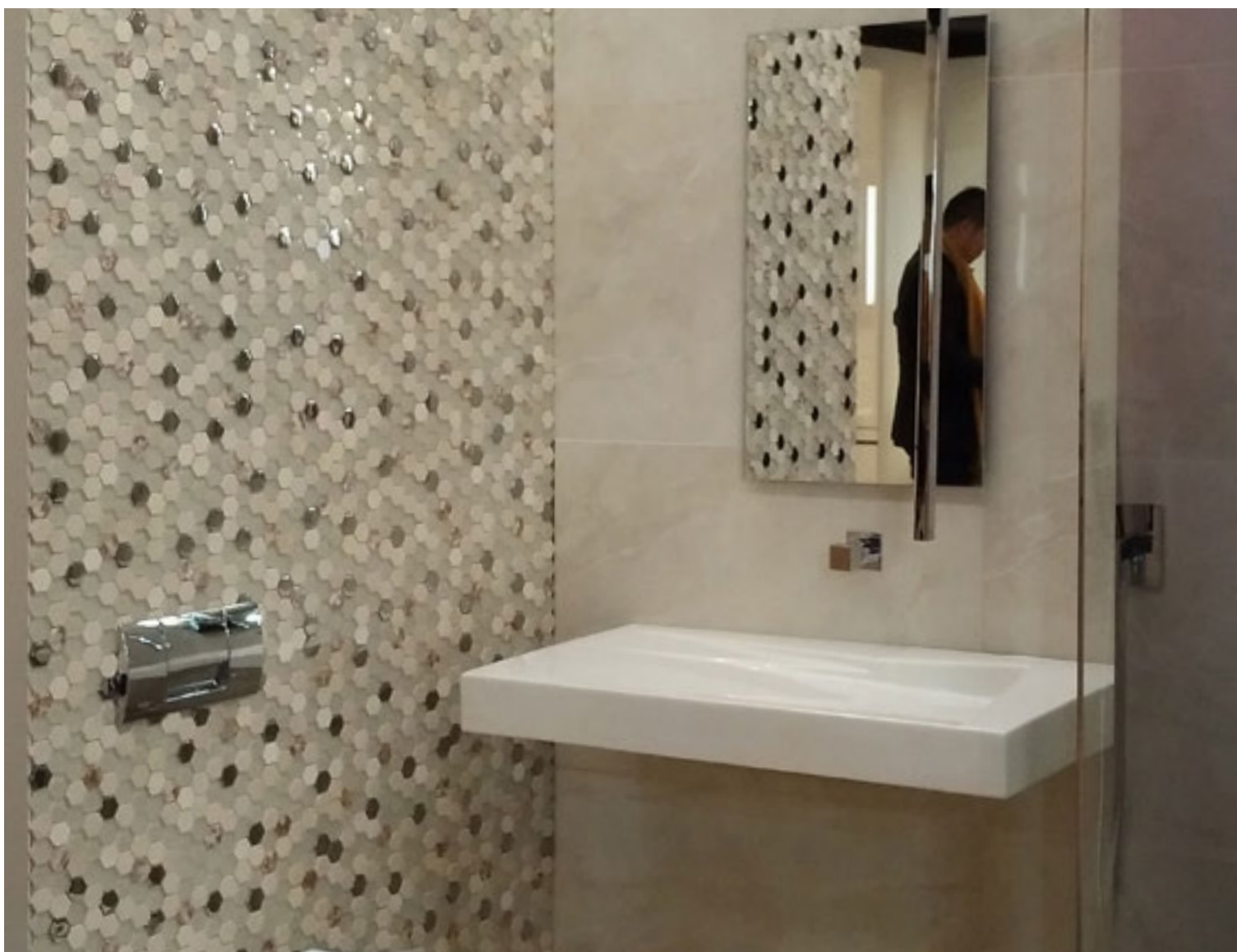

Vidro, Pedra e Madre pérola  
Glass, stone and mother-of-pearl  
Verre, pierre et nacre / Glas, stein und perlmutter  
Vidrio, piedra y madreperla



Colado em rede  
mesh mosaic / mosaïque collés sur trame  
mosaik auf netz geklebt / mosaico en malla



Mate e Brilho  
Matt and Gloss / Mat et brillant  
Matt und glanzend / Mate y Brillo



Interiores  
Indoors only / Intérieurs  
Nur drinnen / Solo en interiores



Variação Média V2  
Average tone variation / Variation moyenne  
Durchschnittliche Tonhöhenchwankung  
Variación media de tono



Resistente ao gelo  
Frost resistant / Résistant au gel  
Frostbeständig / Resistente a las heladas



Espessura  
Thickness / Epaisseur / Dicke / Grosor



Requer cola para vidro  
Glass adhesive / Colle pour verre  
Kleber für Glas / Pegamento para vidrio



1 Pc  
0,09 m<sup>2</sup>  
1 Kg



11 Pcs  
1 m<sup>2</sup>  
18 Kg

# Hexagone



30,5x29,5cm

Cor: **Shell Beige**

Ref.: RMHEXABS

M185/259

M18.5/25.9

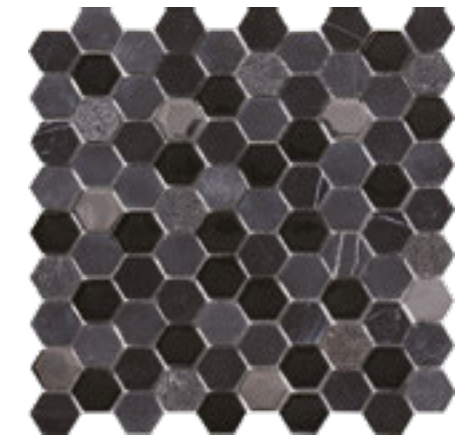

30,5x29,5cm

Cor: **Black**

Ref.: RMHEXABL

M185/259

M18.5/25.9



30,5x29,5cm

Cor: **Carrara White**

Ref.: RMHEXACW

M185/259

M18.5/25.9







Vidro, Pedra e Madre pérola  
Glass, stone and mother-of-pearl  
Verre, pierre et nacre / Glas, stein und pearlmutter  
Vidrio, piedra y madreperla



Colado em rede  
mesh mosaic / mosaïque collés sur trame  
mosaik auf netz geklebt / mosaico en malla



Mate e Brilho  
Matt and Gloss / Mat et brillant  
Matt und glanzend / Mate y Brillo



Interiores  
Indoors only / Intérieurs  
Nur drinnen / Solo en interiores



Variação Média V2  
Average tone variation / Variation moyenne  
Durchschnittliche Tonhöenschwankung  
Variación media de tono



Resistente ao gelo  
Frost resistant / Résistant au gel  
Frostbeständig / Resistente a las heladas



Espessura  
Thickness / Epaisseur / Dicke / Grosor



Requer cola para vidro  
Glass adhesive / Colle pour verre  
Kleber für Glas / Pegamento para vidrio



1 Pc  
0,09 m<sup>2</sup>  
1,57 Kg



11 Pcs  
1 m<sup>2</sup>  
17,20 Kg

# Agata



**M150/210**   
**M15/21**   
30x31,5cm  
Cor: **Shell Beige**  
Ref.: RMA15308B 5 606779 180223



**M150/210**   
**M15/21**   
30x31,5cm  
Cor: **Shell Grey**  
Ref.: RMA15308G 5 606779 180254



**M150/210**   
**M15/21**   
30x31,5cm  
Cor: **Shell Emperador**  
Ref.: RMA15308E 5 606779 180230



**M150/210**   
**M15/21**   
30x31,5cm  
Cor: **Shell Preto**  
Ref.: RMA15308P 5 606779 180247





Vidro, Pedra e Madre pérola  
 Glass, stone and mother-of-pearl  
 Verre, pierre et nacre / Glas, stein und pearlmutter  
 Vidrio, piedra y madreperla



Colado em rede  
 mesh mosaic / mosaïque collés sur trame  
 mosaik auf netz geklebt / mosaico en malla



Mate e Brilho  
 Matt and Gloss / Mat et brillant  
 Matt und glanzend / Mate y Brillo



Interiores  
 Indoors only / Intérieurs  
 Nur drinnen / Solo en interiores



Variação Média V2  
 Average tone variation / Variation moyenne  
 Durchschnittliche Tonhöhenchwankung  
 Variación media de tono



Resistente ao gelo  
 Frost resistant / Résistant au gel  
 Frostbeständig / Resistente a las heladas



Espessura  
 Thickness / Epaisseur / Dicke / Grosor



Requer cola para vidro  
 Glass adhesive / Colle pour verre  
 Kleber für Glas / Pegamento para vidrio



1 Pc  
 0,09 m<sup>2</sup>  
 1,46 Kg



11 Pcs  
 1 m<sup>2</sup>  
 17 Kg

# Most



30x30cm **M160/224**  
**M16/22.4**

Cor: **Shell Beige**

Ref.: RMMOSTSB

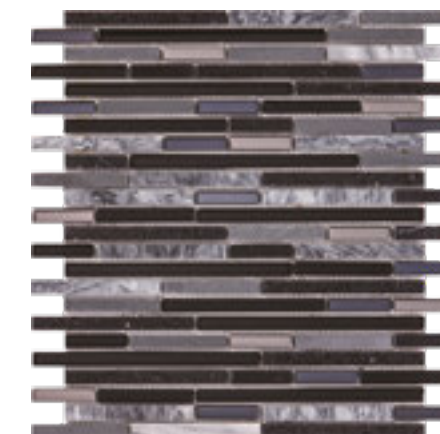

30x30cm **M160/224**  
**M16/22.4**

Cor: **Quartz Black**

Ref.: RMMOSTQB



30x30cm **M160/224**  
**M16/22.4**

Cor: **Quartz White**

Ref.: RMMOSTQW



30x30cm **M160/224**  
**M16/22.4**

Cor: **Mirror \***

Ref.: RMMOSTM



\* Só Vidro espelhado.  
Requer cola Superflex da Kerakoll



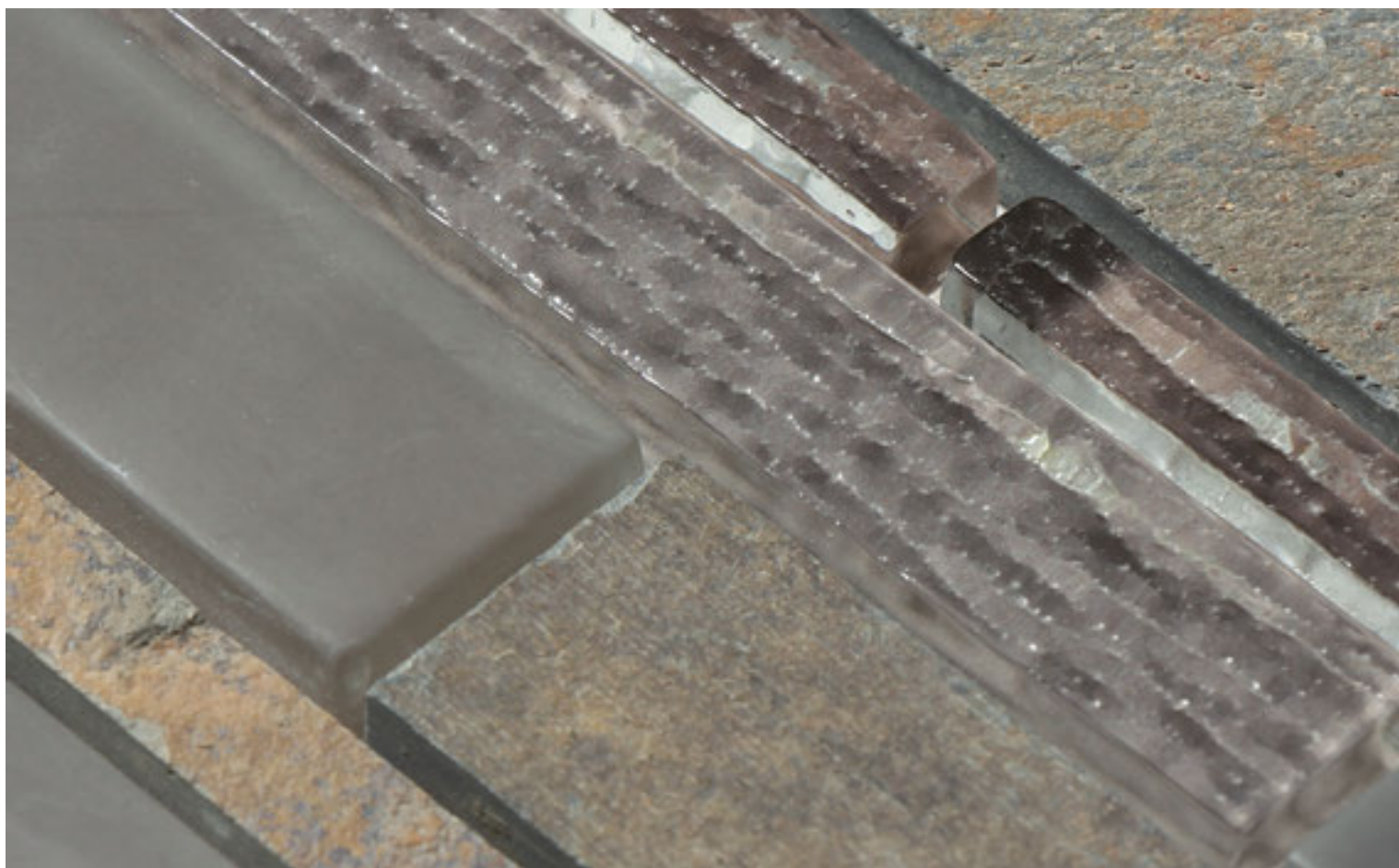

Vidro e Pedra  
 Glass and stone / Verre et pierre  
 Glas und Stein / Vidrio y Pedra



Colado em rede  
 mesh mosaic / mosaïque collés sur trame  
 mosaik auf netz geklebt / mosaico en malla



Mate e Brilho  
 Matt and Gloss / Mat et brillant  
 Matt und glänzend / Mate y Brillo



Interiores e Exteriores



Variação Média V2  
 Average tone variation / Variation moyenne  
 Durchschnittliche Tonhöhenchwankung  
 Variación media de tono



Resistente ao gelo  
 Frost resistant / Résistant au gel  
 Frostbeständig / Resistente a las heladas



Espessura  
 Thickness / Epaisseur / Dicke / Grosor



Requer cola para vidro  
 Glass adhesive / Colle pour verre  
 Kleber für Glas / Pegamento para vidrio



1 Pc  
 0,094m<sup>2</sup>  
 1,75 Kg



11 Pcs  
 1,04 m<sup>2</sup>  
 19,13 Kg

# Sabor



30,4x31,2cm **M150/210**

Cor: **Snow**

Ref.: RMSABORS



30,4x31,2cm **M150/210**

Cor: **Grafito**

Ref.: RMSABORG



# Jazz



30x30cm **M140/196**

Cor: **Brick**

Ref.: RMLAGS54



30x30cm **M140/196**

Cor: **Mini**

Ref.: RMLADS19





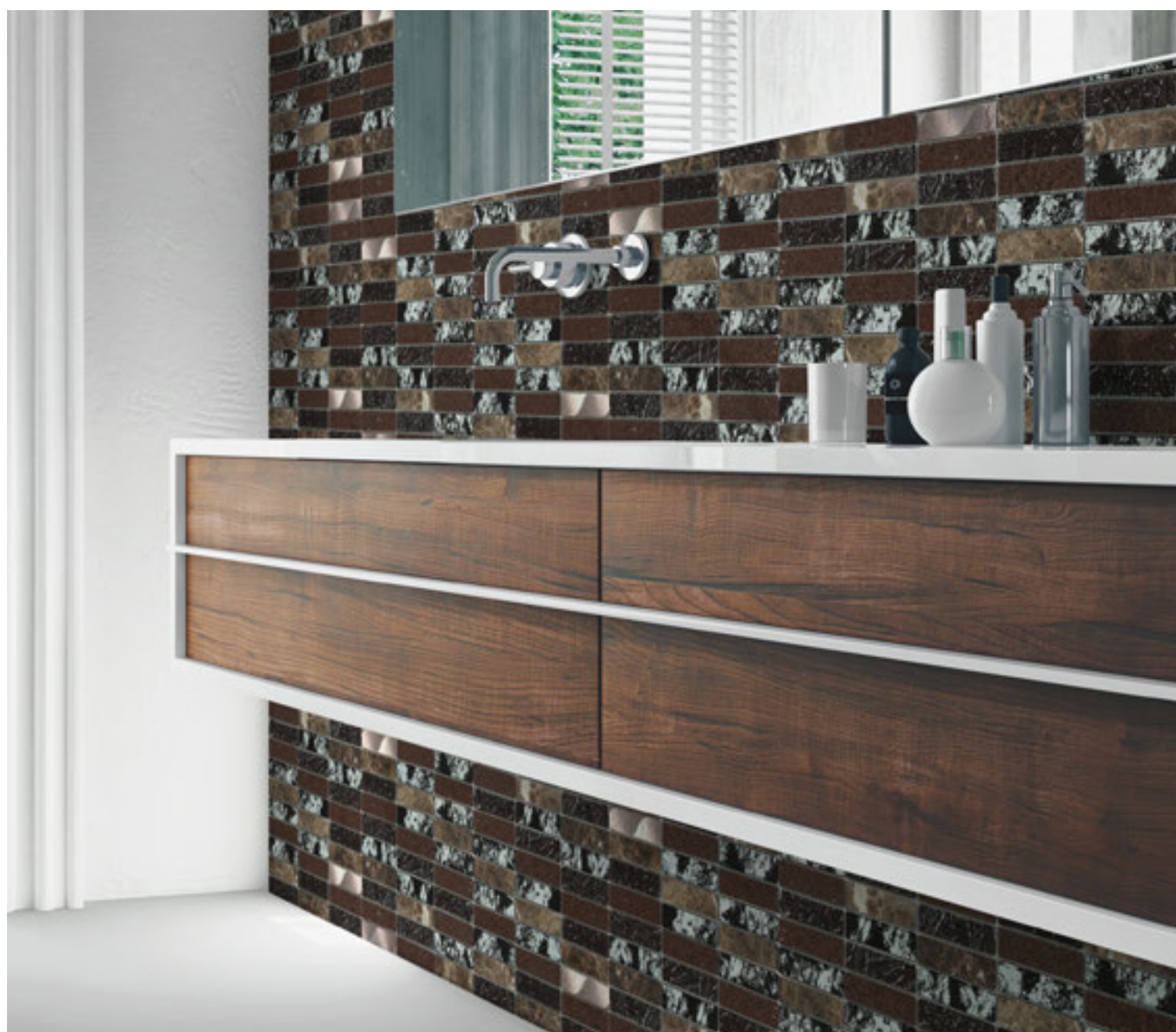

Vidro, Pedra e Madre pérola  
 Glass, stone and mother-of-pearl  
 Verre, pierre et nacre / Glas, stein und pearmuter  
 Vidrio, piedra y madreperla



Colado em rede  
 mesh mosaic / mosaïque collés sur trame  
 mosaik auf netz geklebt / mosaico en malla



Mate e Brilho  
 Matt and Gloss / Mat et brillant  
 Matt und glänzend / Mate y Brillo



Interiores  
 Indoors only / Intérieurs  
 Nur drinnen / Solo en interiores



Variação Média V2  
 Average tone variation / Variation moyenne  
 Durchschnittliche Tonhöhenchwankung  
 Variación media de tono



Resistente ao gelo  
 Frost resistant / Résistant au gel  
 Frostbeständig / Resistente a las heladas



Espessura  
 Thickness / Epaisseur / Dicke / Grosor



Requer cola para vidro  
 Glass adhesive / Colle pour verre  
 Kleber für Glas / Pegamento para vidrio



1 Pc  
 0,093 m<sup>2</sup>  
 1,59 Kg



11 Pcs  
 1,023 m<sup>2</sup>  
 17,30 Kg

# Dream



30x30cm **M170/238**  
**M17/23.8**  
 Cor: **Noce**  
 Ref.: RMDREAMNO



30x30cm **M170/238**  
**M17/23.8**  
 Cor: **Bianco**  
 Ref.: RMDREAMBI



# Punk

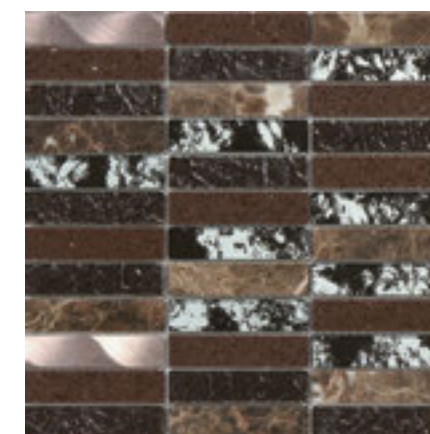

30x30cm **M125/175**  
**M12.5/17.5**  
 Cor: **Marron**  
 Ref.: RMPUNKM



30x30cm **M125/175**  
**M12.5/17.5**  
 Cor: **White**  
 Ref.: RMPUNKW







Vidro, Pedra e Madre pérola  
 Glass, stone and mother-of-pearl  
 Verre, pierre et nacre / Glas, stein und perlmutter  
 Vidrio, piedra y madreperla



Colado em rede  
 mesh mosaic / mosaïque collés sur trame  
 mosaik auf netz geklebt / mosaico en malla



Mate e Brilho  
 Matt and Glass / Mat et brillant  
 Matt und glanzend / Mate y Brillo



Interiores  
 Indoors only / Intérieurs  
 Nur drinnen / Solo en interiores



Variação Média V2  
 Average tone variation / Variation moyenne  
 Durchschnittliche Tonhöhenchwankung  
 Variación media de tono



Resistente ao gelo  
 Frost resistant / Résistant au gel  
 Frostbeständig / Resistente a las heladas



Espessura  
 Thickness / Epaisseur / Dicke / Grosor



Requer cola para vidro  
 Glass adhesive / Colle pour verre  
 Kleber für Glas / Pegamento para vidrio



PCS  
 1 Pc  
 0,09 m<sup>2</sup>  
 1,64 Kg



CX  
 11 Pcs  
 1 m<sup>2</sup>  
 18 Kg

# Kappa

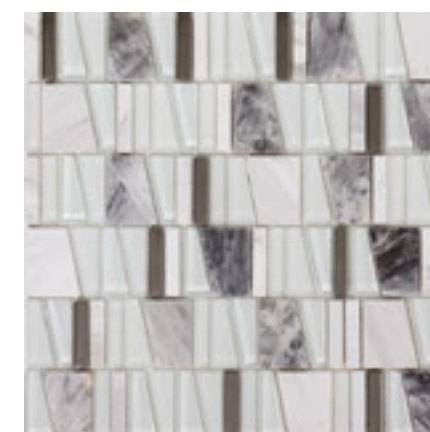

30x30cm **M175/245**  
**M17.5/24.5**

Cor: **White**

Ref.: RMKAPPAW



5 606779 180421

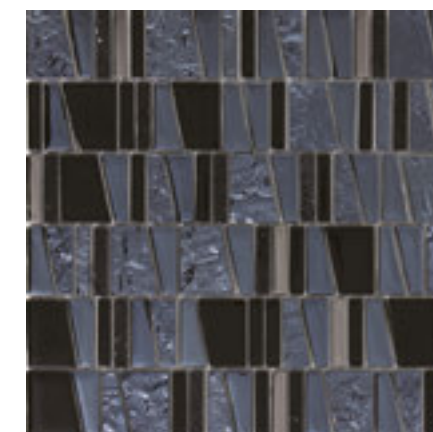

30x30cm **M175/245**  
**M17.5/24.5**

Cor: **Quartz Black**

Ref.: RMKAPPAQB



5 606779 180438

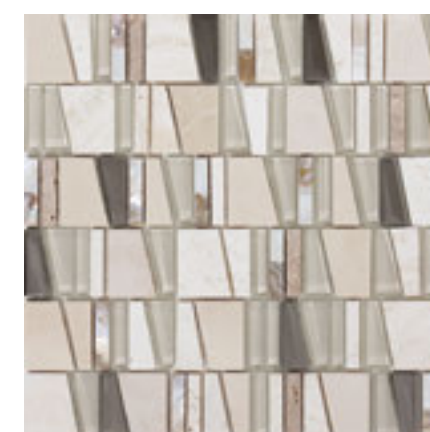

30x30cm **M175/245**  
**M17.5/24.5**

Cor: **Beige Shell \***

Ref.: RMKAPPABS



5 606779 165862

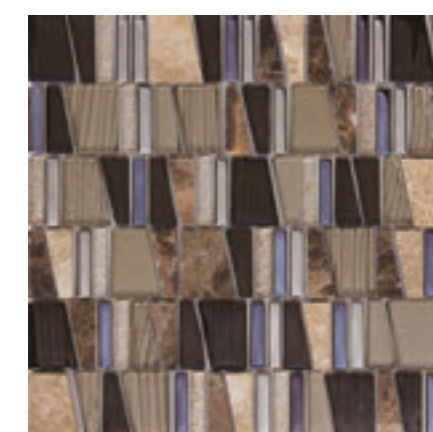

30x30cm **M175/245**  
**M17.5/24.5**

Cor: **Emperador**

Ref.: RMKAPPAE



5 606779 165879

\* Com peças em Madre Pérola





Vidro e Pedra  
 Glass and stone / Verre et pierre  
 Glas und Stein / Vidrio y Pedra



Colado em rede  
 mesh mosaic / mosaïque collés sur trame  
 mosaik auf netz geklebt / mosaico en malla



Mate e Brilha  
 Matt and Gloss / Mat et brillant  
 Matt und glänzend / Mate y Brillo



Interiores  
 Indoors only / Intérieurs  
 Nur drinnen / Solo en interiores



Variação Média V2  
 Average tone variation / Variation moyenne  
 Durchschnittliche Tonhöhenchwankung  
 Variación media de tono



Resistente ao gelo  
 Frost resistant / Résistant au gel  
 Frostbeständig / Resistente a las heladas



Espessura  
 Thickness / Epaisseur / Dicke / Grosor



Requer cola para vidro  
 Glass adhesive / Colle pour verre  
 Kleber für Glas / Pegamento para vidrio



PCS  
 1 Pc  
 0,09 m<sup>2</sup>  
 1,64 Kg



CX  
 11 Pcs  
 1 m<sup>2</sup>  
 18 Kg

# Matrix

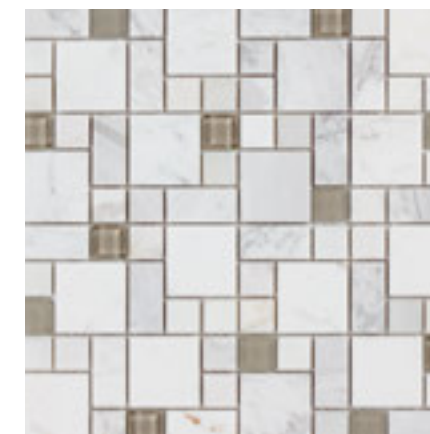

30x30cm

Cor: **Luminor White**

Ref.: RMMATRIXLW

M150/210

M15/21



5 606779 180452

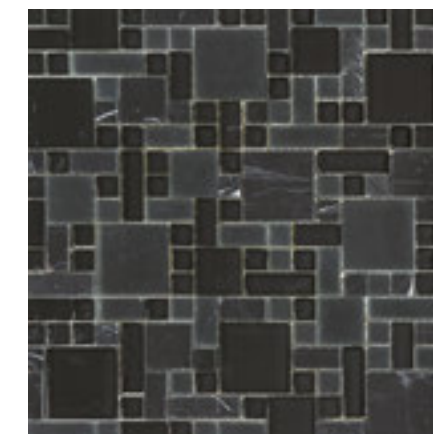

30x30cm

Cor: **Marquina**

Ref.: RMMATRIXM

M150/210

M15/21



5 606779 180445



30x30cm

Cor: **Emperador**

Ref.: RMMATRIXE

M150/210

M15/21



5 606779 180469





Vidro e Pedra  
Glass and stone / Verre et pierre  
Glas und Stein / Vidrio y Pedra



Colado em rede  
mesh mosaic / mosaïque collés sur trame  
mosaik auf netz geklebt / mosaico en malla



Mate e Brilho  
Matt and Gloss / Mat et brillant  
Matt und glanzend / Mate y Brillo



Interiores  
Indoors only / Intérieurs  
Nur drinnen / Solo en interiores



Variação Média V2  
Average tone variation / Variation moyenne  
Durchschnittliche Tonhöhenchwankung  
Variación media de tono



Resistente ao gelo  
Frost resistant / Résistant au gel  
Frostbeständig / Resistente a las heladas



Espessura  
Thickness / Épaisseur / Dicke / Grosor



Requer cola para vidro  
Glass adhesive / Colle pour verre  
Kleber für Glas / Pegamento para vidrio

PCS	RUSTIK	HEAVEN
1 Pc 0,09 m <sup>2</sup> 1,45 Kg	1 Pc 0,09 m <sup>2</sup> 1,54 Kg	1 Pc 0,093 m <sup>2</sup> 1,45 Kg
CX	CX	CX
11 Pcs 1 m <sup>2</sup> 16 Kg	11 Pcs 1 m <sup>2</sup> 17 Kg	11 Pcs 1,02 m <sup>2</sup> 16 Kg

# Royal & Old King

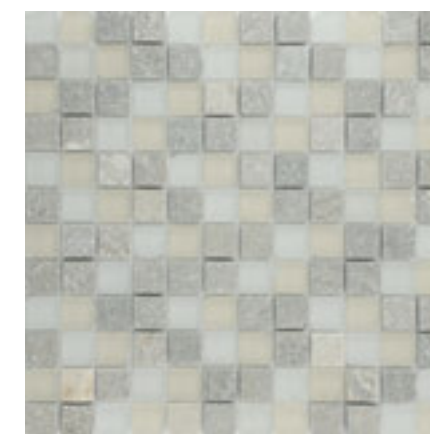

30x30cm  
Cor: **Royal**  
Ref.: RMLATM15

M140/196

M14/19.6

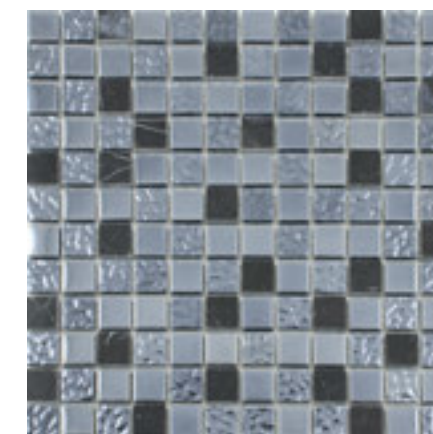

30x30cm  
Cor: **Luxo**  
Ref.: RMLAS63

M140/196

M14/19.6

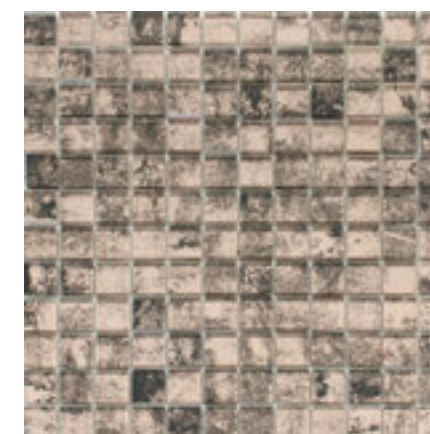

30x30cm - 8mm  
Cor: **Old King Cobre**  
Ref.: RMJXS202  
\* Só Vidro

M150/210

M15/21



30x30cm  
Cor: **Silk**  
Ref.: RMLP302  
\* Só Vidro

M140/196

M14/19.6



30x30cm  
Cor: **Rustik**  
Ref.: RMLAW12

M140/196

M14/19.6

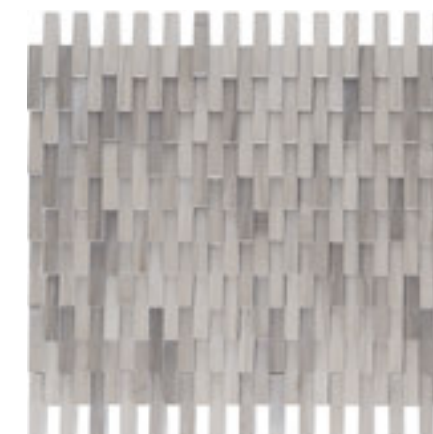

30x30cm  
Cor: **Dark**  
Ref.: RMY5281

M140/196

M14/19.6





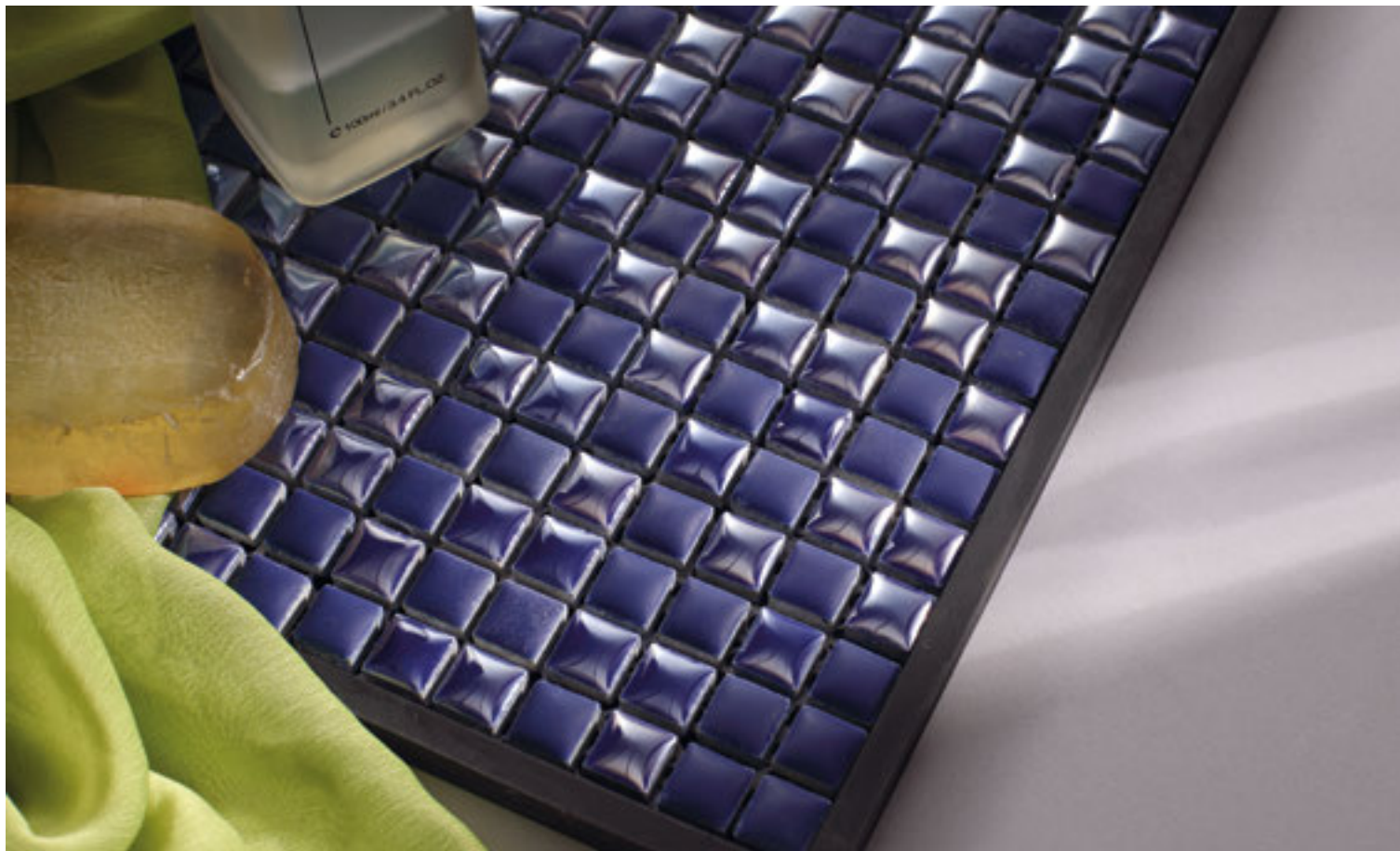

Cerâmica  
Ceramics / Céramique  
Keramik / Cerámica



Colado em rede  
mesh mosaic / mosaïque collés sur trame  
mosaik auf netz geklebt / mosaico en malla



Mate e Brilho  
Matt and Gloss / Mat et brillant  
Matt und glänzend / Mate y Brillo



Interior e exteriores  
Indoors and Outdoors /



Variação Média V2  
Average tone variation / Variation moyenne  
Durchschnittliche Tonhöhenchwankung  
Variación media de tono



Resistente ao gelo  
Frost resistant / Résistant au gel  
Frostbeständig / Resistente a las heladas



Espessura  
Thickness / Épaisseur / Dicke / Grosor



Cola para porcelânicos  
Porcelain Adhesive / Colle pour grès cérame  
Kleber für Porzellanfliesen / Pegamento para porcelánico



PCS  
1 Pc  
0,09 m<sup>2</sup>  
1,54 Kg



CX  
11 Pcs  
1 m<sup>2</sup>  
17 Kg

# Classic

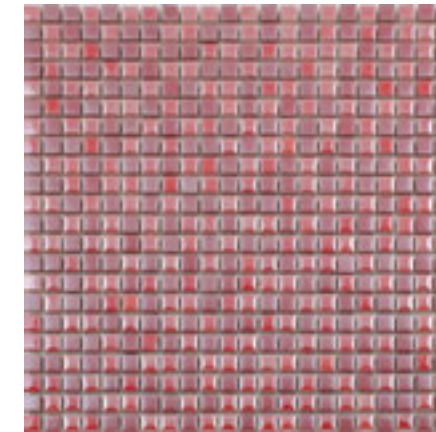

30x30cm **M130/182**  
Cor: **Red**  
Ref.: RMGAHS16

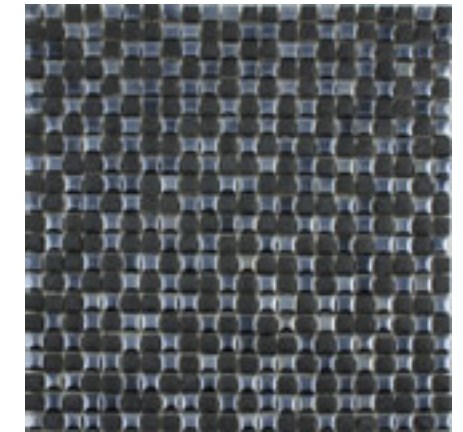

30x30cm **M130/182**  
Cor: **Preto**  
Ref.: RMGFHS13

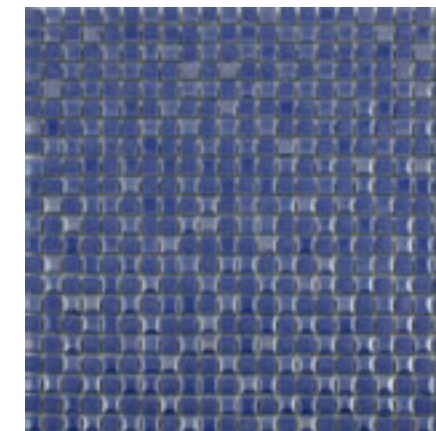

30x30cm **M130/182**  
Cor: **Azul**  
Ref.: RMGFHS18

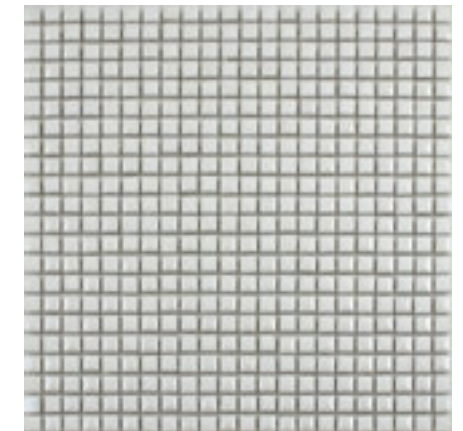

30x30cm **M130/182**  
Cor: **Branco**  
Ref.: RMGFHS11

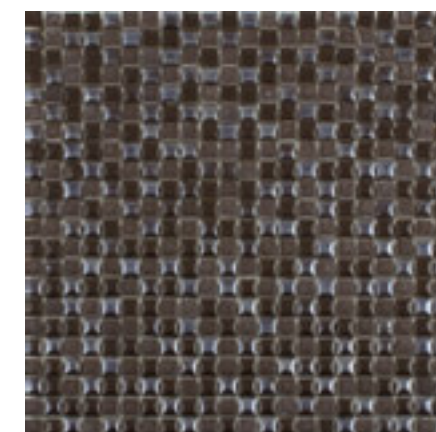

30x30cm **M130/182**  
Cor: **Castanho**  
Ref.: RMGFHS02







Cerâmica  
Ceramics / Céramique  
Keramik / Cerámica



Colado em rede  
mesh mosaic / mosaïque collés sur trame  
mosaik auf netz geklebt / mosaico en malla



Mate e Brilho  
Matt and Gloss / Mat et brillant  
Matt und glänzend / Mate y Brillo



Interior e exteriores  
Indoors and Outdoors /



Variação Média V2  
Average tone variation / Variation moyenne  
Durchschnittliche Tonhöhenchwankung  
Variación media de tono



Resistente ao gelo  
Frost resistant / Résistant au gel  
Frostbeständig / Resistente a las heladas



Espessura  
Thickness / Epaisseur / Dicke / Grosor



Cola para porcelânicos  
Porcelain Adhesive / Colle pour grès cérame  
Kleber für Porzellanfliesen / Pegamento para porcelánico

<b>FLARE</b>	<b>PRECIOS</b>
1 Pc	1 Pc
0,09 m <sup>2</sup>	0,09 m <sup>2</sup>
0,81 Kg	0,81 Kg

<b>CX</b>	<b>CX</b>
11 Pcs	18 Pcs
1 m <sup>2</sup>	1,64 m <sup>2</sup>
9 Kg	15 Kg

# Precious & Flare



30x30cm **M100/140**

Cor: **Precious Prata**

Ref.: RMBT2586

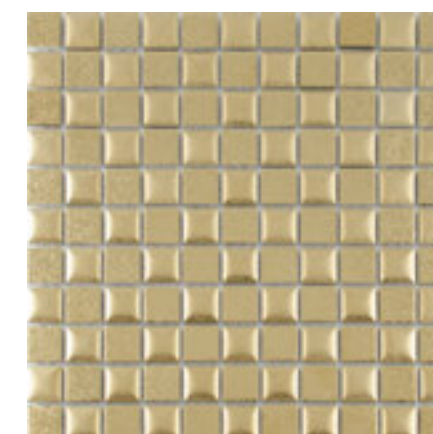

30x30cm **M100/140**

Cor: **Precious Gold**

Ref.: RMAT2586



30x30cm **M85/119**

Cor: **Flare Mate**

Ref.: RB2502

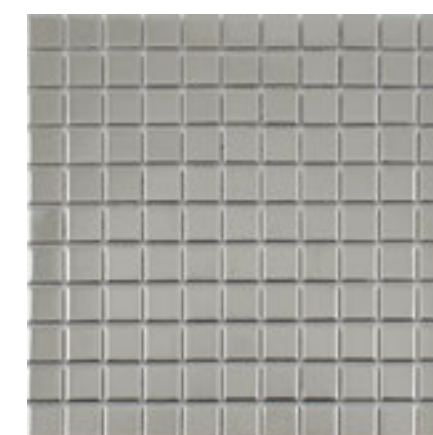

30x30cm **M85/119**

Cor: **Flare Brilho**

Ref.: RB2501





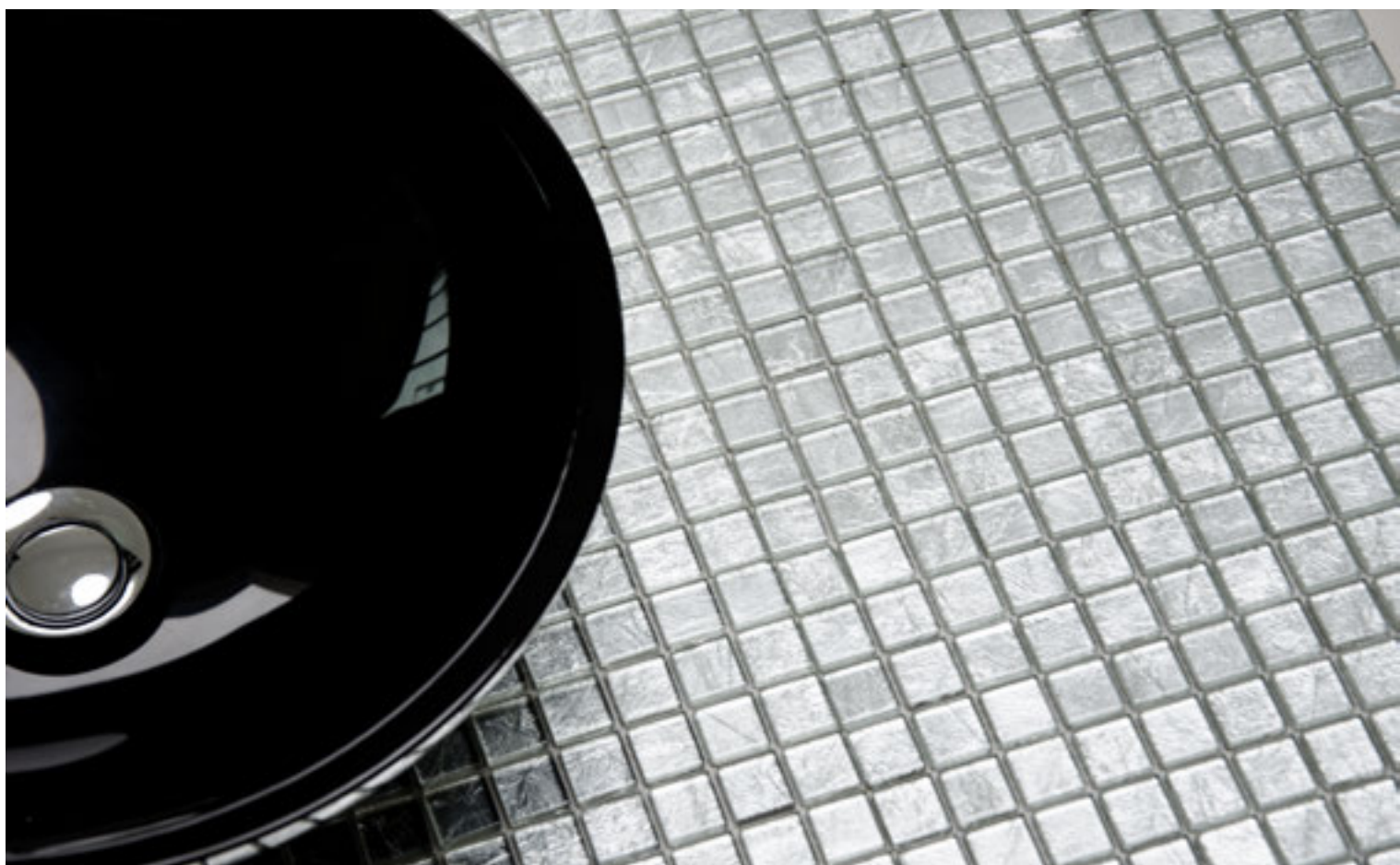

Vidro  
Glass / Verre / Vidrio / Glas



Colado em rede  
mesh mosaic / mosaïque collés sur trame  
mosaik auf netz geklebt / mosaico en malla



Brilho  
Glass / Brillant / Glanz / Brillo



Interiores  
Indoors only / Intérieurs  
Nur drinnen / Solo en interiores



Variação Média V2  
Average tone variation / Variation moyenne  
Durchschnittliche Tonhöhenchwankung  
Variación media de tono



Resistente ao gelo  
Frost resistant / Résistant au gel  
Frostbeständig / Resistente a las heladas



Espessura  
Thickness / Epaisseur / Dicke / Grosor



Requer cola para vidro  
Glass adhesive / Colle pour verre  
Kleber für Glas / Pegamento para vidrio

SILVER BROKEN	RETRO	METALIC
1 Pc	1 Pc	1 Pc
0,09 m <sup>2</sup>	0,09 m <sup>2</sup>	0,09 m <sup>2</sup>
1,35 Kg	1,35 Kg	1,35 Kg

CX	CX	CX
11 Pcs	16 Pcs	14 Pcs
1 m <sup>2</sup>	1,44 m <sup>2</sup>	1,27 m <sup>2</sup>
15 Kg	22 Kg	20 Kg

# Glam

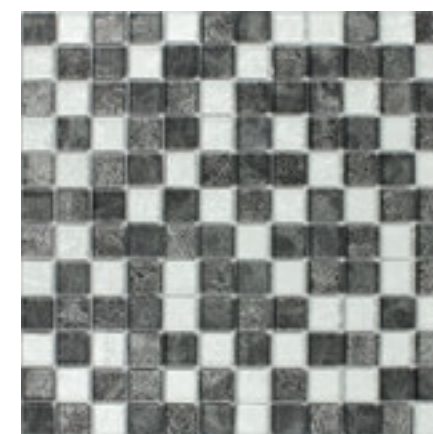

30x30cm **M125/175**

Cor: **Retro**

Ref.: RB2301DB



30x30cm **M125/175**

Cor: **Silver**

Ref.: RB2301YB

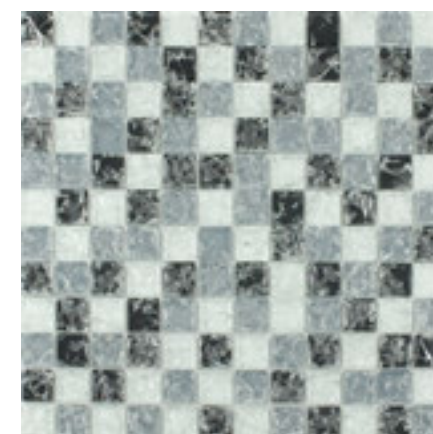

30x30cm **M125/175**

Cor: **Broken**

Ref.: RR2303C

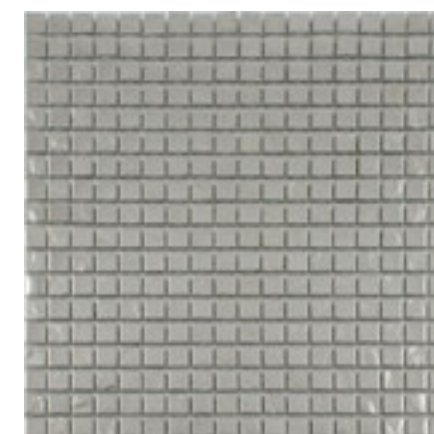

30x30cm **M125/175**

Cor: **Metalic**

Ref.: RB156ZP







Vidro  
Glass / Verre / Vidrio / Glas



Colado em rede  
mesh mosaic / mosaïque collés sur trame  
mosaik auf netz geklebt / mosaico en malla



Brilho  
Glass / Brillant / Glanz / Brillo



Interiores  
Indoors only / Intérieurs  
Nur drinnen / Solo en interiores



Variação Média V2  
Average tone variation / Variation moyenne  
Durchschnittliche Tonhöhenchwankung  
Variación media de tono



Resistente ao gelo  
Frost resistant / Résistant au gel  
Frostbeständig / Resistente a las heladas



Espessura  
Thickness / Epaisseur / Dicke / Grosor



Requer cola para vidro  
Glass adhesive / Colle pour verre  
Kleber für Glas / Pegamento para vidrio

ONDA	BEYOND	LADY
1 Pc 0,09 m <sup>2</sup> 1,75 Kg	1 Pc 0,09 m <sup>2</sup> 1,54 Kg	1 Pc 0,09 m <sup>2</sup> 0,85 Kg
<b>CX</b>	<b>CX</b>	<b>CX</b>
11 Pcs 1 m <sup>2</sup> 20 Kg	11 Pcs 1 m <sup>2</sup> 17 Kg	22 Pcs 1,98 m <sup>2</sup> 18,7 Kg

## Beyond



**30x30cm**  
Cor: **Gold**  
Ref.: RMJP7313

**M130/182**  
**M13/18.2**



## Onda

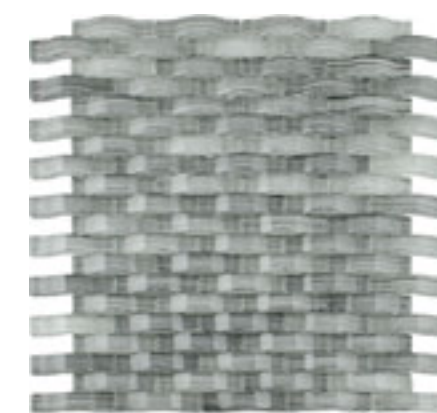

**30x32,5cm**  
Cor: **Onda Grey**  
Ref.: RAO08DW

**M120/168**  
**M12/16.8**



## Lady



**30x30cm - 4mm**  
Cor: **Cobre**  
Ref.: RMLAD12

**M95/133**  
**M9,5/13.3**



**30x30cm - 4mm**  
Cor: **Prata**  
Ref.: RMLAD11

**M95/133**  
**M9,5/13.3**



Pastilha Lady requer cola Superflex da Keracoll  
Lady Mosaics require Keracoll Superflex adhesives / La mosaïque Lady preconise l'utilisation de la colle Superflex da Keracoll  
"Lady"-Mosaik benötigen Keracoll Superflex-Kleber / Los mosaicos Lady requieren pegamento Keracoll Superflex





Vidro  
Glass / Verre / Vidrio / Glas



Colado em rede  
mesh mosaic / mosaïque collés sur trame  
mosaik auf netz geklebt / mosaico en malla



Brilho  
Glass / Brillant / Glanz / Brillo



Interiores  
Indoors only / Intérieurs  
Nur drinnen / Solo en interiores



Variação Média V2  
Average tone variation / Variation moyenne  
Durchschnittliche Tonhöhenchwankung  
Variación media de tono



Resistente ao gelo  
Frost resistant / Résistant au gel  
Frostbeständig / Resistente a las heladas



Espessura  
Thickness / Epaisseur / Dicke / Grosor



Requer cola para vidro  
Glass adhesive / Colle pour verre  
Kleber für Glas / Pegamento para vidrio

FLASH	GLIMPSE	OVAL
1 Pc	1 Pc	1 Pc
0,087m <sup>2</sup>	0,087 m <sup>2</sup>	0,081 m <sup>2</sup>
1,6 Kg	1,60 Kg	1,60 Kg
<b>CX</b>	<b>CX</b>	<b>CX</b>
10 Pcs	10 Pcs	10 Pcs
0,87 m <sup>2</sup>	0,87 m <sup>2</sup>	1 m <sup>2</sup>
16 Kg	16 Kg	16 Kg

# Flash

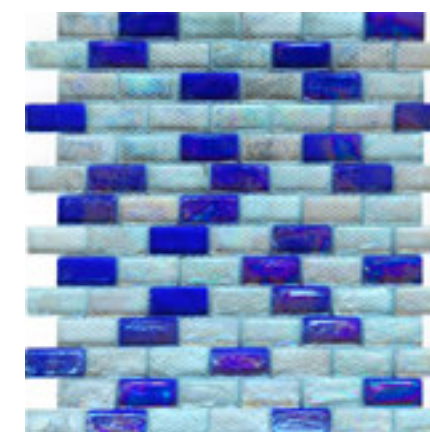

**M85/119**

28,5x30,5cm **M8.5/11.9**

Cor: **Blue**

Ref.: RMIBR010402

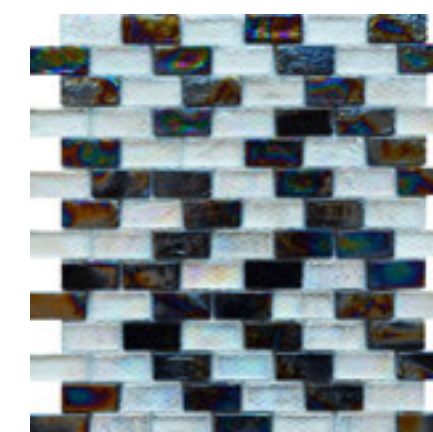

**M85/119**

28,5x30,5cm **M8.5/11.9**

Cor: **Prt/Brc**

Ref.: RMIBR0106

# Glimpse

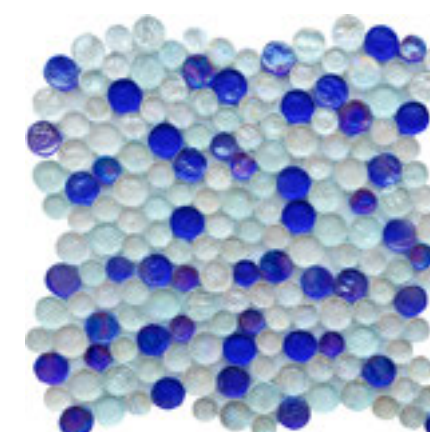

**M85/119**

29,5x29,5cm **M8.5/11.9**

Cor: **Blue**

Ref.: RM010204

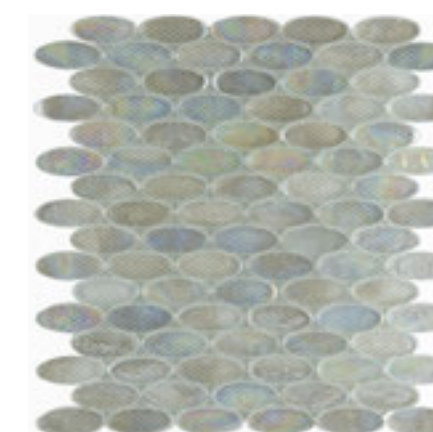

**M85/119**

28x29cm **M8.5/11.9**

Cor: **Glimpse Oval**

Ref.: RMIOV01



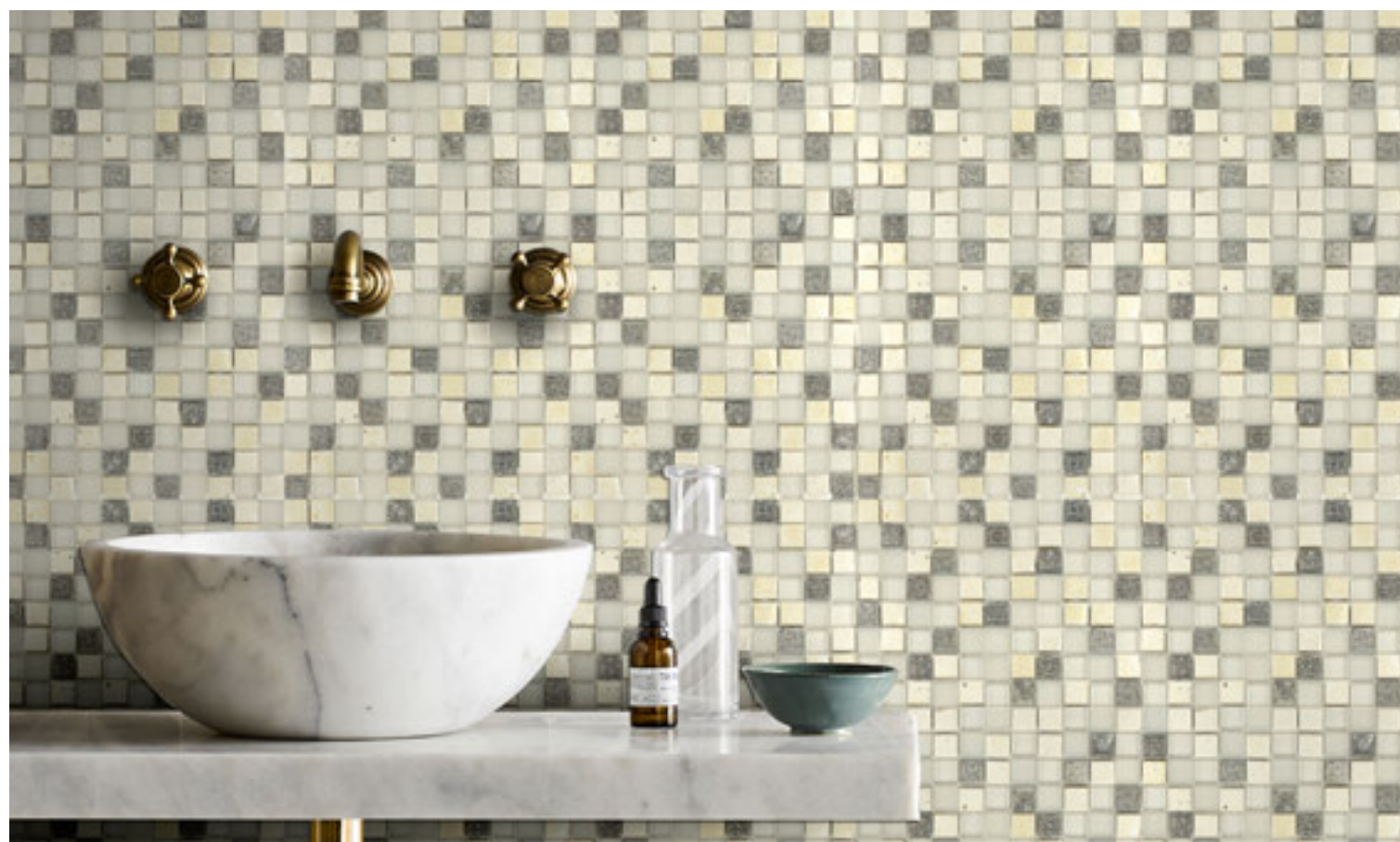
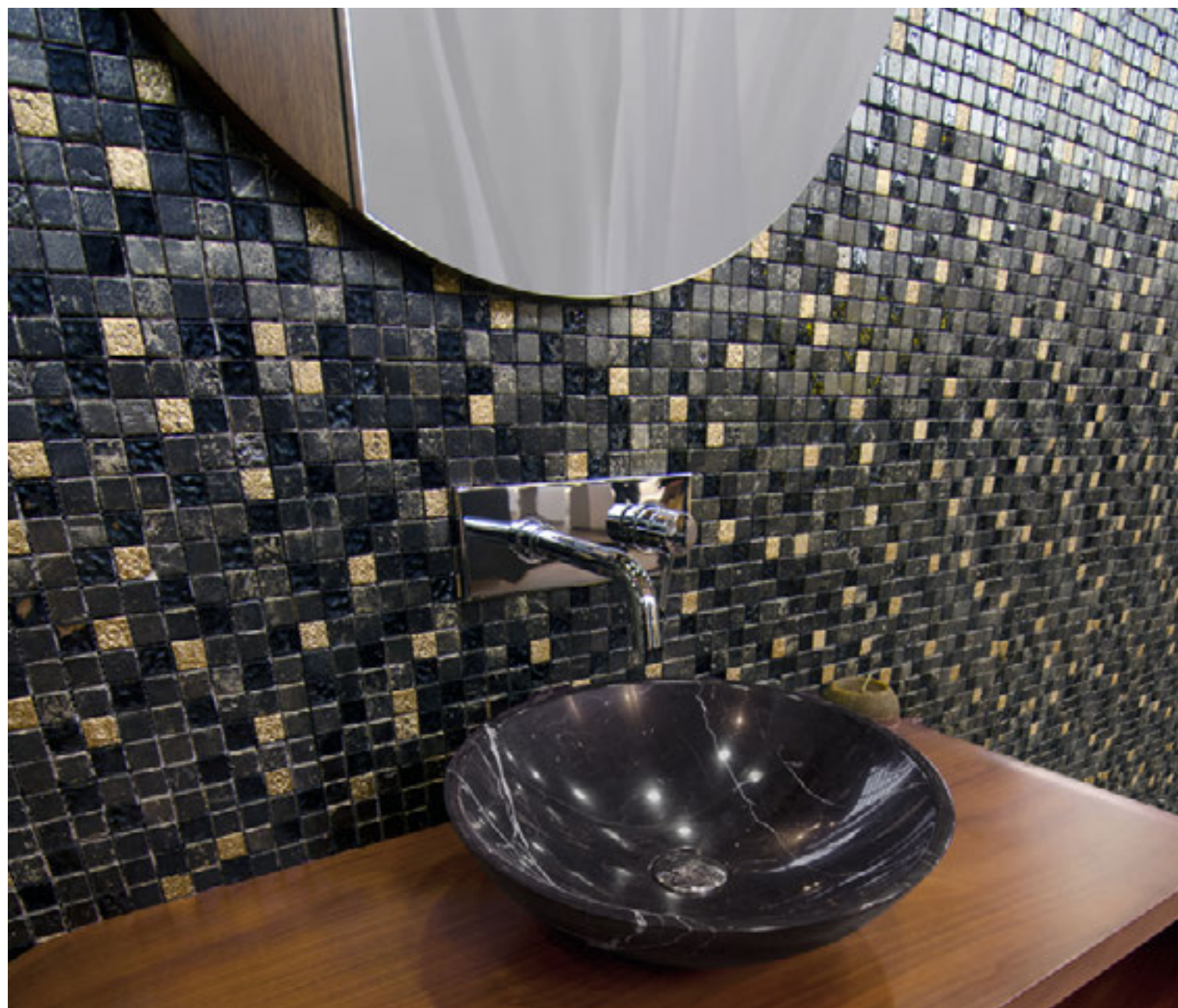

Vidro e Pedra  
 Glass and stone / Verre et pierre  
 Glas und Stein / Vidrio y Pedra



Colado em rede  
 mesh mosaic / mosaïque collés sur trame  
 mosaik auf netz geklebt / mosaico en malla



Mate e Brilho  
 Matt and Gloss / Mat et brillant  
 Matt und glänzend / Mate y Brillo



Interiores  
 Indoors only / Intérieurs  
 Nur drinnen / Solo en interiores



Variação Média V2  
 Average tone variation / Variation moyenne  
 Durchschnittliche Tonhöhenchwankung  
 Variación media de tono



Resistente ao gelo  
 Frost resistant / Résistant au gel  
 Frostbeständig / Resistente a las heladas



Espessura  
 Thickness / Epaisseur / Dicke / Grosor



Requer cola para vidro  
 Glass adhesive / Colle pour verre  
 Kleber für Glas / Pegamento para vidrio



1 Pc  
 0,09 m<sup>2</sup>  
 1,54 Kg



11 Pcs  
 1 m<sup>2</sup>  
 17 Kg

\* RMBDA2323, RMBDA97, RMBDA84 e RMBDA52 - Não usar na área de duche

# Vogue



30x30cm **M140/196**

Cor: **Metalic Bege**

Ref.: RMBDA2323



30x30cm **M140/196**

Cor: **Mix Gold**

Ref.: RMBDA97



30x30cm **M140/196**

Cor: **Dourado**

Ref.: RMBDA84



30x30cm **M140/196**

Cor: **Bege**

Ref.: RMBDA52







Vidro e Pedra  
 Glass and stone / Verre et pierre  
 Glas und Stein / Vidrio y Pedra



Colado em rede  
 mesh mosaic / mosaïque collés sur trame  
 mosaik auf netz geklebt / mosaico en malla



Mate e Brilho  
 Matt and Gloss / Mat et brillant  
 Matt und glänzend / Mate y Brillo



Interiores  
 Indoors only / Intérieurs  
 Nur drinnen / Solo en interiores



Variação Média V2  
 Average tone variation / Variation moyenne  
 Durchschnittliche Tonhöhenchwankung  
 Variación media de tono



Resistente ao gelo  
 Frost resistant / Résistant au gel  
 Frostbeständig / Resistente a las heladas



Espessura  
 Thickness / Épaisseur / Dicke / Grosor



Requer cola para vidro  
 Glass adhesive / Colle pour verre  
 Kleber für Glas / Pegamento para vidrio



PCS  
 1 Pc  
 0,09 m<sup>2</sup>  
 1,54 Kg



CX  
 11 Pcs  
 1 m<sup>2</sup>  
 17 Kg

\* RMBDA2346, RMBDA38 e RMBDA84 - Não usar na área de duche

# Vogue



30x30cm **M140/196**  
 **M14/19.6**  
 Cor: **Cinza**  
 Ref: RMBDA2346



30x30cm **M140/196**  
 **M14/19.6**  
 Cor: **White & Silver**  
 Ref: RMBDA38

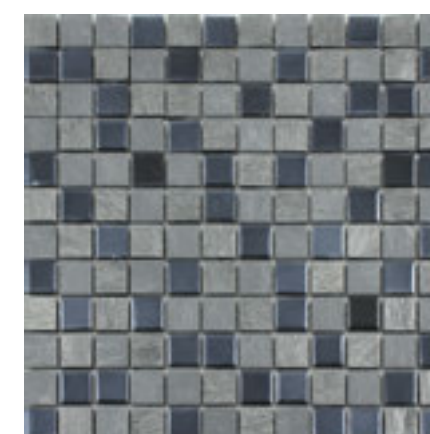

30x30cm **M140/196**  
 **M14/19.6**  
 Cor: **Black**  
 Ref: RMS230L

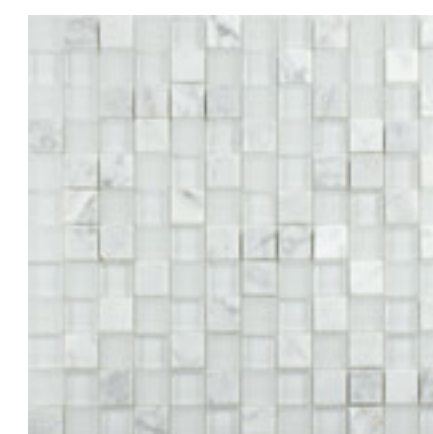

30x30cm **M140/196**  
 **M14/19.6**  
 Cor: **White Marble**  
 Ref: RMGMBD201

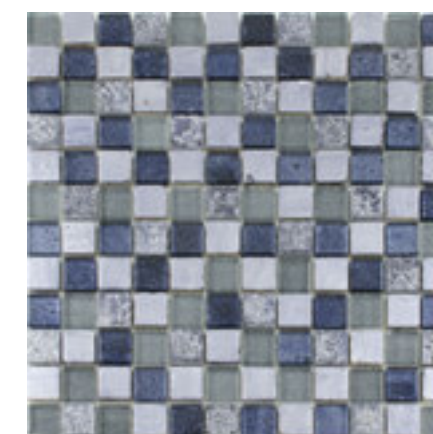

30x30cm **M150/210**  
 **M15/21**  
 Cor: **Blue Jeans**  
 Ref: RMBDA2305





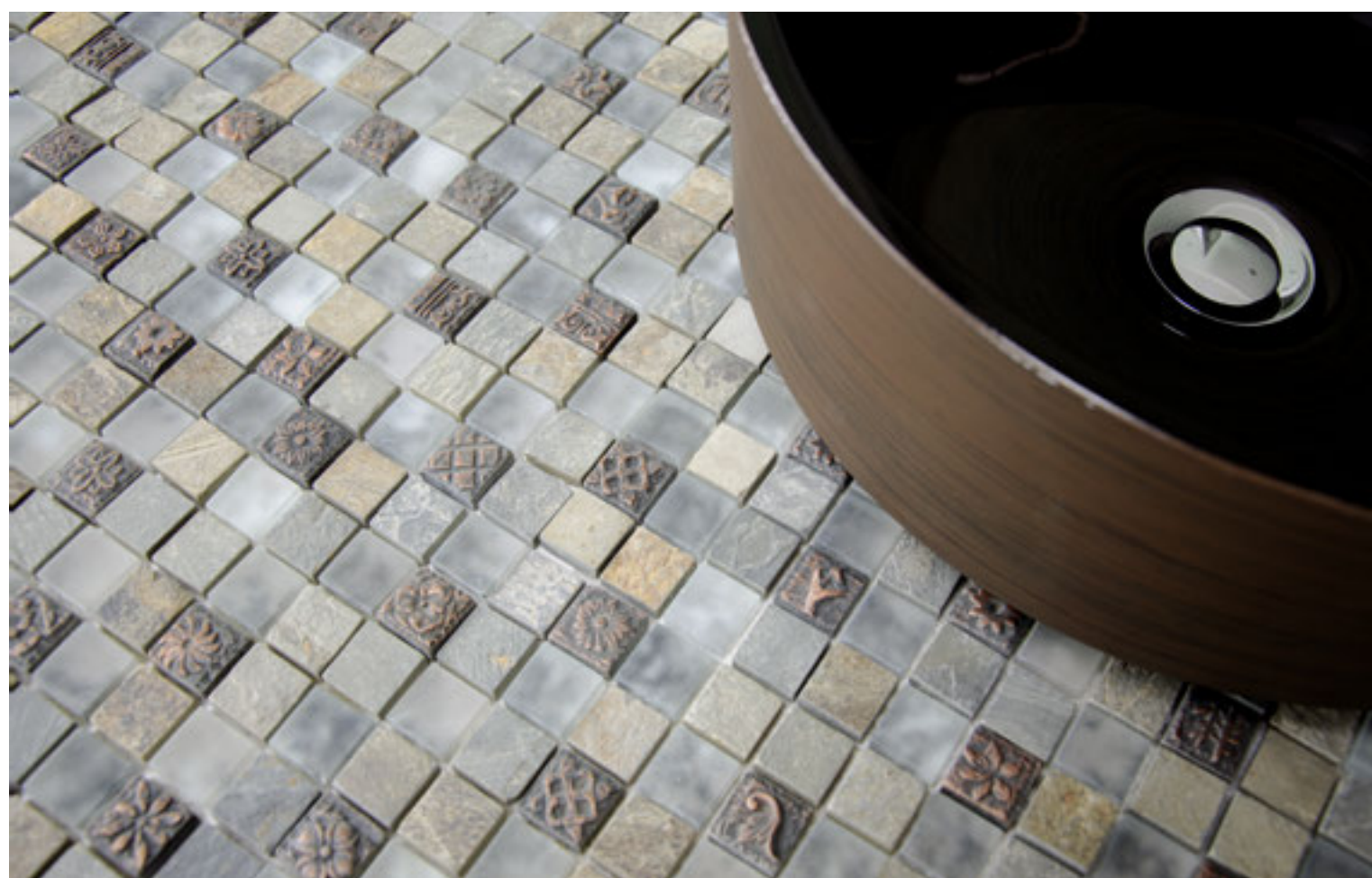

Vidro e Pedra  
 Glass and stone / Verre et pierre  
 Glas und Stein / Vidrio y Pedra



Colado em rede  
 mesh mosaic / mosaïque collés sur trame  
 mosaik auf netz geklebt / mosaico en malla



Mate e Brilho  
 Matt and Gloss / Mat et brillant  
 Matt und glänzend / Mate y Brillo



Interiores  
 Indoors only / Intérieurs  
 Nur drinnen / Solo en interiores



Variação Média V2  
 Average tone variation / Variation moyenne  
 Durchschnittliche Tonhöhenchwankung  
 Variación media de tono



Resistente ao gelo  
 Frost resistant / Résistant au gel  
 Frostbeständig / Resistente a las heladas



Espessura  
 Thickness / Epaisseur / Dicke / Grosor



Requer cola para vidro  
 Glass adhesive / Colle pour verre  
 Kleber für Glas / Pegamento para vidrio



PCS  
 1 Pc  
 0,09 m<sup>2</sup>  
 1,54 Kg



CX  
 11 Pcs  
 1 m<sup>2</sup>  
 17 Kg

\* RMBDA82, RMS2301, RMBDA03C e RMBDA04 - Não usar na área de duche

# Vogue



30x30cm **M150/210**

Cor: **Travertino**

Ref.: RMBDA03C



30x30cm **M140/196**

Cor: **Caramelo**

Ref.: RMS2301



30x30cm **M140/196**

Cor: **Castanho**

Ref.: RMBDA82



30x30cm **M140/196**

Cor: **Cinza**

Ref.: RMBDA04







Cerâmica  
Ceramics / Céramique  
Keramik / Cerámica



Colado em rede  
mesh mosaic / mosaïque collés sur trame  
mosaik auf netz geklebt / mosaico en malla



Mate e Brilho  
Matt and Gloss / Mat et brillant  
Matt und glänzend / Mate y Brillo



Interiores  
Indoors only / Intérieurs  
Nur drinnen / Solo en interiores



Variação Média V2  
Average tone variation / Variation moyenne  
Durchschnittliche Tonhöhenchwankung  
Variación media de tono



Resistente ao gelo  
Frost resistant / Résistant au gel  
Frostbeständig / Resistente a las heladas



Espessura  
Thickness / Épaisseur / Dicke / Grosor



Cola para porcelânicos  
Porcelain Adhesive / Colle pour grès cérame  
Kleber für Porzellanfliesen / Pegamento para porcelánico



PCS  
1 Pc  
0,09 m<sup>2</sup>  
1,54 Kg



CX  
11 Pcs  
1 m<sup>2</sup>  
17 Kg

# Amaze

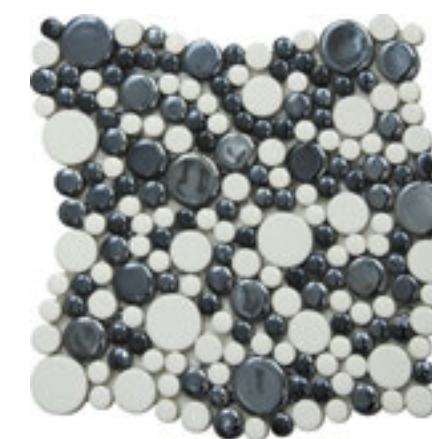

30x30cm **M150/210**

Cor: **P&B** **M15/21**

Ref.: RMGOHS001

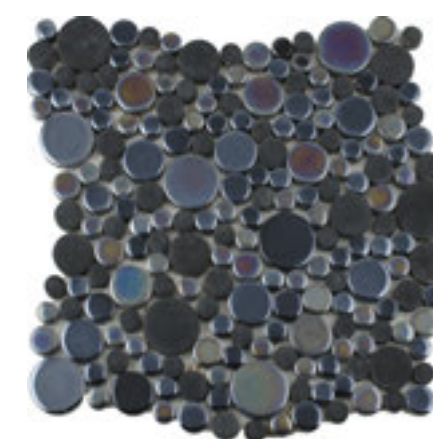

30x30cm **M150/210**

Cor: **Preto** **M15/21**

Ref.: RMGOHS006

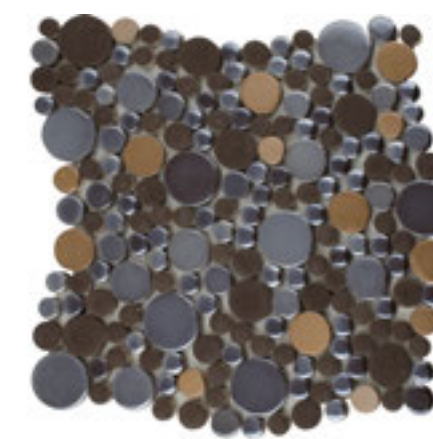

30x30cm **M150/210**

Cor: **Cooper** **M15/21**

Ref.: RMOHS309



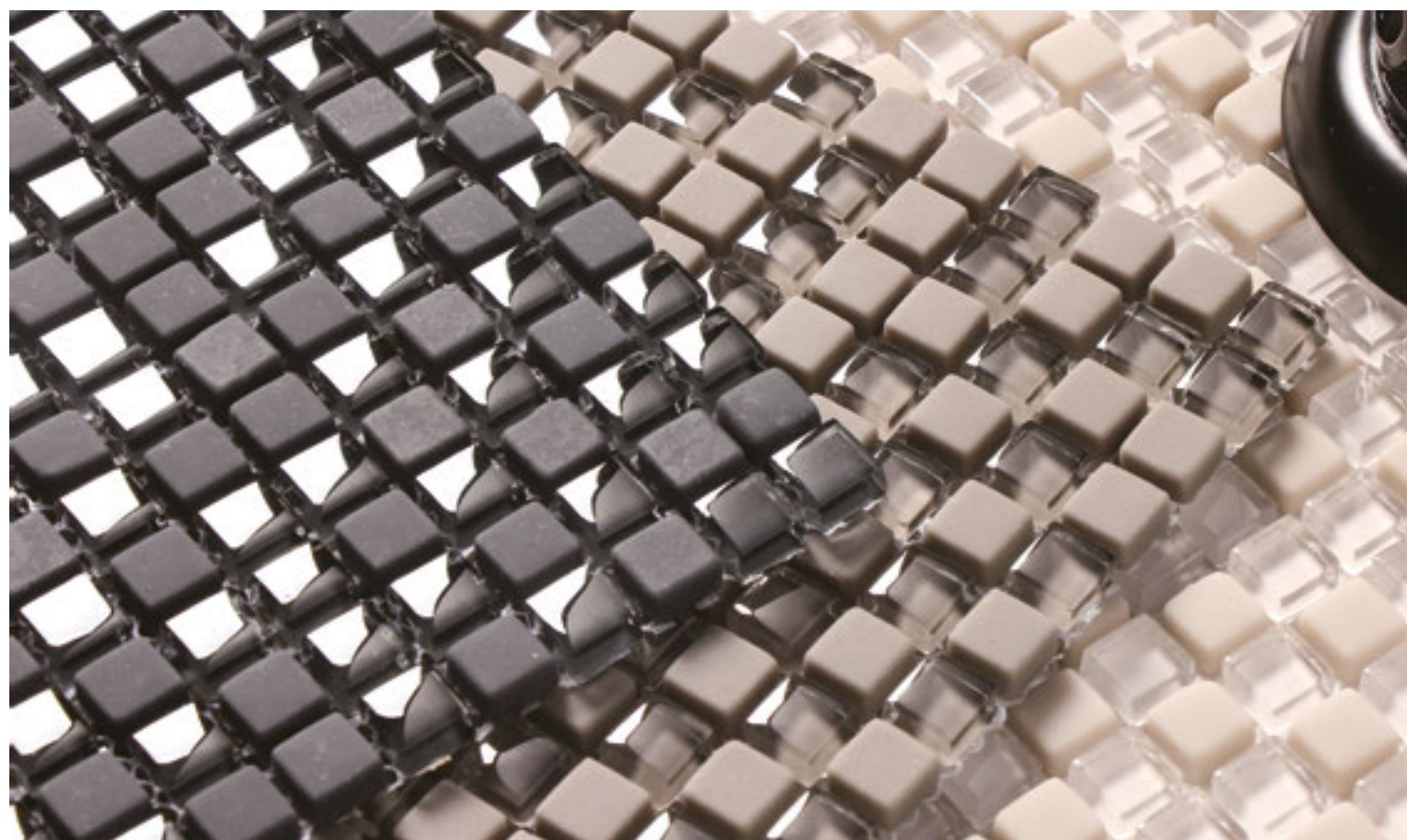

Vidro  
Glass / Verre / Vidrio / Glas



Colado em rede  
mesh mosaic / mosaïque collés sur trame  
mosaik auf netz geklebt / mosaico en malla



Mate e Brilho  
Matt and Gloss / Mat et brillant  
Matt und glanzend / Mate y Brillo



Interiores  
Indoors only / Intérieurs  
Nur drinnen / Solo en interiores



Variação Média V2  
Average tone variation / Variation moyenne  
Durchschnittliche Tonhöhenchwankung  
Variación media de tono



Resistente ao gelo  
Frost resistant / Résistant au gel  
Frostbeständig / Resistente a las heladas



Espessura  
Thickness / Epaisseur / Dicke / Grosor



Requer cola para vidro  
Glass cement / Ciment pour verre  
Kleber für Glas / Cemento para vidrio



1 Pc  
0,09 m<sup>2</sup>  
0,95 Kg



15 Pcs  
1,35 m<sup>2</sup>  
14 Kg

# Nani

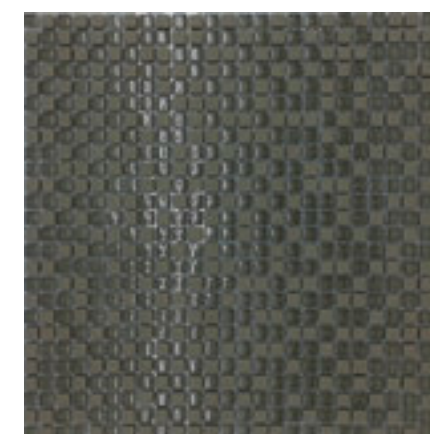

30x30cm **M145/203**

Cor: **Grey**  
Ref.: RMNANIGREY

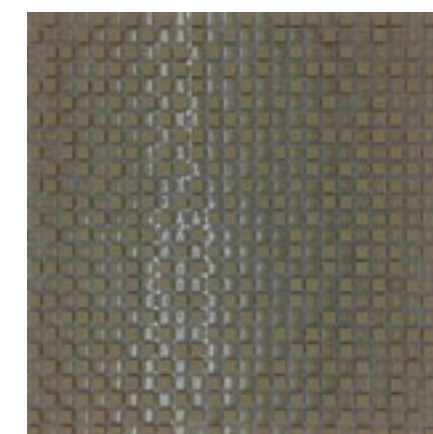

30x30cm **M145/203**

Cor: **Tortora**  
Ref.: RMNANITOR-TORA

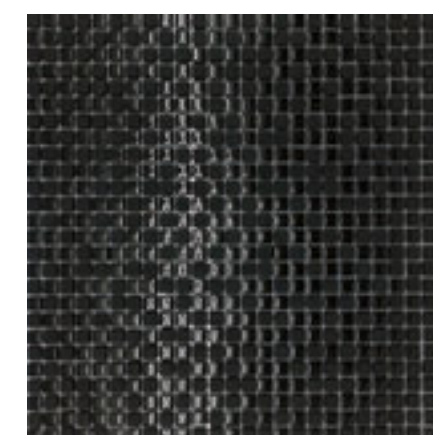

30x30cm **M145/203**

Cor: **Black**  
Ref.: RMNANIBLACK







Vidro  
Glass / Verre / Vidrio / Glas



Colado em rede  
Mesh mosaic / Mosaïque collés sur trame  
Mosaik auf netz geklebt / Mosaico en malla



Brilho  
Glass / Brillant / Glanz / Brillo



Interiores e Exteriores  
Indoors and outdoors / Intérieurs et extérieurs  
Drinnen und draußen / Interior y exterior



Variação Média V1  
Average tone variation / Variation moyenne  
Durchschnittliche Tonhöhenchwankung  
Variación media de tono



Resistente ao gelo  
Frost resistant / Résistant au gel  
Frostbeständig / Resistente a las heladas



Espessura  
Thickness / Epaisseur / Dicke / Grosor



Requer cola para Vidro  
Glass cement / Ciment pour verre  
Glaskleber / Cemento para vidrio



Adequado a piscinas  
Suitable for pools / Adapté aux piscines  
Geeignet für Pools / Apto para piscinas



PCS  
1 Pc  
0,107 m<sup>2</sup>  
0,77 Kg



CX  
20 Pcs  
2,14 m<sup>2</sup>  
15,30 Kg

# Symphony

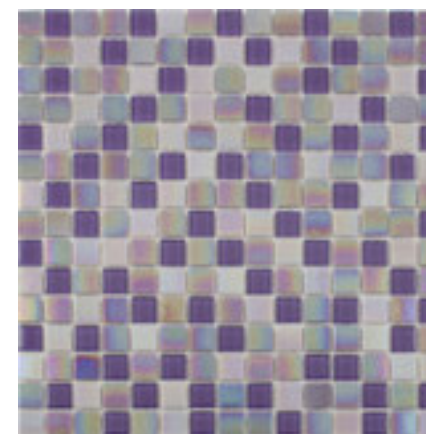

M40/56

32,7x32,7cm

M5/7

Cor: **York**

Ref.: RM02

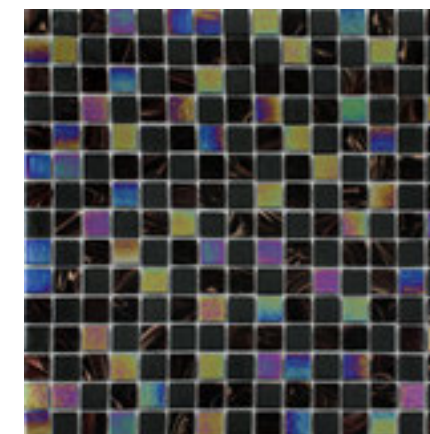

M40/56

32,7x32,7cm

M5/7

Cor: **Indiana**

Ref.: RM01

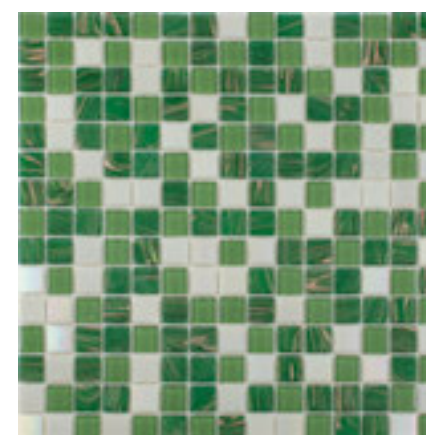

M40/56

32,7x32,7cm

M5/7

Cor: **Prince**

Ref.: RM03

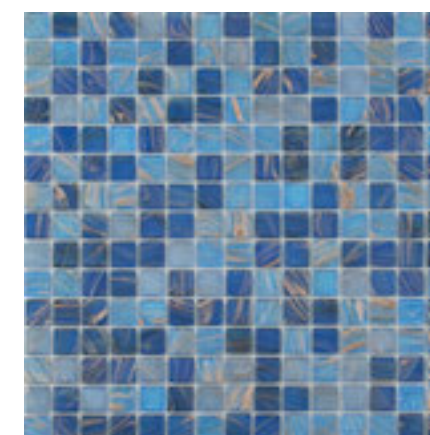

M40/56

32,7x32,7cm

M5/7

Cor: **Giverny**

Ref.: 2020GIVERNY1





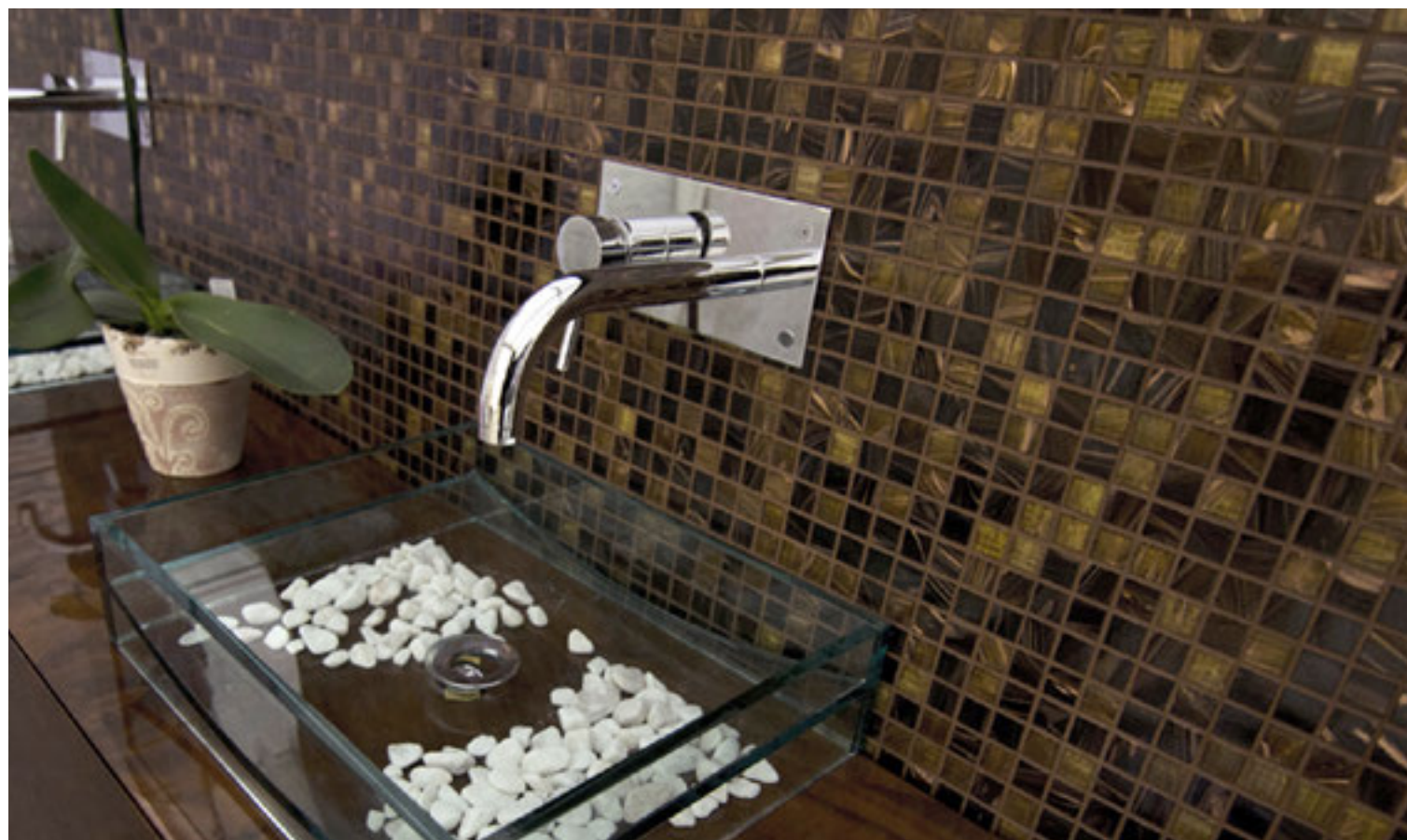

Vidro  
Glass / Verre / Vidrio / Glas



Colado em rede  
Mesh mosaic / Mosaïque collés sur trame  
Mosaik auf netz geklebt / Mosaico en malla



Brilho  
Gloss / Brillant / Glanz / Brillo



Interiores e Exteriores  
Indoors and outdoors / Intérieurs et extérieurs  
Dinnen und draußen / Interior y exterior



Variação Média V1  
Average tone variation / Variation moyenne  
Durchschnittliche Tonhöhenchwankung  
Variación media de tono



Resistente ao gelo  
Frost resistant / Résistant au gel  
Frostbeständig / Resistente a las heladas

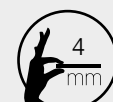

Espessura  
Thickness / Epaisseur / Dicke / Grosor



Requer cola para Vidro  
Glass cement / Ciment pour verre  
Glaskleber / Cemento para vidrio



Adequado a piscinas  
Suitable for pools / Adapté aux piscines  
Geeignet für Pools / Apto para piscinas



PCS  
1 Pc  
0,107 m<sup>2</sup>  
0,77 Kg



CX  
20 Pcs  
2,14 m<sup>2</sup>  
15,30 Kg

# Symphony

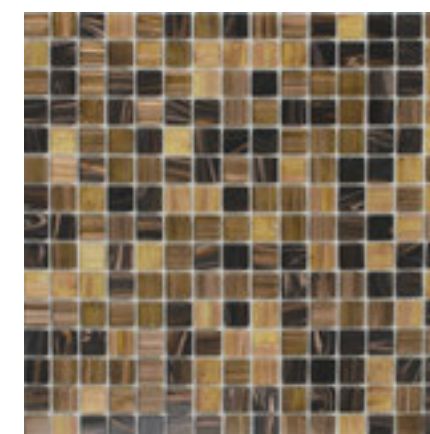

32,7x32,7cm **M40/56** **M5/7**

Cor: **Ritz**  
Ref.: 2020RITZ1 5 606779 106506

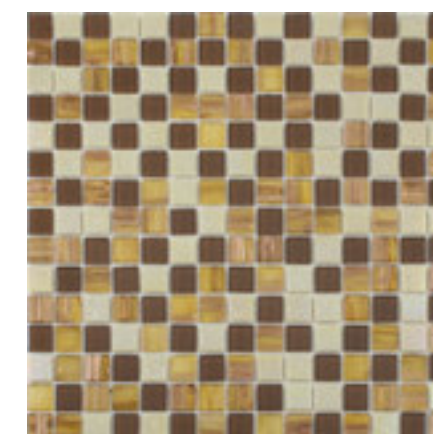

32,7x32,7cm **M40/56** **M5/7**

Cor: **Jersey**  
Ref.: RM04 5 606779 162564

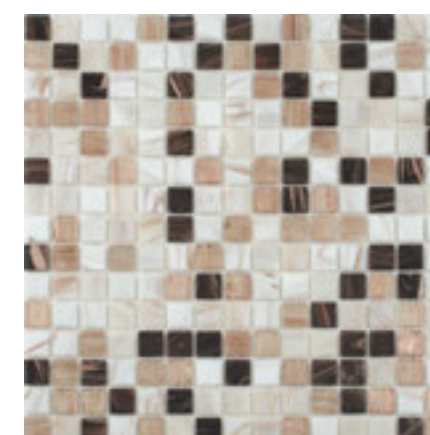

32,7x32,7cm **M40/56** **M5/7**

Cor: **Oxford**  
Ref.: 2020OXFORD1 5 606779 106469



32,7x32,7cm **M40/56** **M5/7**

Cor: **London**  
Ref.: 2020G12 5 606779 106384





Vidro  
Glass / Verre / Vidrio / Glas



Colado em rede  
mesh mosaic / mosaïque collés sur trame  
mosaik auf netz geklebt / mosaico en malla



Mate  
Matt / Mate / Matt / Mate



Interiores  
Indoors only / Intérieurs  
Nur drinnen / Solo en interiores



Variação Média V1  
Average tone variation / Variation moyenne  
Durchschnittliche Tonhöhenchwankung  
Variación media de tono



Resistente ao gelo  
Frost resistant / Résistant au gel  
Frostbeständig / Resistente a las heladas



Espessura  
Thickness / Epaisseur / Dicke / Grosor



Requer cola para vidro  
Glass adhesive / Colle pour verre  
Kleber für Glas / Pegamento para vidrio



Adequado a piscinas



PCS  
1 Pc  
0,09 m<sup>2</sup>  
1 Kg



CX  
12 Pcs  
1,08 m<sup>2</sup>  
12 Kg

# Logic Mate



30x30cm **M75/105** **M8/11.2**   
Cor: **White - Mate**  
Ref.: RMLOGICBR743M 5 606779 191656

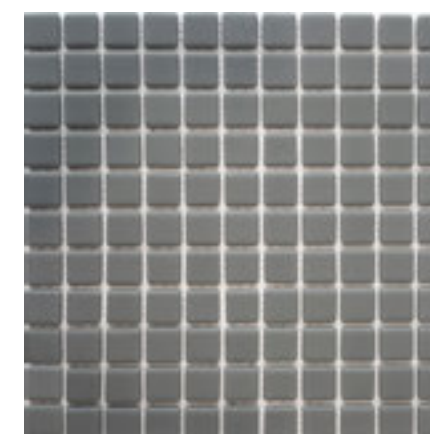

30x30cm **M75/105** **M8/11.2**   
Cor: **Platina - Mate**  
Ref.: RMLOGICPL742M 5 606779 191663

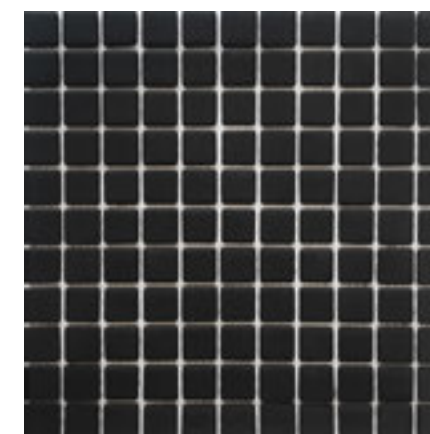

30x30cm **M75/105** **M8/11.2**   
Cor: **Preto - Mate**  
Ref.: RMLOGICPR741M 5 606779 191649





Vidro  
Glass / Verre / Vidrio / Glas



Colado em rede  
Mesh mosaic / Mosaïque collés sur trame  
Mosaik auf netz geklebt / Mosaico en malla



Brilho  
Glass / Brillant / Glanz / Brillo



Interiores e Exteriores  
Indoors and outdoors / Intérieurs et extérieurs  
Dinnen und draußen / Interior y exterior



Varição Média V1  
Average tone variation / Variation moyenne  
Durchschnittliche Tonhöhenchwankung  
Variación media de tono



Resistente ao gelo  
Frost resistant / Résistant au gel  
Frostbeständig / Resistente a las heladas



Espessura  
Thickness / Epaisseur / Dicke / Grosor



Requer cola para Vidro  
Glass cement / Ciment pour verre  
Glaskleber / Cemento para vidrio



Adequado a piscinas  
Suitable for pools / Adapté aux piscines  
Geeignet für Pools / Apto para piscinas



PCS

1 Pc  
0,09 m<sup>2</sup>  
1 Kg



CX

12 Pcs  
1,08 m<sup>2</sup>  
12 Kg

# Iris

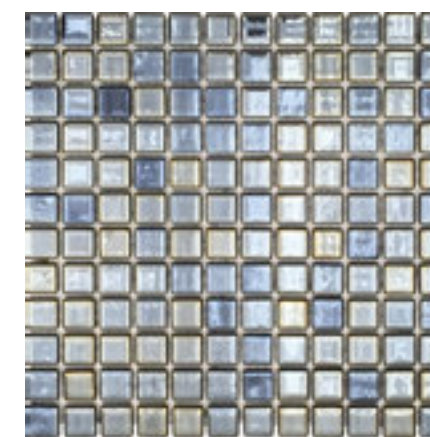

32,7x32,7cm

Cor: **Preta**

Ref.: RMIRISP

M80/112

M8/11.2

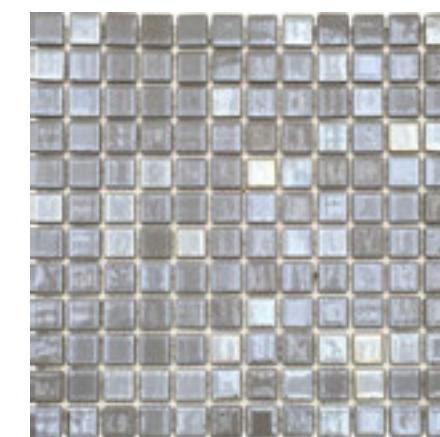

32,7x32,7cm

Cor: **Platina**

Ref.: RMIRISPL

M70/98

M7/9.8

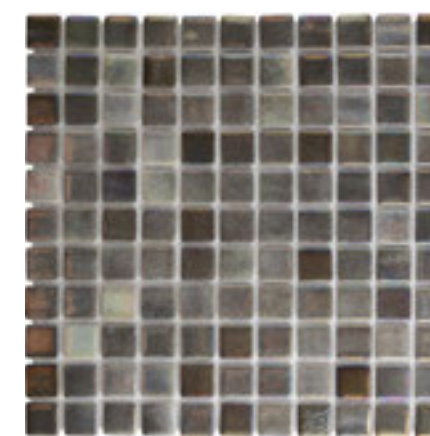

30x30cm

Cor: **Castanho**

Ref.: RMIRIS1011

M110/154

M11/15.4

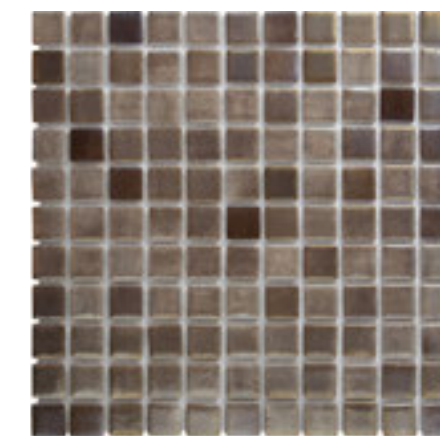

30x30cm

Cor: **Castanho Claro**

Ref.: RMIRIS1002

M110/154

M11/15.4







Vidro  
Glass / Verre / Vidrio / Glas



Colado em rede  
Mesh mosaic / Mosaïque collés sur trame  
Mosaik auf netz geklebt / Mosaico en malla



Brilho  
Glass / Brillant / Glanz / Brillo



Interiores e Exteriores  
Indoors and outdoors / Intérieurs et extérieurs  
Dinnen und draußen / Interior y exterior



Variação Média V1  
Average tone variation / Variation moyenne  
Durchschnittliche Tonhöhenchwankung  
Variación media de tono



Resistente ao gelo  
Frost resistant / Résistant au gel  
Frostbeständig / Resistente a las heladas



Espessura  
Thickness / Epaisseur / Dicke / Grosor



Requer cola para Vidro  
Glass cement / Ciment pour verre  
Glaskleber / Cemento para vidrio



Adequado a piscinas  
Suitable for pools / Adapté aux piscines  
Geeignet für Pools / Apto para piscinas



PCS  
1 Pc  
0,09 m<sup>2</sup>  
1 Kg



CX  
12 Pcs  
1,08 m<sup>2</sup>  
12 Kg

# Iris

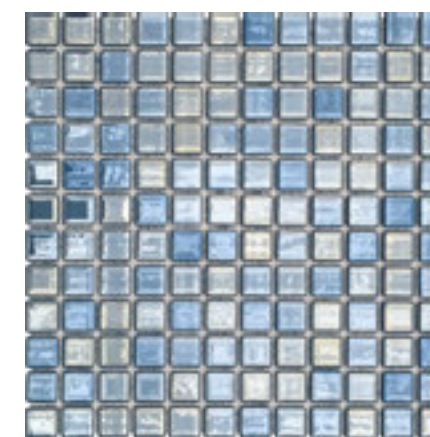

30x30cm

Cor: **Azul**  
Ref.: RMIRISAZC

M110/154

M11/15.4

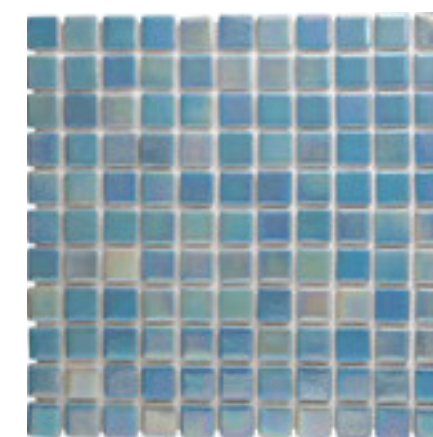

30x30cm

Cor: **Azul Claro**  
Ref.: RMIRIS1010

M70/98

M7/9.8

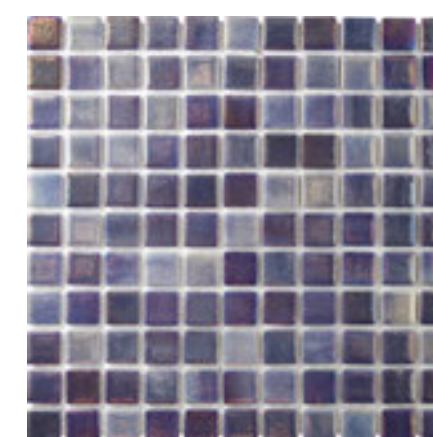

30x30cm

Cor: **Lilás/Roxo**  
Ref.: RMIRIS1005

M70/98

M7/9.8







Vidro  
Glass / Verre / Vidrio / Glas



Colado em rede  
mesh mosaic / mosaïque collés sur trame  
mosaik auf netz geklebt / mosaico en malla



Brilho  
Gloss / Gloss / Glanz / Brillo



Interiores  
Indoors only / Intérieurs  
Nur drinnen / Solo en interiores



Variação Média V1  
Average tone variation / Variation moyenne  
Durchschnittliche Tonhöhenchwankung  
Variación media de tono



Resistente ao gelo  
Frost resistant / Résistant au gel  
Frostbeständig / Resistente a las heladas



Espessura  
Thickness / Epaisseur / Dicke / Grosor



Requer cola para vidro  
Glass adhesive / Colle pour verre  
Kleber für Glas / Pegamento para vidrio



Adequado a piscinas  
Suitable for pools / Adapté aux piscines  
Geeignet für Pools / Apto para piscinas



PCS

1 Pc  
0,09 m<sup>2</sup>  
1 Kg



CX

12 Pcs  
1,08 m<sup>2</sup>  
12 Kg

# Logic



M42/59

30x30cm

M4.3/6

Cor: Laguna - Gloss

Ref.: RMLOGICLG



5 606779 186782



M42/59

30x30cm

M4.3/6

Cor: White - Gloss

Ref.: RMLOGICWP5



5 606779 186775

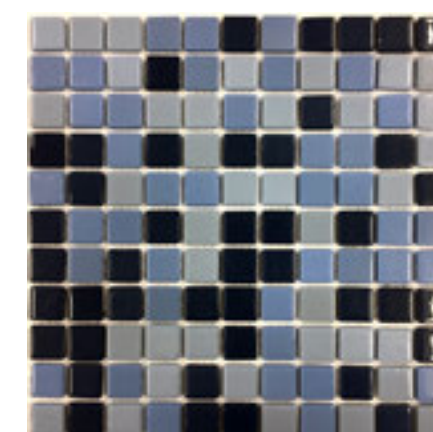

M42/59

30x30cm

M4.3/6

Cor: Bahamas - Gloss

Ref.: RMLOGICBH



5 606779 186799



M42/59

30x30cm

M4.3/6

Cor: B&W - Gloss

Ref.: RMLOGICP&W



5 606779 186768





Vidro  
Glass / Verre / Vidrio / Glas



Colado em rede  
mesh mosaic / mosaïque collés sur trame  
mosaik auf netz geklebt / mosaico en malla



Brilho  
Gloss / Gloss / Glanz / Brillo



Interiores  
Indoors only / Intérieurs  
Nur drinnen / Solo en interiores



Variação Média V1  
Average tone variation / Variation moyenne  
Durchschnittliche Tonhöhenchwankung  
Variación media de tono



Resistente ao gelo  
Frost resistant / Résistant au gel  
Frostbeständig / Resistente a las heladas



Espessura  
Thickness / Epaisseur / Dicke / Grosor



Requer cola para vidro  
Glass adhesive / Colle pour verre  
Kleber für Glas / Pegamento para vidrio



PCS  
1 Pc  
0,096 m<sup>2</sup>  
1,16 Kg



CX  
12 Pcs  
1,15 m<sup>2</sup>  
14 Kg

# Lejo Tokio

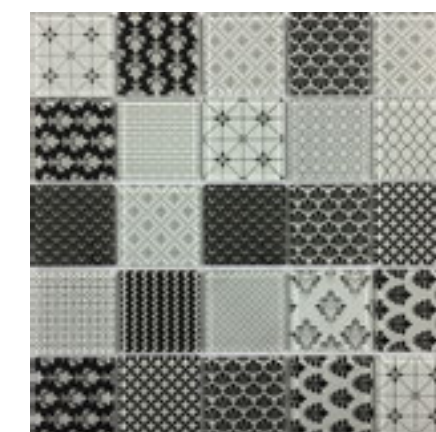

M135/189

31x31cm

M13.5/19

Cor: **Tokio**

Ref.: RMLEJOTOK



# Lejo Belém



M135/189

31x31cm

M13.5/19

Cor: **Belém**

Ref.: RMLEJOBL



PASTILHAS E MOSAICOS





Vidro  
Glass / Verre / Vidrio / Glas



Colado em rede  
mesh mosaic / mosaïque collés sur trame  
mosaik auf netz geklebt / mosaico en malla



Brilho  
Gloss / Gloss / Glanz / Brillo



Interiores  
Indoors only / Intérieurs  
Nur drinnen / Solo en interiores



Variação Média V1  
Average tone variation / Variation moyenne  
Durchschnittliche Tonhöhenchwankung  
Variación media de tono



Resistente ao gelo  
Frost resistant / Résistant au gel  
Frostbeständig / Resistente a las heladas

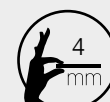

Espessura  
Thickness / Epaisseur / Dicke / Grosor



Requer cola para vidro  
Glass adhesive / Colle pour verre  
Kleber für Glas / Pegamento para vidrio

<b>CUBIC</b>	<b>CRACK</b>	<b>SWEET</b>
1 Pc	1 Pc	1 Pc
0,063 m <sup>2</sup>	0,09 m <sup>2</sup>	0,09 m <sup>2</sup>
0,59 Kg	1 Kg	1,33 Kg

<b>CX</b>	<b>CX</b>	<b>CX</b>
12 Pcs	12 Pcs	12 Pcs
0,756 m <sup>2</sup>	1,08 m <sup>2</sup>	1,08 m <sup>2</sup>
7,05 Kg	14,21 Kg	16 Kg

3D

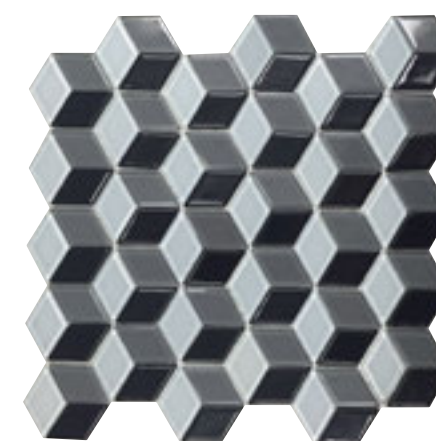

**M140/196**

27x28cm / 4mm **M14/20**

Cor: **Cubic**

Ref.: RMLEJOCUBIC

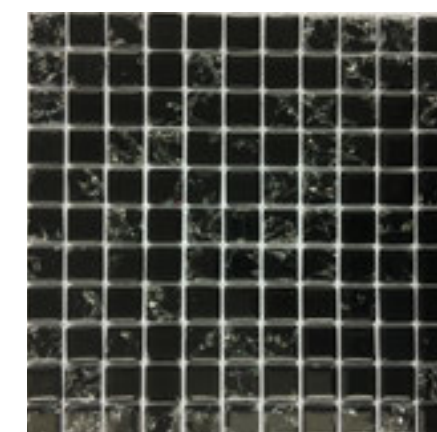

**M125/175**

30x30cm / 5mm **M13/18**

Cor: **Black Crack**

Ref.: RMLEJOBK

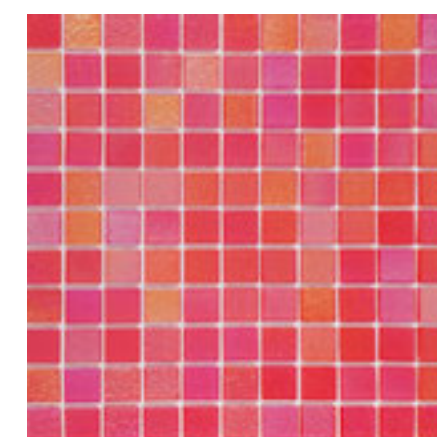

**M120/168**

30x30cm / 6mm **M12/17**

Cor: **Sweet Love**

Ref.: RMH25066RED





Vidro  
Glass / Verre / Vidrio / Glas



Colado em rede  
mesh mosaic / mosaïque collés sur trame  
mosaik auf netz geklebt / mosaico en malla



Brilho  
Gloss / Gloss / Glanz / Brillo



Interiores  
Indoors only / Intérieurs  
Nur drinnen / Solo en interiores



Variação Média V1  
Average tone variation / Variation moyenne  
Durchschnittliche Tonhöhenchwankung  
Variación media de tono



Resistente ao gelo  
Frost resistant / Résistant au gel  
Frostbeständig / Resistente a las heladas

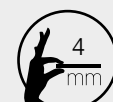

Espessura  
Thickness / Epaisseur / Dicke / Grosor



Requer cola para vidro  
Glass adhesive / Colle pour verre  
Kleber für Glas / Pegamento para vidrio



PCS  
1 Pc  
0,09 m<sup>2</sup>  
0,815 Kg



CX  
20 Pcs  
1,74 m<sup>2</sup>  
15,20 Kg

# Architect Glass



**M85/119**

**30x30cm** **M8.5/12**

Cor: **A10 White**

Ref.: 2525A104

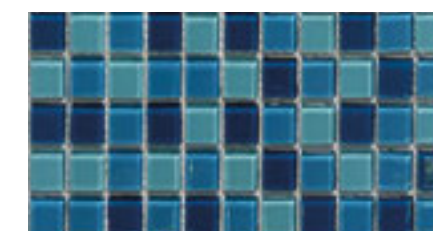

**M85/119**

**30x30cm** **M8.5/12**

Cor: **Ocean**

Ref.: RMGR25B01



**M85/119**

**30x30cm** **M8.5/12**

Cor: **C65 Cyan**

Ref.: 2525C654



**M85/119**

**30x30cm** **M8.5/12**

Cor: **D20 Grey**

Ref.: 2525D204

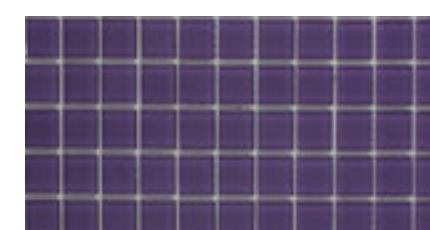

**M85/119**

**30x30cm** **M8.5/12**

Cor: **P03 Roxo**

Ref.: 2525P034

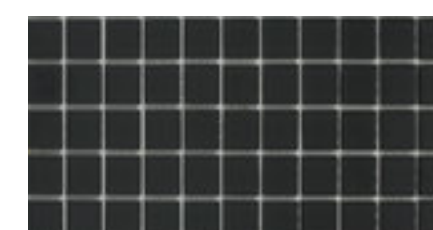

**M85/119**

**30x30cm** **M8.5/12**

Cor: **K42 Black**

Ref.: 2525K124





Vidro  
Glass / Verre / Vidrio / Glas



Colado em rede  
mesh mosaic / mosaïque collés sur trame  
mosaik auf netz geklebt / mosaico en malla



Brilho  
Gloss / Gloss / Glanz / Brillo



Interiores  
Indoors only / Intérieurs  
Nur drinnen / Solo en interiores



Variação Média V1  
Average tone variation / Variation moyenne  
Durchschnittliche Tonhöhenchwankung  
Variación media de tono



Resistente ao gelo  
Frost resistant / Résistant au gel  
Frostbeständig / Resistente a las heladas



Espessura  
Thickness / Epaisseur / Dicke / Grosor



Requer cola para vidro  
Glass adhesive / Colle pour verre  
Kleber für Glas / Pegamento para vidrio



PCS

1 Pc  
0,09 m<sup>2</sup>  
1,33 Kg



CX

14 Pcs  
1,26 m<sup>2</sup>  
18,50 Kg

# Architect Glass

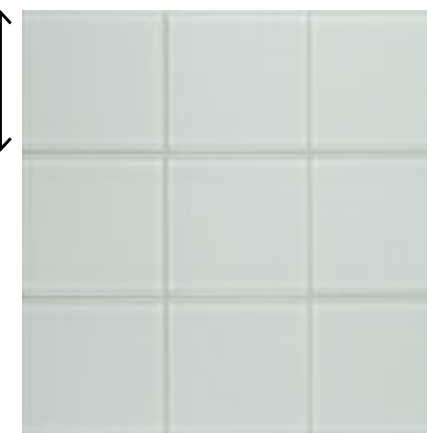
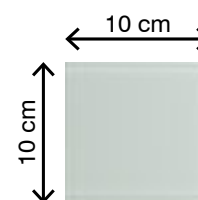

30x30cm **M90/126** **M9/13**

Cor: **A10 White - Gloss**

Ref.: 9898A10



30x30cm **M90/126** **M9/13**

Cor: **C65 Cyan - Gloss**

Ref.: 9898C65



30x30cm **M90/126** **M9/13**

Cor: **D20 Grey - Gloss**

Ref.: 9898D20



30x30cm **M90/126** **M9/13**

Cor: **K42 Black - Gloss**

Ref.: 9898G03



30x30cm **M90/126** **M9/13**

Cor: **J001 Orange Gloss**

Ref.: 9898J001



30x30cm **M90/126** **M9/13**

Cor: **R50 Red - Gloss**

Ref.: 9898R50



30x30cm **M90/126** **M9/13**

Cor: **C03 Green - Gloss**

Ref.: 9898C03





Vidro  
Glass / Verre / Vidrio / Glas



Colado em rede  
mesh mosaic / mosaïque collés sur trame  
mosaik auf netz geklebt / mosaico en malla



Mate  
Matt / Mat / Mattes / Mate



Interiores  
Indoors only / Intérieurs  
Nur drinnen / Solo en interiores



Variação Média V1  
Average tone variation / Variation moyenne  
Durchschnittliche Tonhöhenchwankung  
Variación media de tono



Resistente ao gelo  
Frost resistant / Résistant au gel  
Frostbeständig / Resistente a las heladas



Espessura  
Thickness / Epaisseur / Dicke / Grosor



Requer cola para vidro  
Glass adhesive / Colle pour verre  
Kleber für Glas / Pegamento para vidrio



1 Pc  
0,09 m<sup>2</sup>  
1,33 Kg



14 Pcs  
1,26 m<sup>2</sup>  
18,5 Kg

# Architect Glass

10 cm



30x30cm **M90/126**  
Cor: **C65 Cyan - Mate**  
Ref.: 9898C65M



30x30cm **M90/126**  
Cor: **D20 Grey - Mate**  
Ref.: 9898D20M

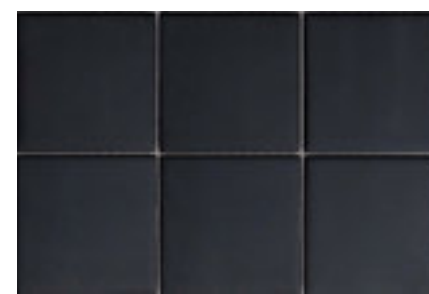

30x30cm **M90/126**  
Cor: **K42 Black - Mate**  
Ref.: 9898G03M



30x30cm **M90/126**  
Cor: **C03 Green - Mate**  
Ref.: 9898C03M



30x30cm **M90/126**  
Cor: **J001 Orange - Mate**  
Ref.: 9898J001M



30x30cm **M90/126**  
Cor: **R50 Red - Mate**  
Ref.: 9898R50M



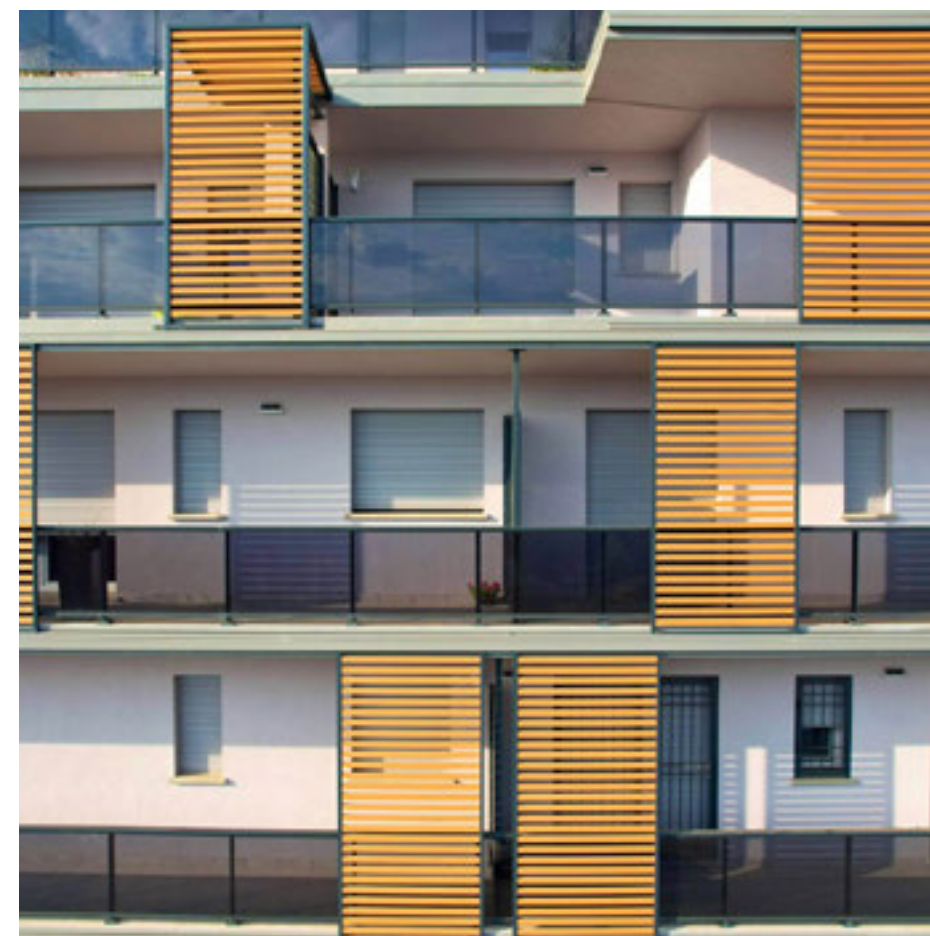

## REVESTIMIENTO DE FACHADA CO-EXTRUDIDO

Co-Extrusion Cladding / Bardage composite coextrudée  
Co-Extrusionsverkleidung Cla / Revestimiento de coextrusión





### Revestimento de fachada em composto Ideal para a renovação de fachadas

**Formato:** em régua  
**Efeito:** madeira ripada (junta aberta)  
**Material:** WPC composto co-extrudido com cobertura externa de 360° protegendo a régua completamente contra manchas, desbotamento da cor, mofo, podridão ou rachaduras  
**Acabamento:** com relevos  
**Instalação:** Fachadas, Tectos, fachadas ventiladas, paredes e tectos interiores  
**Manutenção:** nenhuma  
**Limpeza:** apenas Água

**Características:** isolante, resistente a raios UV, resistente, reciclável, durável, cor natural



Compósito Co-Extrudido  
 Co-Extruded composite / Composite co-extrudé  
 Com-extrudierter Verbundwerkstoff  
 Compósito Co-extrudado



Mate  
 Matte / Mate / Mattes / Mate



Interiores & Exteriores  
 Indoors and Outdoors / Intérieurs  
 Nur drinnen / Solo en interiores



Variação Média V1  
 Average tone variation / Variation moyenne  
 Durchschnittliche Tonhöhenchwankung  
 Variación media de tono



Resistente ao gelo  
 Frost resistant / Résistant au gel  
 Frostbeständig / Resistente a las heladas



Espessura  
 Thickness / Epaisseur / Dicke / Grosor

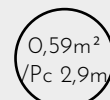

Área coberta em m<sup>2</sup>/peça  
 Square meter per piece / Mètre carré par pièce  
 Quadratmeter pro Stück / metro cuadrado por pieza



Requer pré instalação de vigas em alumínio  
 Requires pre-installation of aluminum joist  
 Nécessite pré-installation de lambourdes en aluminium  
 Erfordert die Vorinstallation von Aluminiumbalken  
 Requiere preinstalación de rastrel de aluminio



Furos para parafusos  
 Holes for screws / Trous pour visse  
 Bohrungen / Orificios para tornillos



Classificação ao Fogo 13501-1:2007+A1:2009  
 Fire Classification / Classement feu  
 Feuerklassifizierung / Clasificación de fuego



3Pcs - 2,9m  
 1,74 m<sup>2</sup>  
 25 Kg

## Ripado Co-extrudido Gold



4m

F95/133

Série: **Fachada - Ripado**

Ref.: RF21926GOLTEK4M



2,90m

F95/133

Série: **Fachada - Ripado**

Ref.: RF21926GOLTEK



2,90m

F22/31 unit

Série: **Fachada - Ripado**

Ref.: RF21926GOLPF



2,90m

F22/31 unit

Série: **Fachada - Ripado**

Ref.: RF21926GOLPFESQ



2,20m (25x50mm)

F22/31 unit

Série: **Perfil Alumínio**

Ref.: VIGAALUM



Aço Inox

F1/1.4 unit

Série: **Clip**

Ref.: CLIPRIP

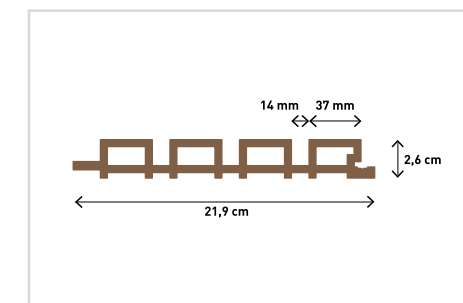

VEJA O MANUAL DE INSTALAÇÃO  
 CHECK THE INSTRUCTIONS MANUAL  
 REGARDEZ LA MANUEL D'INSTALLATION  
 VEA EL MANUAL DE INSTRUCCIONES



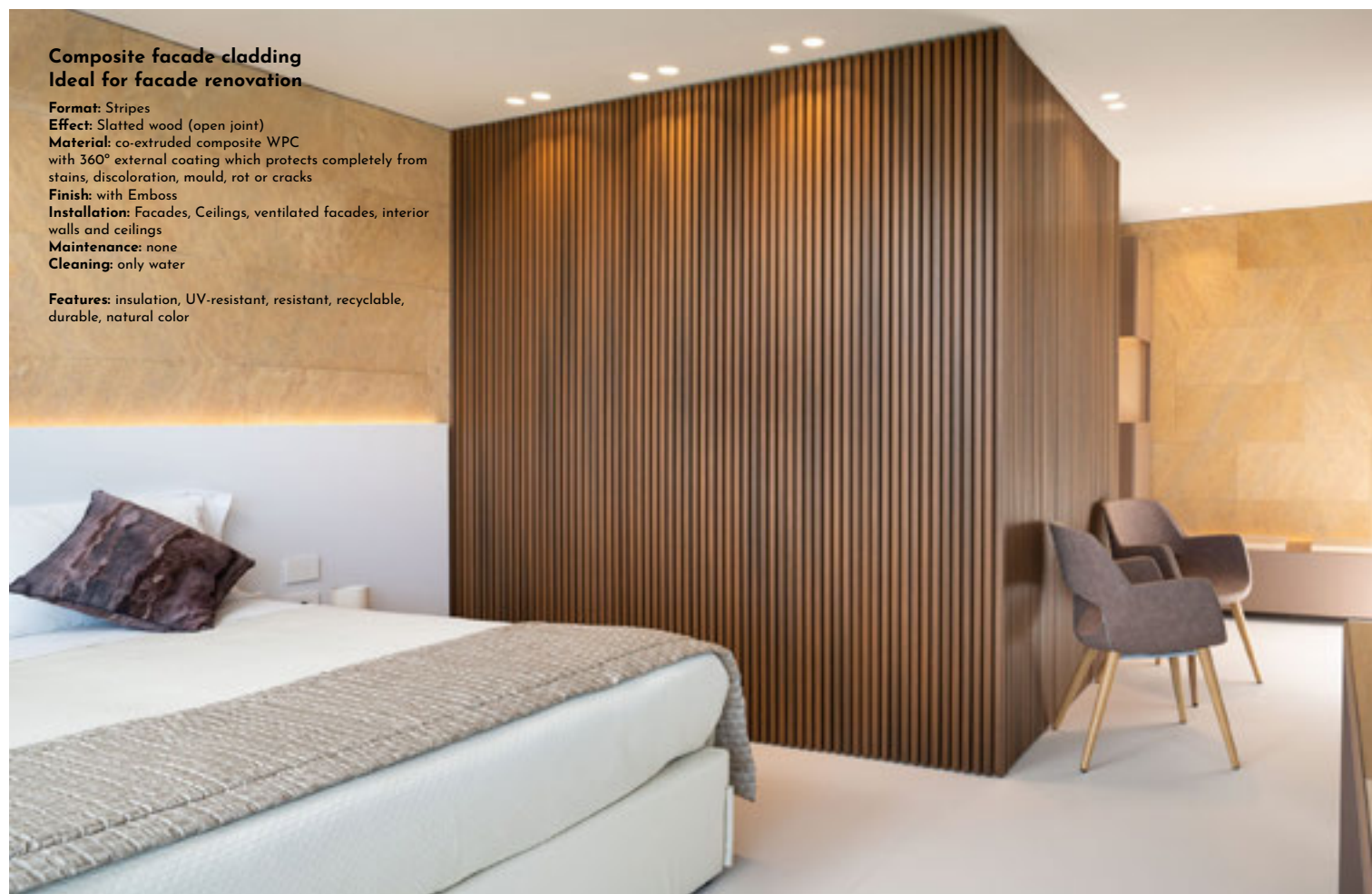
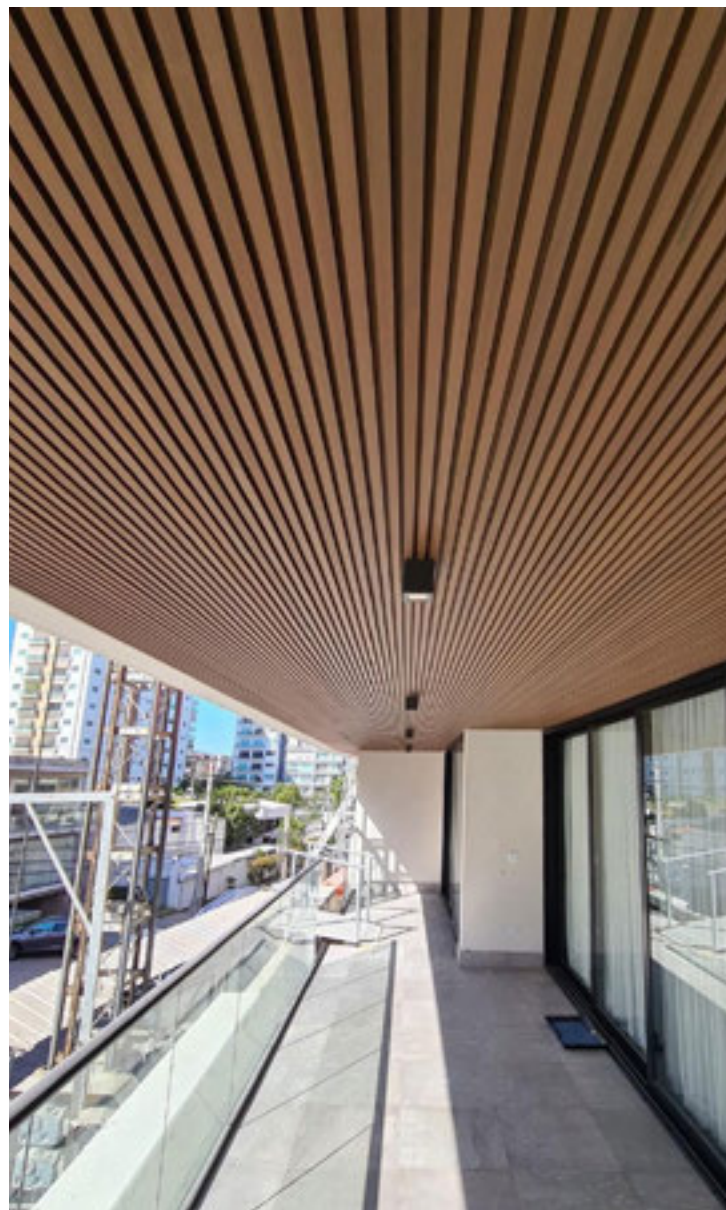

**Composite facade cladding**  
Ideal for facade renovation

**Format:** Stripes  
**Effect:** Slatted wood (open joint)  
**Material:** co-extruded composite WPC with 360° external coating which protects completely from stains, discoloration, mould, rot or cracks  
**Finish:** with Emboss  
**Installation:** Facades, Ceilings, ventilated facades, interior walls and ceilings  
**Maintenance:** none  
**Cleaning:** only water

**Features:** insulation, UV-resistant, resistant, recyclable, durable, natural color



Compósito Co-Extrudido  
 Co-Extruded composite / Composite co-extrudé  
 Com-extrudierter Verbundwerkstoff  
 Compósito Co-extrudado



Mate  
 Matte / Mate / Mattes / Mate



Interiores & Exteriores  
 Indoors and Outdoors / Intérieurs  
 Nur drinnen / Solo en interiores



Variação Média V1  
 Average tone variation / Variation moyenne  
 Durchschnittliche Tonhöhenchwankung  
 Variación media de tono



Resistente ao gelo  
 Frost resistant / Résistant au gel  
 Frostbeständig / Resistente a las heladas

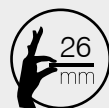

Espessura  
 Thickness / Épaisseur / Dicke / Grosor

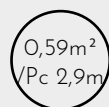

0,59m<sup>2</sup>  
 /Pc 2,9m  
 Área coberta em m<sup>2</sup>/peça  
 Square meter per piece / Mètre carré par pièce  
 Quadratmeter pro Stück / metro cuadrado por pieza  
 Requiere preinstalación de rastrel de aluminio



Requer pré instalação de vigas em alumínio  
 Requires pre-installation of aluminum joist  
 Nécessite pré-installation de lambourdes en aluminium  
 Erfordert die Vorinstallation von Aluminiumbalken  
 Requiere preinstalación de rastrel de aluminio



Furos para parafusos  
 Holes for screws / Troux pour visse  
 Bohrungen / Orificios para tornillos



Classificação ao Fogo 13501-1:2007+A1:2009  
 Fire Classification / Classement feu  
 Feuerklassifizierung / Clasificación de fuego

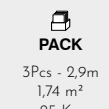

PACK  
 3Pcs - 2,9m  
 1,74 m<sup>2</sup>  
 25 Kg

# Ripado Co-extrudido Teak



4m

F95/133

Série: Fachada - Ripado

Ref.: RF21926TEK4M



2,90m

F95/133

Série: Fachada - Ripado

Ref.: RF21926TEK



2,90m

F22/31 unit

Série: Fachada - Ripado

Ref.: RF21926TEKPF



2,90m

F22/31 unit

Série: Fachada - Ripado

Ref.: RF21926TEKPFESQ



2,20m (25x50mm)

F22/31 unit

Série: Perfil Alumínio

Ref.: VIGAALUM



Aço Inox

F1/1.4 unit

Série: Clip

Ref.: CLIPRIP

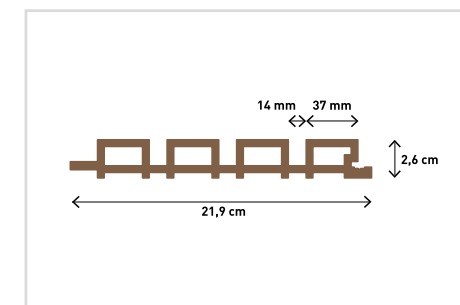

VEJA O MANUAL DE INSTALAÇÃO  
 CHECK THE INSTRUCTIONS MANUAL  
 REGARDEZ LA MANUEL D'INSTALLATION  
 VEA EL MANUAL DE INSTRUCCIONES





**Composite facade cladding**  
**Ideal for facade renovation**

**Format:** Stripes  
**Effect:** Slatted wood (open joint)  
**Material:** co-extruded composite WPC with 360° external coating which protects completely from stains, discoloration, mould, rot or cracks  
**Finish:** with Emboss  
**Installation:** Facades, Ceilings, ventilated facades, interior walls and ceilings  
**Maintenance:** none  
**Cleaning:** only water

**Features:** insulation, UV-resistant, resistant, recyclable, durable, natural color

- 

Compósito Co-Extrudido  
 Co-Extruded composite / Composite co-extrudé  
 Com-extrudierter Verbundwerkstoff  
 Compósito Co-extrudado
- 

Mate  
 Matte / Mate / Mattes / Mate
- 

Interiores & Exteriores  
 Indoors and Outdoors / Intérieurs  
 Nur drinnen / Solo en interiores
- 

Variação Média V1  
 Average tone variation / Variation moyenne  
 Durchschnittliche Tonhöhenchwankung  
 Variación media de tono
- 

Resistente ao gelo  
 Frost resistant / Résistant au gel  
 Frostbeständig / Resistente a las heladas
- 

26 mm  
 Espessura  
 Thickness / Épaisseur / Dicke / Grosor
- 

0,59m<sup>2</sup>  
 /Pc 2,9m  
 Área coberta em m<sup>2</sup>/peça  
 Square meter per piece / Mètre carré par pièce  
 Quadratmeter pro Stück / metro cuadrado por pieza
- 

40 cm  
 Requer pré instalação de vigas em alumínio  
 Requires pre-installation of aluminum joist  
 Nécessite pré-installation de lambourdes en aluminium  
 Erfordert die Vorinstallation von Aluminiumbalken  
 Requiere preinstalación de rastrel de aluminio
- 

15 mm  
 Furos para parafusos  
 Holes for screws / Troux pour visse  
 Bohrungen / Orificios para tornillos
- 

B-s2, d0  
 Classificação ao Fogo 13501-1:2007+A1:2009  
 Fire Classification / Classement feu  
 Feuerklassifizierung / Clasificación de fuego
- 

PACK  
 3Pcs - 2,9m  
 1,74 m<sup>2</sup>  
 25 Kg

# Ripado Co-extrudido Antique



2,90m **F95/133**  
 Série: **Fachada - Ripado**  
 Ref.: RF21926ANTTEK 



2,90m **F22/31 unit**  
 Série: **Fachada - Ripado**  
 Ref.: RF21926ANTPF 



2,90m **F22/31 unit**  
 Série: **Fachada - Ripado**  
 Ref.: RF21926ANTPFESQ 



2,20m (25x50mm) **F22/31 unit**  
 Série: **Perfil Alumínio**  
 Ref.: VIGAALUM 



Aço Inox **F1/1.4 unit**  
 Série: **Clip**  
 Ref.: CLIPRIP 

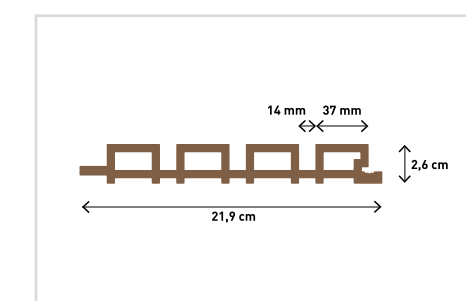

 VEJA O MANUAL DE INSTALAÇÃO  
 CHECK THE INSTRUCTIONS MANUAL  
 REGARDEZ LA MANUEL D'INSTALLATION  
 VEA EL MANUAL DE INSTRUCCIONES





WPC

Compósito  
Composite / Composite  
Verbundwerkstoff / Composito



Mate  
Matte / Mate / Mattes / Mate



Interiores & Exteriores  
Indoors and Outdoors / Intérieurs  
Nur drinnen / Solo en interiores



Variação Média V1  
Average tone variation / Variation moyenne  
Durchschnittliche Tonhöhenchwankung  
Variación media de tono



Resistente ao gelo  
Frost resistant / Résistant au gel  
Frostbeständig / Resistente a las heladas



Espessura  
Thickness / Epaisseur / Dicke / Grosor

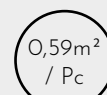

Área coberta em m<sup>2</sup>/peça  
Square meter per piece / Mètre carré par pièce  
Quadratmeter pro Stück / metro cuadrado por pieza



Requer pré instalação de vigas em alumínio  
Requires pre-installation of aluminum joist  
Nécessite pré-installation de lambourdes en aluminium  
Erfordert die Vorinstallation von Aluminiumbalken  
Requiere preinstalación de rastrel de aluminio



Furos para parafusos  
Holes for screws / Troux pour visse  
Bohrungen / Orificios para tornillos



Classificação ao Fogo 13501-1:2007+A1:2009  
Fire Classification / Classement feu  
Feuerklassifizierung / Clasificación de fuego



PACK  
4 Pcs  
2,36 m<sup>2</sup>  
25 Kg

## Ripado WPC



(55x45mm)

2,90m TECA

F15/21

Série: **PERFIL L DE ACABAMENTO**

Ref.: RF21926TKPF



5 606779 252104

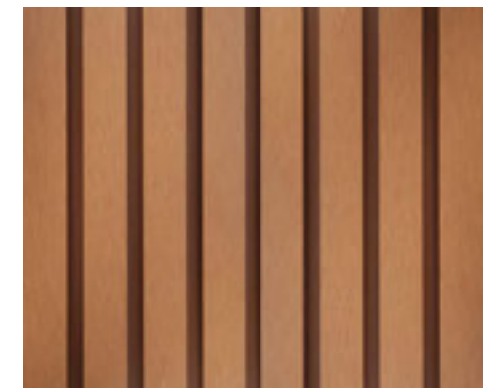

2,90m TECA

F60/84

Série: **Fachada - Ripado**

Ref.: RF21926TK



5 606779 252074



(55x45mm)

2,90m CHOCOLATE

F15/21

Série: **PERFIL L DE ACABAMENTO**

Ref.: RF21926CHOCPF



5 606779 252098



2,90m CHOCOLATE

F60/84

Série: **Fachada - Ripado**

Ref.: RF21926CHOC



5 606779 252036



(55x45mm)

2,90m TIJOLO

F15/21

Série: **PERFIL L DE ACABAMENTO**

Ref.: RF21926TIJPF



5 606779 252111

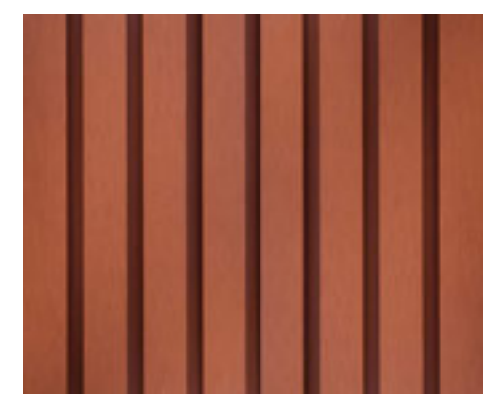

2,90m TIJOLO

F60/84

Série: **Fachada - Ripado**

Ref.: RF21926TIJ



5 606779 252050

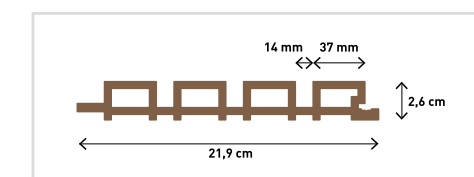

VEJA O MANUAL DE INSTALAÇÃO  
CHECK THE INSTRUCTIONS MANUAL  
REGARDEZ LA MANUEL D'INSTALLATION  
VEA EL MANUAL DE INSTRUCCIONES





WPC

Compósito  
Composite / Composite  
Verbundwerkstoff / Composito



Mate  
Matte / Mate / Mattes / Mate



Interiores & Exteriores  
Indoors and Outdoors / Intérieurs  
Nur drinnen / Solo en interiores



Variação Média V1  
Average tone variation / Variation moyenne  
Durchschnittliche Tonhöhenchwankung  
Variación media de tono



Resistente ao gelo  
Frost resistant / Résistant au gel  
Frostbeständig / Resistente a las heladas



26 mm  
Espessura  
Thickness / Epaisseur / Dicke / Grosor

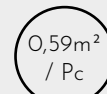

0,59m<sup>2</sup>  
/ Pc  
Área coberta em m<sup>2</sup>/ peça  
Square meter per piece / Mètre carré par pièce  
Quadratmeter pro Stück / metro cuadrado por pieza



40 cm  
Requer pré instalação de vigas em alumínio  
Requires pre-installation of aluminum joist  
Nécessite pré-installation de lambourdes en aluminium  
Erfordert die Vorinstallation von Aluminiumbalken  
Requiere preinstalación de rastrel de aluminio



15 mm  
Furos para parafusos  
Holes for screws / Troux pour visse  
Bohrungen / Orificios para tornillos



B-s2, d0  
Classificação ao Fogo 13501-1:2007+A1:2009  
Fire Classification / Classement feu  
Feuerklassifizierung / Clasificación de fuego



PACK  
4 Pcs  
2,36 m<sup>2</sup>  
25 Kg

## Ripado WPC



(55x45mm)

2,90m WHITE

F15/21

Série: **PERFIL L DE ACABAMENTO**

Ref.: RF21926WHIPF



5 606779 252128



2,90m WHITE

F60/84

Série: **Fachada - Ripado**

Ref.: RF21926WHI



5 606779 252043

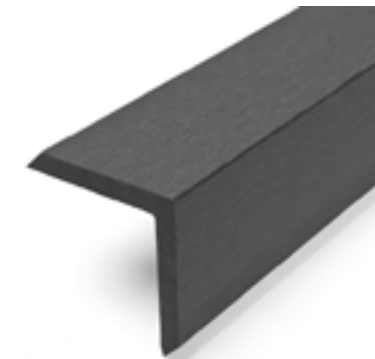

(55x45mm)

2,90m BLACK

F15/21

Série: **PERFIL L DE ACABAMENTO**

Ref.: RF21926BLKPF



5 606779 252104



2,90m BLACK

F60/84

Série: **Fachada - Ripado**

Ref.: RF21926BLK



5 606779 252074



2,20m (25x50mm)

F22/31 unit

Série: **Perfil Alumínio**

Ref.: VIGAALUM



5 606779 180605



Aço Inox

F1/1.4 unit

Série: **Clip**

Ref.: CLIPRIP



5 606779 253972

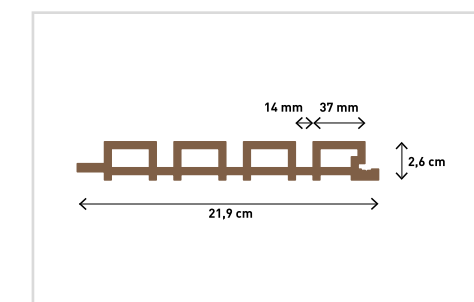

VEJA O MANUAL DE INSTALAÇÃO  
CHECK THE INSTRUCTIONS MANUAL  
REGARDEZ LA MANUEL D'INSTALLATION  
VEA EL MANUAL DE INSTRUCCIONES





# Landscape

Vigas em alumínio revestidas a BPC  
 BPC-coated aluminum beams  
 Poutres en aluminium avec revêtement BPC  
 Vigas de aluminio con revestimiento de BPC

Mantém o aspecto da madeira  
 Maintains the appearance of the wood  
 Garde l'aspect du bois  
 Mantiene el aspecto de la madera

Produto reforçado com alumínio,  
 Aluminum reinforced product  
 Produit renforcé avec de l'Aluminium  
 Producto reforzado con aluminio

Os perfis alveolares Rubicer são o material perfeito para pérgolas, gazebos e elementos de vedação ou fachada. As nossas vigas leves substituem estruturas pesadas de aço ou madeira que exigem pintura e manutenção periódica para evitar a deterioração por exposição ao clima ou corrosão. Os perfis Rubicer mantêm a estética premium da madeira em terraços e jardins, vedações, fachadas de edifícios e outras aplicações.

Rubicer honeycomb profiles are the perfect material for pergolas, gazebos and sealing or facade elements. Our lightweight beams replace heavy steel or wood structures that require periodic maintenance and painting to prevent deterioration due to weather exposure or corrosion. Rubicer profiles maintain the premium aesthetics of wood in terraces and gardens, fences, building facades and other applications.

Les profils alvéolaires Rubicer sont parfaits pour les pérgolas, les abris de jardin et les éléments d'étanchéité ou de façade. Nos poutres légères remplacent les structures lourdes en acier ou en bois qui nécessitent un entretien régulier pour éviter la détérioration causée par le climat ou la corrosion. Les profils Rubicer apportent l'esthétique premium du bois pour habiller terrasses et jardins, clôtures, façades de bâtiments et bien d'autres aménagements.

Los perfiles alveolares Rubicer son el material perfecto para pérgolas, cenadores y elementos de sellado o fachada. Nuestras vigas livianas reemplazan las estructuras pesadas de acero o madera que requieren mantenimiento y pintura periódicos para evitar el deterioro debido a la exposición a la intemperie o la corrosión. Los perfiles Rubicer mantienen la estética premium de la madera en terrazas y jardines, cercas, fachadas de edificios y otras aplicaciones.



Baixo peso - centro Alveolar  
 Low weight - Alveolar center  
 Très Léger - intérieur alvéolaire  
 Peso reducido: centro alveolar



Sem tratamento na superfície  
 No surface treatment  
 Pas de traitement en surface  
 Sin tratamiento superficial



Resistente a raios UV e a intempéries  
 UV and weather resistant  
 Résistant aux UV et aux intempéries  
 Resistente a los rayos UV y a la intemperie



Baixa manutenção  
 Low maintenance  
 Pratiquement aucun entretien  
 Bajo mantenimiento



Múltiplas Aplicações  
 Multiple Applications  
 Usages Multiples  
 Múltiples aplicaciones



Sem corrosão, apodrecimento ou térmitas  
 Corrosion-free Rotting or Termites  
 Sans corrosion, pourrissement ou termites  
 Libre de corrosión podredumbre o termitas

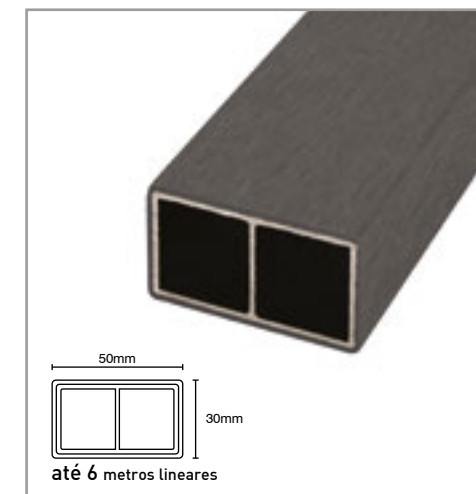
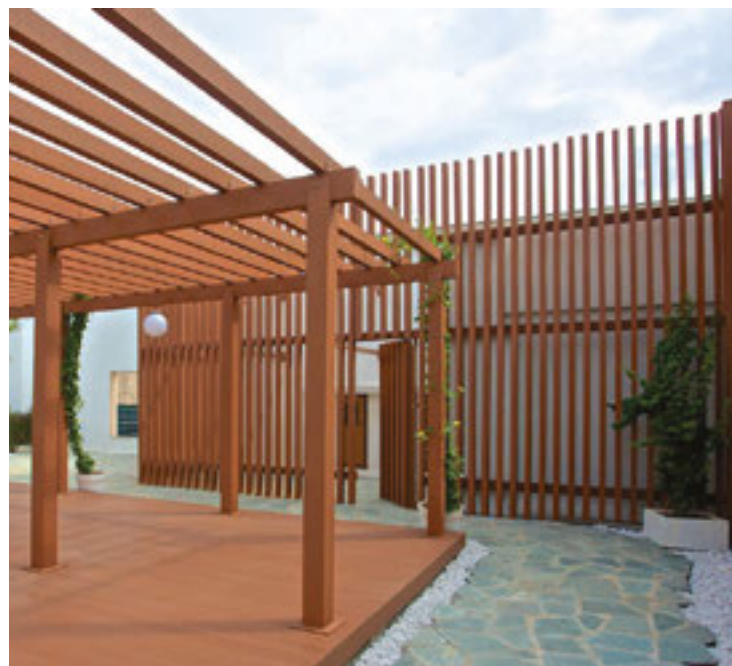

Viga Alveolar ALU/BPC **D18/25.2 ml**  
 Série: **Fachada Vigas**  
 Ref.: RDSTLS09SIL 



Viga Alveolar ALU/BPC **D18/25.2 ml**  
 Série: **Fachada Vigas**  
 Ref.: RDSTLS09CHOC 

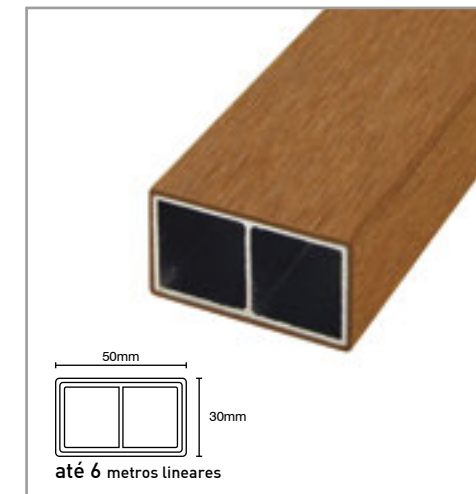
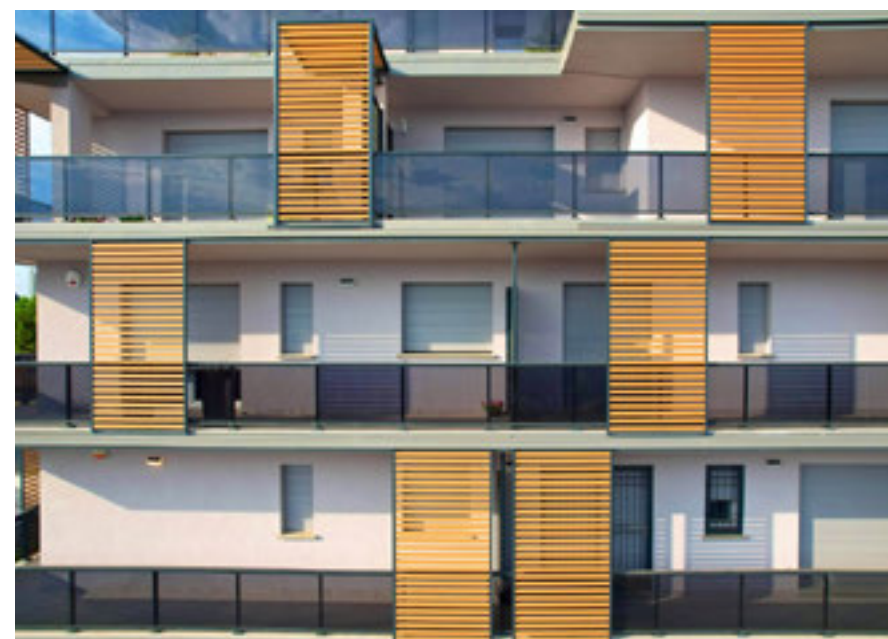

Viga Alveolar ALU/BPC **D18/25.2 ml**  
 Série: **Fachada Vigas**  
 Ref.: RDSTLS09MK 



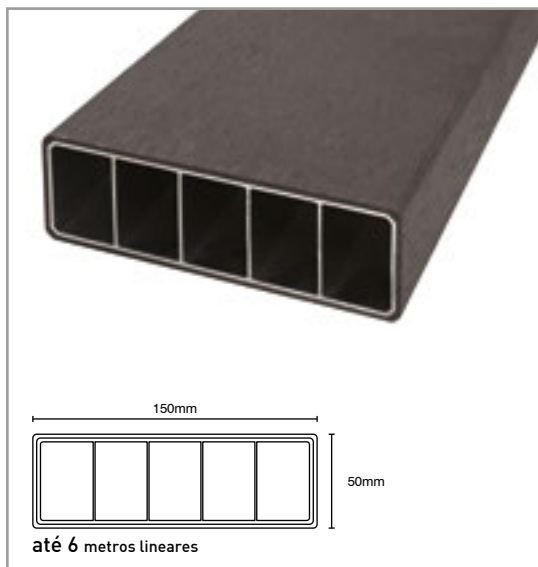

Viga Alveolar ALU/BPC **D58/81.2 ml**  
 Série: **Fachada Vigas**  
 Ref.: RDSTLS02SIL

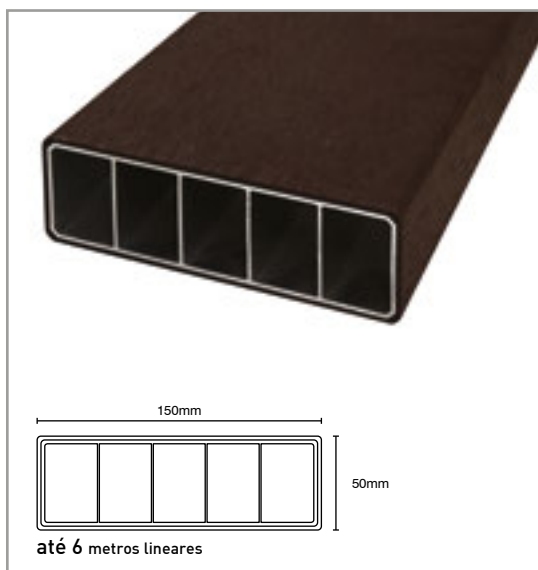

Viga Alveolar ALU/BPC **D58/81.2 ml**  
 Série: **Fachada Vigas**  
 Ref.: RDSTLS02CHOC

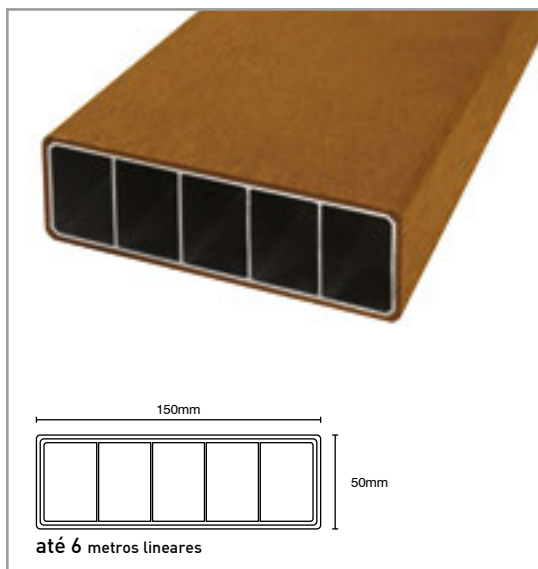

Viga Alveolar ALU/BPC **D58/81.2 ml**  
 Série: **Fachada Vigas**  
 Ref.: RDSTLS02MK

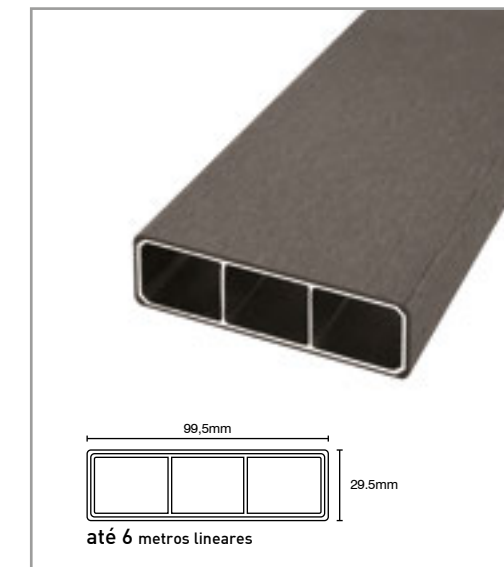

Viga Alveolar ALU/BPC **D28/39.2 ml**  
 Série: **Fachada Vigas**  
 Ref.: RDSTLS01XSIL



Viga Alveolar ALU/BPC **D28/39.2 ml**  
 Série: **Fachada Vigas**  
 Ref.: RDSTLS01XCHOC



Viga Alveolar ALU/BPC **D28/39.2 ml**  
 Série: **Fachada Vigas**  
 Ref.: RDSTLS01XMK





# DIAGRAMA DE INSTALAÇÃO

INSTALLATION CHART / SCHEMA D'INSTALLATION

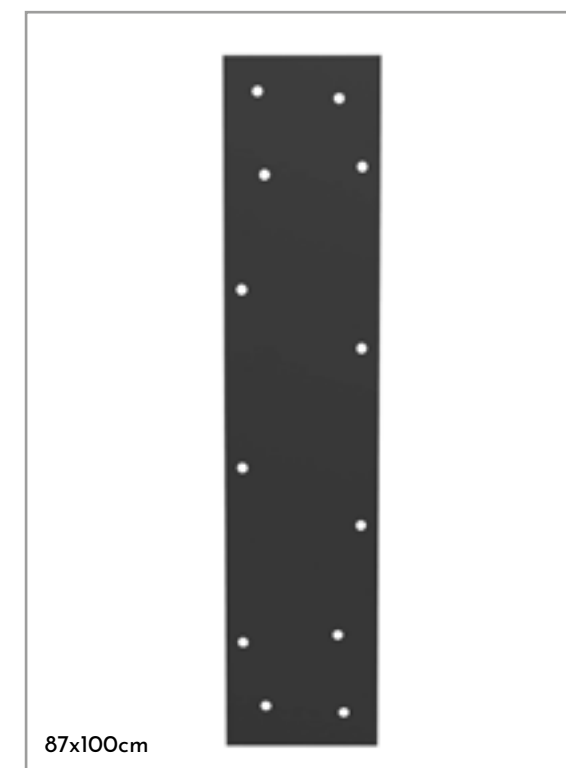
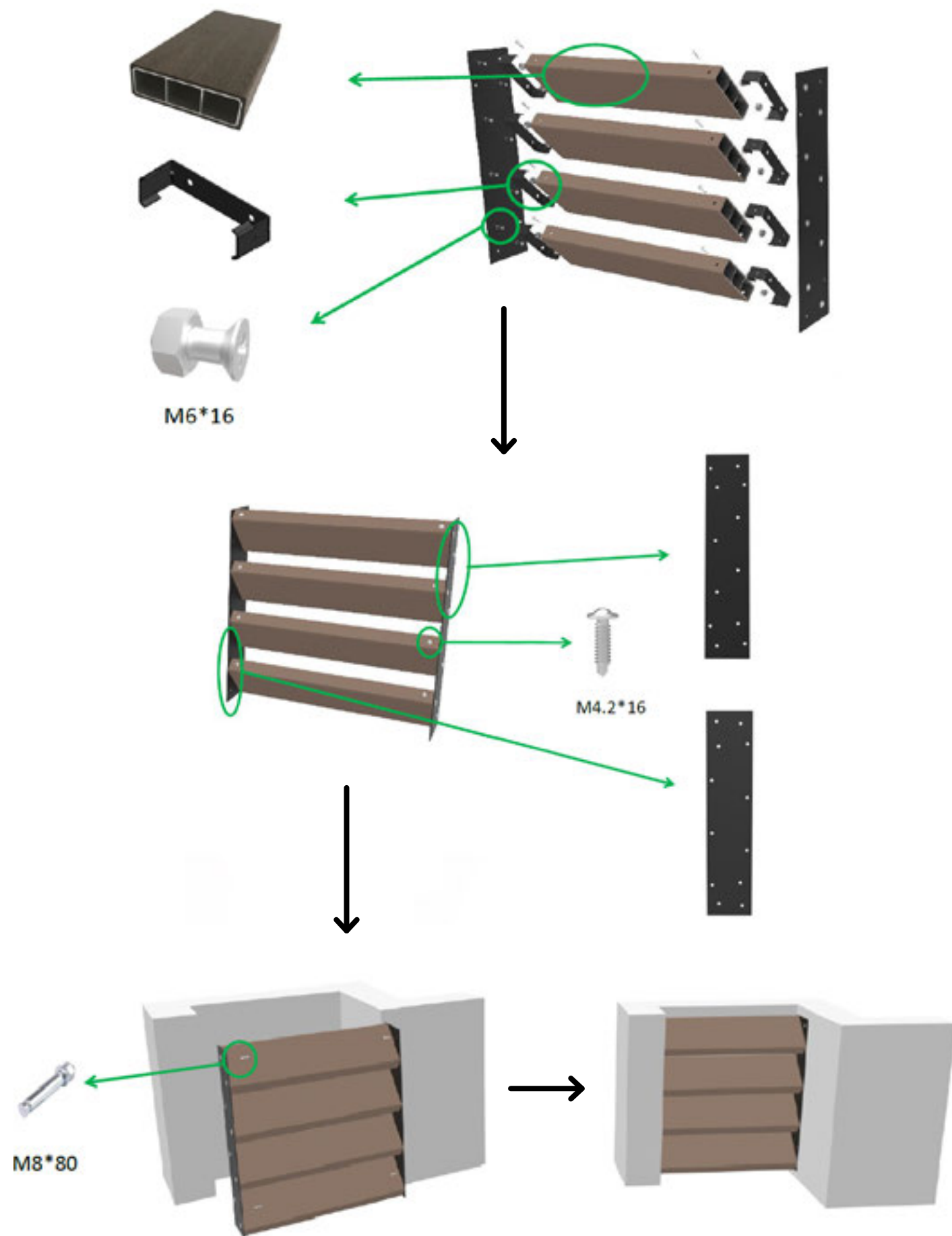

Placa metal Esquerda

D32/45 unit

Série: Fachada Vigas Alveolares

Ref.: RDST13L23ESQ

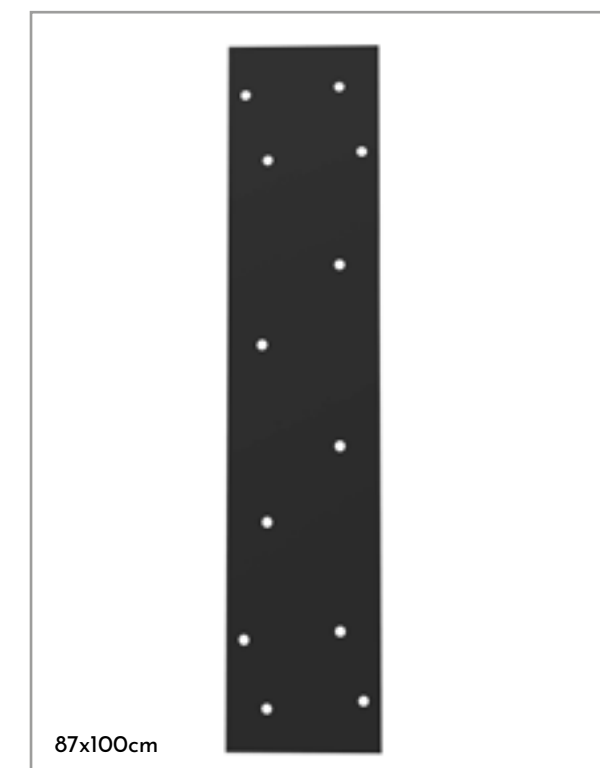

Placa metal Direita

D32/45 unit

Série: Fachada Vigas Alveolares

Ref.: RDST13L24DIR



Suporte de inserção

D3/4,2 unit

Série: Acessórios Vigas Alveolares

Ref.: RDST13L18



Parafuso de porca

D0,25/0,35 unit

Série: Acessórios Vigas Alveolares

Ref.: RDSTM616B



Parafuso de cabeça plana

D0,10/0,14 unit

Série: Acessórios Vigas Alveolares

Ref.: RDSTM4216



Parafuso de expansão

D1,4/1,96 unit

Série: Acessórios Vigas Alveolares

Ref.: RDSTM880C







## PARÂMETROS TÉCNICOS

Technical Features | Paramètres Techniques  
Technische Daten | Parámetros Técnico

## Mosaics

**PT** - Muitos dos artigos deste catálogo são produzidos em pedra natural. Recomendamos que utilize sempre um impermeabilizador/celante das melhores marcas do mercado. Os itens deste catálogo de mosaicos são manufacturados ou produzidos com processos semi-industriais: diferenças na cor e no tom são típicos e inevitáveis nestes produtos.

A maioria dos mosaicos colados em rede podem ser facilmente cortados em tiras com uma tesoura de forma a poder elaborar faixas decorativas.

Pastilhas espelhadas, como a "Lady", não podem ser aplicadas em áreas submersas por água.

Desaconselhamos a aplicação de pastilhas pintadas, como a referência "Vogue", em zonas com constante contacto com água, como por exemplo chuveiros.

Corte: Para cortar peças de pastilha de vidro recomenda-se que se utilize um serra de corte com disco húmido. Para cortar vidro recomenda-se um serra de diamante para vidro de primeira qualidade. Para outros mosaicos como cerâmica, pedra natural e metal use uma serra de diamante standard.

Selante: Pastilhas que contêm elementos em pedra natural devem ser selados antes da aplicação da junta. Use um selante de excelente qualidade e com boa penetração para um aspecto mais natural. Para escurecer ou iluminar os elementos naturais de pedra use um selante de realce. Nunca deixe o selante secar sobre vidro, cerâmica ou metal. Cuidado e limpeza: Use um pano suave ou uma esponja para limpar com água morna e um detergente não abrasivo

**EN** - Many items in this catalogue are made in natural stone. We always recommend to carry out a protective/sealing treatment of the best brands in commerce. The items in this catalogue are often man-made or semi-industrial decors: differences in colour/shade are typical of the product and unavoidable.

Most of the mesh-mounted mosaics in this catalogue can be easily cut in strips with a cutter or scissors.

Mirror mosaics, for example like "Lady" series, cannot be installed in areas submerged in water.

We advise against the application of painted mosaics, such as "Vogue" reference, in areas of constant contact with water, as for example showers.

Cutting: A wet saw is recommended to cut mosaic tiles. a premium glass diamond blade is recommended for glass cutting. Other mosaics such as in ceramic, natural stone or metal, use a standard diamond blade.

Sealing: Mosaics containing natural stone should be sealed prior to grouting. Use a premium penetrating sealer for a natural look. To darken and highlight the natural elements of the stone, use a stone enhancing sealer. Never allow sealers to dry on glass, glazed ceramic or glass.

Care and cleaning: Use a soft cloth or sponge with warm water or non-abrasive mild detergent.

**FR** - Beaucoup d'articles de ce catalogue sont en pierre naturelle. Il est recommandé d'appliquer un traitement protecteur/imperméabilisant de marque de référence sur le marché. Les mosaïques sont fabriquées à partir de processus semi-industriels: C'est pourquoi les différences de tons inhérentes au produit sont inévitables.

La plupart des feuilles de mosaïque sur trame présentées dans le catalogue, peuvent être facilement coupées avec un cutter ou bien simplement avec l'aide d'un ciseaux. Les Mosaïques en miroir, par exemple comme "Lady", ne peuvent être appliquées dans une zone immergée d'eau.

Nous déconseillons l'application de mosaïques peintes, comme la réf "Vogue" dans les zones de contact permanent avec l'eau, tels que les douches.

Pour la coupe: Il est recommandé d'utiliser une scie à eau pour couper la mosaïque en céramique. On recommande l'utilisation d'un disque diamant de première qualité pour couper le verre. Pour les autres types de mosaïques, comme la céramique, la pierre naturelle et le métal, on pourra utiliser un disque diamant standard. Pose scellée: Les mosaïques contenant de la pierre naturelle doivent être scellées avant l'application du joint. Utilisez un scellant spécialement conçu pour la pierre naturelle qui mettra en valeur le produit. Ne jamais laissez le produit scellant sécher sur du verre, de la céramique vernie ou du métal. Entretien et Nettoyage: Utilisez un linge doux ou une éponge avec de l'eau tiède ou un détergent doux non abrasif.

**ES** - Muchos de los artículos en este catálogo se producen en piedra natural. Le recomendamos que utilice siempre un impermeabilizador / celante independientemente de la zona en la que se aplicarán, siempre use productos de las mejores marcas en el mercado. Los elementos de este catálogo de mosaico son hechos a mano o producidos en procesos semi-industriales: diferencias en el color y en el tono son típicos e inevitable en estos productos.

La mayoría de los mosaicos pegados red pueden ser fácilmente cortados en tiras con tijeras a fin de hacer tiras decorativas. Mosaicos con espejo, como los mosaicos "Lady" no se pueden instalar en las zonas sumergidas en agua.

Corte: Para cortar baldosas de mosaico se recomienda una sierra de corte húmedo. Para cortar vidrio se recomienda una hoja de diamante para vidrio de primera calidad.

Para otros mosaicos, como cerámica, piedra natural y metal, use una hoja de diamante estándar.

Sellado: Los mosaicos que contengan piedra natural se deben sellar antes de aplicar la lechada de cemento.

Escoja un sellador penetrante de primera calidad para obtener un aspecto natural. Un sellador que realza la piedra oscurecerá y resaltará las características naturales de la piedra. Nunca permita que los selladores sequen sobre vidrio, cerámica esmaltada o metal.

Cuidado y Limpieza: Use una esponja o paño suave con agua tibia o cualquier detergente suave no abrasivo. Desaconsejamos el uso de mosaicos pintados, como la referencia "Vogue", en áreas de contacto constante con el agua, tales como duchas.

**DE** - Viele Artikel in diesem Katalog sind aus Naturstein. Unabhängig von ihrem Einsatzbereich müssen alle Artikel nach der Verlegung einer Schutzbehandlung/Imprägnierung von bester Qualität, welche auf dem Markt erhältlich sind. Die Artikel in diesem Katalog sind handwerklich gefertigte Decore oder nur teilweise industriell hergestellt worden. Dies bedeutet, dass die Unterschiede betreffend den Farbton typisch und unvermeidbar sind. Um Streifen verschiedener Abmessungen zu erhalten, lässt sich der grösste Teil der auf Netz geklebten Mosaik leicht mit einem Cutter oder mit einer einfachen Schere schneiden.

Spiegelmosaik, wie z.B. die "Lady", können nicht unter Wasser angebracht werden. Wir raten von der Anwendung der bemalten Mosaiken, wie z.B. die "Vogue", in Bereichen mit ständigen Wasserkontakt, z.B. Duschen ab.

Schneiden: Verwenden Sie einen Nassschneider, um die Mosaik zu schneiden. Eine Glas-Diamant-Trennscheibe ist ebenfalls empfehlenswert. Für weitere Mosaik wie Keramik, Naturstein und Metall benutzen Sie ein Standard-Diamantblatt.

Versiegelung: Mosaik mit naturstein sollten vor der Verlegung versiegelt werden. Geeignet sind alle handelsüblichen Versiegelungen für Naturstein. Lassen sie niemals die Versiegelungen auf dem Glas trocknen sowie auf glasierter Keramik oder Metall.

Pflege und Reinigung: Verwenden sie ein weiches Tuch oder Schwamm mit warmen Wasser oder ein mildes Scheuermittel.

## Guia de aplicação para pastilha

Application guide for mosaic | Guide pour l'application de la mosaïque | anwendungshandbuch fuer Mosaik | Guía de aplicación para mosaico

**PT** - Para peças em metal ou vidro USE COLA/JUNTA SEM AREIA, é importante perceber que quaisquer materiais abrasivos ou produtos químicos podem riscar a superfície das peças. Para pedra natural e cerâmica utilize cola/junta com areia.

**EN** - Tiles with metal or glass - USE UNSANDED GROUT, it's very important to understand that any abrasive materials or chemical products can scratch the material surface. Natural Stone and ceramic - USE SAND GROUT

**FR** - Pour les carreaux avec du métal et du verre - UTILISEZ UN JOINT SANS SABLE, notez que les matériaux abrasifs et les produits chimiques peuvent rayer la surface des carreaux. Natural Stone and ceramic - USE SAND GROUT

**DE** - Für Fliesen mit Metall-oder Glas - Verwenden Sie für Glasfliesen geeignete ungesandete Feinfugenmassen, Hierbei ist sehr wichtig, keine Scheuermittel oder chemikalien zu benutzen, da sie die Oberfläche der Fliese zerkratzen könnten. Naturstein und Keramik - Sie können herkömmlich Fugenmasse verwenden, die vom Hersteller für diese Anwendungen vorgesehen sind.

**ES** - Baldosas con metal o vidrio - USE LECHADA DE CEMENTO SIN ARENA, Es muy importante comprender que todo material químico o abrasivo puede rayar la superficie de su baldosa. Piedra natural y cerámica - USE LECHADA DE CEMENTO CON ARENA



É muito importante que a superfície das paredes e pavimentos esteja perfeitamente nivelada para obter um acabamento excelente.

The surface, walls, floors must be perfectly smooth and leveled, to obtain the perfect finish.

Afin d'obtenir une finition parfaite il est préférable que la superficie, les murs, les sols, soient parfaitement lisses et plans.

Überprüfen Sie, ob die Bodenfläche eben ist. Es ist sehr wichtig um eine hervorragende Verarbeitung zu erhalten.

Es muy conveniente que la superficie, paredes, suelos estén perfectamente lisas y mestreadas, para obtener un acabado perfecto.

Ajustar e colocar a rede sobre o suporte devidamente untado com cola.

Adjust the plate and place on the base spread with glue.

Ajuster et poser la plaque sur le support enduit de colle.

Passen Sie das Netz an und setzen Sie es auf den Untergrund ausreichend geschmiert mit Klebstoff.

Ajustar y aplicar la placa sobre el soporte untado con cola.



Pressionar com a ajuda de uma talocha de borracha ou madeira.

Press with the help of a wood or rubber trowel.

Faire pression à l'aide d'une taloche en bois ou caoutchouc.

Mit einen Putzbrettchen aus Gummi oder Holz Druck machen.

Presionar con la ayuda de una llana de madera o caucho.

Para efectuar as juntas, aplicar uma camada de produto especial para juntas, com uma espátula de borracha.

To join, apply a layer of the especial joining product with a rubber spatula.

Pour réaliser les joints, étendre une couche de produit spécial pour jointures à l'aide d'une spatule en caoutchouc.

Die Fugen sollen mit einen speziellen Produkt fuer Fugen und einer Gummispachtel angebracht werden.

Para efectuar las juntas, extender una barboleta de producto especial para juntas, con una espátula de caucho.

Limpar com uma esponja húmida. Enxaguar e secar com um pano bem seco.

Clean with a damp sponge, rinse and dry with a very dry cloth.

Nettoyer avec une éponge humide. Rincer et sécher avec un chiffon bien sec.

Entfernen Sie die restlichen Abfälle mit einem nassen Tuch. Spülen und Trocknen mit einem trockenen, weichen Tuch.

Limpiar con una esponja húmeda. Enjuagar y secar con un trapo bien seco.

Se seguir estas instruções obterá um resultado excelente.

If you have followed these instructions, you will achieve optimal results.

Si vous avez suivi ces instructions, votre travail sera moindre et votre rendement s'améliorera sensiblement.

Wenn Sie diese Schritte folgen, erhalten Sie einen hervorragenden Verarbeitung.

Si ha seguido estas instrucciones, su trabajo será menor y su rendimiento mejorará sensiblemente.





## LÂMINAS / EXTRA LARGE SLABS / DALLE GRAND FORMAT GROSSFORMATIGE FLIESEN / LÁMINAS PORCELÁNICAS

Recomendações para a manutenção de materiais polidos.

O material polido tem maior predisposição ao aparecimento de manchas devido aos pequenos microporos que se originam durante o processo de polimento. Além disso, os polidos não toleram ácidos e álcalis altamente concentrados, como ácido clorídrico, ácido láctico e hidróxido de potássio. Portanto, é recomendado para sua manutenção, o uso de ácidos de baixa concentração ou produtos de limpeza doméstica.

Os nossos produtos cerâmicos podem ser considerados acabamentos finais na construção. Recomenda-se colocá-los apenas quando o resto da obra estiver concluída: estruturas, alvenarias, pisos, tetos, instalações..., especialmente produtos para pisos porcelânicos. Isso minimiza os danos que o produto de cerâmica pode sofrer por ser colocado muito cedo.

Quando os produtos porcelânicos são colocados antes do acabamento final da construção, recomenda-se dar uma proteção adequada ao pavimento com tela de proteção Rubiprotect, papelão, ou outro produto que o proteja.

Polished tiles recommendations of use and maintenance.

The polished material has a greater predisposition to the appearance of stains due to the small micro-pores that originate during the polishing process. Likewise, polishes do not tolerate high concentration acids and alkalis such as hydrochloric acid, lactic acid and potassium hydroxide. Therefore, the use of low concentration acids or household products is recommended for maintenance.

Our ceramic products should be considered as a construction finishing product. Its installation is only recommended when the rest of construction works have been already finalised: structures, masonry, flooring, ceiling, internal systems..., especially for the porcelain floor tiles. In this way potential damages that may undergo the ceramic product will be minimised for being installed too early.

When the ceramic products are installed before the construction is finalised, it is highly recommended to give the floor a proper protection, either using cardboard, Rubiprotect protective layer or any other product that protects it.

Recommandations pour l'entretien des matériaux polis.

Les matériaux polis sont plus sensibles à l'apparition de tâches due aux petits micropores survenant pendant le processus de polissage. De même, ils ne tolèrent pas les acides et alcalis de concentration élevés tel que l'acide chlorhydrique, l'acide lactique et de l'hydroxyde de potassium. Par conséquent, il est recommandé pour l'entretien, l'utilisation d'acides à faible concentration ou des produits de nettoyage ménagers.

Nos produits céramiques peuvent être considérés comme la touche finale dans le processus de la construction. Nous recommandons de les installer seulement quand le reste des travaux constructifs ont été réalisés: structures, maçonnerie, chape, plafonds, installations..., en particulier les produits de grès cérame pour sol. Nous éviterons de cette façon les éventuels dégâts pouvant affecter le produit céramique dès à son installation prématurée.

Lorsque les produits céramiques sont installés avant de terminer la construction, nous recommandons de les protéger convenablement avec un carton, une couche protectrice Rubiprotect ou tout autre produit pouvant les protéger.

Verwendungs- und Pflegeempfehlung für polierte Fliesen.

Das polierte Material neigt zur Fleckenbildung aufgrund der Mikroporen, welche während des Polierprozesses entstehen. Die Politur verträgt keine hochkonzentrierten Säuren und Laugen wie beispielsweise Salzsäure, Milchsäure und Kaliumhydroxid. Aus diesem Grund wird die Verwendung von schwachen Säuren und Haushaltsprodukten zur Pflege empfohlen.

Man kann unsere Keramikfliesen als Abschluss einer Bauphase betrachten. Wir empfehlen, die Fliesen erst zu verlegen, wenn der Rest der Arbeiten abgeschlossen ist: strukturelle Arbeiten, Mauerwerk, Fußboden, Decken, Installationsarbeiten..., insbesondere bei Bodenfliesen. Dadurch werden Schäden bei einer zu frühzeitigen Verlegung der Fliesen vermieden.

Wenn die Fliesen vor Abschluss der Bauarbeiten verlegt werden, empfehlen wir, den Boden mit Karton oder einem anderen entsprechenden Schutz zu bedecken.

Recomendaciones para el mantenimiento de los materiales pulidos.

El material pulido tiene mayor predisposición a la aparición de manchas debido a los pequeños microporos que se originan durante el proceso de pulido. Asimismo, los pulidos no toleran los ácidos y álcalis de alta concentración tales como el ácido clorhídrico, ácido láctico e hidróxido potásico. Por lo tanto, se recomienda para su mantenimiento, el uso de ácidos de baja concentración o productos domésticos de limpieza.

Nuestros productos cerámicos se pueden considerar acabados finales en la construcción. Se recomienda colocarlos solo cuando el resto de los trabajos constructivos hayan finalizado: estructuras, mampostería, solados, techos, instalaciones..., en especial los productos porcelánicos para suelos. De este modo se minimizan los daños que pueda experimentar el producto cerámico por haber sido colocado demasiado pronto.

Cuando los productos porcelánicos son colocados antes de finalizar la construcción, se recomienda darle una adecuada protección al pavimento con cartón, una capa Rubiprotect u otro producto que lo proteja.



## SUPER BLACK, WHITE, GREY

Não podem ser usados produtos abrasivos na limpeza desta referência.

Artigos como esfregão, palha de aço, Cif, lixívia, ou qualquer tipo de raspador ou espátula para remover detritos à superfície das peças irão danificar DEFINITIVAMENTE a superfície das peças.

A Rubicer não se responsabiliza por danos causados nas peças se estas advertências não forem respeitadas.

Nas limpezas de fim de obra devem ser usados produtos para esse fim e nunca produtos domésticos.

Aconselhe-se no local de compra da cerâmica sobre o melhor produto para a limpar.

## SIMBOLOGIA

Symbology, Symbologie, Symbologje, Simbologia

PE	Parcelamento Esmaltado Glazed Porcelain Porcelane Émailée Glasiertes Feinsteinzeug Porcelánico Esmaltado	EXT	Acabamento anti-derrapante Anti slip finish Antirutschiger Endbearbeitung Acabado antideslizante
FB	Tudo Massa Full body Plaine Masse Ganzkörper Verarbeiteter Toda Masa	RET	Piso Anti-derrapante Anti slip floor Sal anti-glisement Rutschfestes Pavimento anti-derrapante
MC	Massa Colorada Coloured Masse Pâte Colorée Durchgefärbtes Feinsteinzeug Coloración en Masa	BOLD	Areia Boleada Bald site Bord orandi Gerandete Rand Borde Redondeada
PB	Plata Branca White Body Pâte Blanche Weißschichtig Pasta Blanca		

## CONSELHOS PARA APLICAÇÃO DE RÉGUAS PORCELÂNICAS

PRODUCT PLACEMENT TIPS FOR RECTANGULAR PRODUCTS  
CONSEILS D'APPLICATION POUR LES PRODUITS RECTANGULAIRES  
HINWEISE ZUR ANWENDUNG DER PORCELANIC PLATTEN  
CONSEJOS DE COLOCACIÓN PARA PRODUCTOS RECTANGULARES

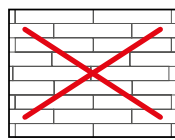

Meia peça não aconselhável  
Half piece not advisable  
Demi pièce ne pas conseillé  
Halbes Teil durfte nicht benutzt werden  
Media pieza no aconsejable

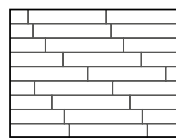

sequencial  
sequential • sequencial  
sequentiell • secuencial  
2 - 5 - 7,5 - 10 - 12,5 - 15 - 18cm

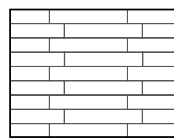

entre 2 - 18cm  
between 2 - 18cm  
entre 2 - 18cm  
zwischen 2 - 18 cm  
entre 2 - 18cm

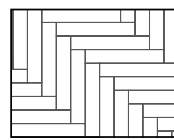

90°

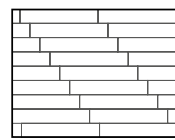

Max. 18cm

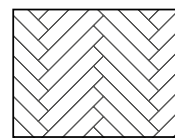

45°



**NÃO SE ACEITAM RECLAMAÇÕES DEPOIS DE CERÂMICAS, MOSAICOS, PEDRAS E OUTROS ITENS DESTA CATEGORIA SEREM APLICADOS.**

No claims accepted after ceramic tiles, mosaics, natural stone and others are fixed.

Aucune réclamation ne sera acceptée après la pose du carrelage, de mosaïque et de pierre naturelle.

No se aceptan reclamaciones después de estar aplicado las cerámicas, los mosaicos, piedras y otros.

Nach dem Verlegen der Fliesen, Mosaik und Naturstein werden keine Reklamationen angenommen

AS VARIANTES A QUE O PROCESSO DE PRODUÇÃO DE CERÂMICA E DE MOSAICOS ESTÁ SUJEITO PODEM PROVOCAR LIGEIRAS VARIAÇÕES DE TONALIDADE EM RELAÇÃO AO PADRÃO DE COR ESTABELECIDO.

A RUBICER RESERVA-SE O DIREITO DE ALTERAR OU ELIMINAR, TOTAL OU PARCIALMENTE, QUALQUER SÉRIE, REFERÊNCIA, PREÇO OU ESPECIFICAÇÃO TÉCNICA CONTIDA NESTE CATALOGO.

AS CORES IMPRESSAS NESTE CATALOGO SÃO APENAS INDICATIVAS.

The variants to which the production process is exposed can cause slight variations on shade to the fixed standard colours.

RUBICER has right to change or eliminate, totally or partially, any series, reference, price or technical specification mentioned in this catalogue.

Printed colours in this catalogue are for guidance purposes only.

Les variantes auxquelles le processus de production est soumis peuvent provoquer des légères variations de tonalité par rapport au standard établie.

RUBICER se donne le droit de changer ou supprimer, partiellement ou totalement, toute référence, prix ou spécification technique mentionnées sur ce catalogue.

Les couleurs présentées sur ce catalogue ne sont qu'indicatives.

Die Varianten zu denen das Produktionsverfahren ausgesetzt wird können leichte Tonalitätsabweichungen verursachen im Vergleich zur festgestellte Standardfarbe.

RUBICER behält sich das Recht irgendeine in diesem Katalog enthaltene Referenz, preis oder technische Angabe, ganz oder teilweise, zu ändern oder zu beseitigen.

Die Farben in diesem Katalog sind nur zu Ihrer Orientierung.

Las variantes a que el proceso de producción de cerámica esta sujeto, pueden provocar ligeras variaciones de tonalidad en relación al patrón del color establecido.

RUBICER se reserva el derecho de alterar o eliminar, total o parcialmente, cualquier serie, referencia, precio o especificación técnica contenida en este catálogo.

Los colores impresos en este catálogo son meramente indicativos.

## APLICAÇÃO, LIMPEZA E MANUTENÇÃO DE PISOS CERAMICOS

installation, cleaning and maintenance | application, nettoyage et entretien | verlegen, reinigung und instandhaltung | limpieza y mantenimiento

PT • GRÉS PORCELÂNICO • GRÉS PORCELÂNICO TÉCNICO • GRÉS FINO PORCELÂNICO TÉCNICO • DUPLO CARREGAMENTO  
EN • PORCELAIN TILES • HOMOGENEOUS TECHNICAL PORCELAIN TILES • HOMOGENEOUS TECHNICAL PORCELAIN TILES • DOUBLE LOADED  
FR • GRÉS CÉRAMÉ • GRÉS CÉRAMÉ TECHNIQUE • GRÉS CÉRAMÉ PLEINEMENT VITRIFIÉ TECHNIQUE • DOUBLE CHARGEMENT  
DE • FEINSTEINZEUGFLIESEN • TECHNIK UNGLASIERTES FEINSTEINZEUG • TECHNIK UNGLASIERTES FEINSTEINZEUG • DOPPELADUNG  
ES • GRÉS PORCELÁNICO • GRÉS PORCELÁNICO TÉCNICO • GRÉS FINO PORCELÁNICO TÉCNICO • DUPLO CARGAMIENTO

TIPO DE SUJIDADE TYPE OF STAIN TYPE DE SALETÉ ART DER VERSCHMUTZUNG TIPO DE SUCIEDAD	DETERGENTE OU SOLVENTE ACONSELHADO TYPE OF DETERGENT ADVISED BY RUBICERAMIC TYPE DE DÉTERGENT OU SOLVANT CONSEILLÉ EMPFOHLENES REINIGUNGSMITTEL DETERGENTE O DISOLVENTES ACONSEJADOS	PRODUTOS RECOMENDADOS POR: PRODUCTS ADVISED BY: PRODUIT RECOMMANDÉ PAR: EMPFEHLENDE REINIGUNGSMITTEL VON: PRODUCTOS RECOMENDADOS PELA: FILA
Depósitos / eflorescências de: Calcário, Tinta de tinteiro, Ferrugem, Oxidação, Cimento Calcareous matter/ deposits: Ink, Rust, Oxides, Mortar Dépôts/ efflorescences: Calcaire, Encre, Rouille, Oxydation, Mortier Kalkablagerungen/ Ablagerungen: Tinte, Rost, Oxydation, Mörtel	Detergente com base ácida: Ácido muriático, Ácido nítrico, Ácido sulfúrico, Ácido oxálico Calcareous matter/ deposits: Ink, Rust, Oxides, Mortar Acide: Acide muriatique, Acide nitrique, Acide sulfurique, Acide oxalique Säurehaltiges Reinigungsmittel: Salzsäure, Salpetersäure, Schwefelsäure, Oxalsäure Detergente con base ácida: ácido muriático/ ácido nítrico/ ácido sulfúrico/ ácido oxalico	Detertec
Depositos / eflorescencias de carbonato cálcico, tinta de tinteiro, herrumbre, oxidación, cemento	Detergente con base alcalina: Soda cáustica, Potassa Détergents Alkaline: Caustic soda, potash Caustique, Potasse	Fila PS/87 Fila SR/95
Cerveja / vinho, Gelado / café / chá, Gordura vegetal e animal, Urina, Vômito Beer/ wine, Ice cream / coffee / tea, Vegetable and animal fat, Urine, Vomit Bière/ vin, Glace / café / thé, Graisses végétales et animales, Urine, Vomissement Bier/ Wein, Eiscreme / Kaffee / Tee, tierische oder pflanzliche Fette, Urin, Erbrochene Cerveza / vino, helado y café, té, grasa vegetal y animal, orina, vómito	Detergente com base alcalina: Soda cáustica   potasa Détergents Alkaline: Caustic soda, potash Caustique, Potasse Säurehaltiges Reinigungsmittel: Ätznatron, Kohlensäures Kali Detergente con base alcalina: sosa cáustica   potasa	Fila PS/87 Fila SR/95 Fila Sol (óleo, graxa / grease, shoe polish / huile de graissage, cire / Maschinenöl, Schmiere) Fila Solv (betumes, ceras, resinas / putties, wax, resins / betume, cires, resines / Bitumen, Wachs, Harz / alquitrán   ceras   resinas)
Marcas de pneus, Tintas resinosas ou esmalte, Óleo, Vernizes, Graxa, Lápiz de cera, Tinta de cabelo, Baton, Betumes, Ceras, Resinas Rubber, Paints, Grease, Varnish, Shoe polish, Wax crayon, Hair dye, Lipstick, Putties, Wax, Resins Caoutchouc de pneus, Peinture, Huile de graissage, Vernis, Cire, Crayon de cire, Teiture pour les cheveux, Rouge à lèvres, Betume, Cires, Resines Gummi, Harz oder Lack, Maschinenöl, Lack, Schmiere, Wachs, Wachs, Wachs, Lippenstift, Bitumen, Wachs, Harz	Solventes: Trielina, Diluente, Aguarrás, Acetona Solvent: Turpentine, Oil of turpentine, Thinner, Trichloroethylen Solvants: Trichloréthylène, Dissolvant, Acétone térébenthine Lösungsmittel: Trichloräthylen, Nitroverdüner, Terpentin, Azeton Disolventes: trielina   diluyente   aguarrás   acetona	Fila PS/87 Fila SR/95 Fila Sol (óleo, graxa / grease, shoe polish / huile de graissage, cire / Maschinenöl, Schmiere) Fila Solv (betumes, ceras, resinas / putties, wax, resins / betume, cires, resines / Bitumen, Wachs, Harz / alquitrán   ceras   resinas)
Canetas de feltro, Ketchup, Coca-cola, Vinagre, Azul metileno Felt tipped pen, Ketchup, Coke, Vinegar, Methylene blue Feutres, Ketchup, Coca-cola, Vinaigre, Bleu de méthylène Filzstift, Ketchup, Coca-Cola, Essig, Methylene blau Rotuladores, ketchup, coca cola, vinagre, azul metileno	Detergente com base alcalina, Ácido Alkaline, Acid Détergent alcalin, Acide Alkalisch, säurehaltiges Reinigungsmittel Detergente con base alcalina   ácido	Fila PS/87 Fila SR/95
Tintas de grafiti Graffiti Graffiti Graphitfarben Pintadas de grafiti	-	Fila Nopaint Star
Sujidade nas juntas Dirt on grouting joints Sallitures sur les joints Fugenschmutz Suciedad en las juntas	-	Fuganet
Manutenção quotidiana Daily cleaning Maintenance journalière routine - Reinigung Manutención cotidiana	Detergente comum Normal detergent Détergent normal Gewöhnliches Reinigungsmittel Detergente común	Fila Cleaner

Usar com muita prudência ácidos e outros produtos químicos concentrados. Seguir atentamente as instruções dos fabricantes indicadas nos embalagens.  
Os produtos com acabamento polido / semi-polido devem ser impermeabilizados logo após a aplicação e antes de serem rejuntados. Recomendamos que se informe e caso necessário contacte o fabricante antes de selecionar um produto, para se assegurar que escolha o produto certo para a utilização em vista.

Whenever working with acids or other strong cleaning chemicals use them with great caution. Read product label carefully and always follow manufacturers directions and precautions.  
The products with polish/ semi-polished finishing, should be immediately waterproofed after the laying of the tiles and before the grouting.  
We recommend that one should search for information and if necessary ask the manufacturer for advice before you select a product to make sure that you select the right tile for the intended use.

Agir avec prudence dans l'emploi d'acides ou d'autres produits chimiques concentrés. Suivre attentivement les instructions des fabricants indiquées sur les emballages.  
Les produits avec des finitions polis/ semi-polis doivent être imperméabilisés juste après leur application et avant de remplir les joints. Avant de sélectionner un ou plusieurs produits, nous recommandons la prise d'information et si nécessaire la prise de contact auprès de notre fabricant afin de s'assurer que ce choix est en accord avec l'utilisation préétendue.

Beim Umgang mit Säuren oder anderen Chemikalien ist Vorsicht geboten. Die Herstellerhinweise auf den Packungen strikt befolgen.  
Die Produkte mit polierter/ teilpolierter Oberfläche müssen sofort nach dem Verlegen und vor dem Verfugen imprägniert werden. Bitte beachten Sie die Anwendungsanweisungen der Hersteller für Imprägniermittel. Wir empfehlen sich zuerst sorgfältig zu erkundigen und wenn nötig den Hersteller zu kontaktieren bevor Sie die Produkte aussuchen um sicher zu sein, daß Sie die, für den Gebrauch, geeignete Fliese auswählen.

Usar con mucha prudencia ácidos o de otros químicos concentrados. Seguir atentamente las instrucciones de los fabricantes, indicados en los embalajes.  
Los productos con acabado en pulido/ semi pulido deben ser impermeabilizados luego de la aplicación y antes de ser rejuntados. Recomendamos que se informe cuidadosamente y si es necesario contacte con el fabricante antes de seleccionar un producto, para asegurar que se escoge el producto correcto para el uso al que va destinado.



**NUOVE NORME ISO**

New ISO standards - Nouvelles Normes ISO

Neue ISO Normen - Neuvas Normas ISO

Новые нормы ISO

**DEFINIZIONE E CLASSIFICAZIONE**

DEFINITION AND CLASSIFICATION - DEFINITION ET CLASSIFICATION

DEFINITION UND KLASSIFIZIERUNG - DEFINICIÓN Y CLASIFICACIÓN

ОПРЕДЕЛЕНИЕ И КЛАССИФИКАЦИЯ

**Tabella 1a**  
Table - Tab.  
Table - Tabla

<b>CARATTERISTICHE E REQUISITI (specifica tecnica)</b>	<b>GRUPPO - GROUP</b> GROUPE - GRUPE - GRUPO - ГРУППА	<b>ISO 13006</b>
<b>CHARACTERISTICS AND REQUISITES (technical specifications)</b>	<b>Bla Bib Blla Blib Blll</b>	
<b>CARACTERÍSTICAS ET QUALITÉS REQUISITES (Specification technique)</b>	<b>Campionamento e criteri di accettazione</b> Sampling and basis for acceptance - Echantillonnage et critères d'acceptation Masterentnahme und Kriterien für die Annahme - Muestreo y criterios de aceptación. Отбор образцов и приемочные критерии	<b>ISO 10545.1</b>
<b>EIGENSCHAFTEN UND VORAUSSETZUNGEN (technische Beschreibung)</b>	<b>Determinazione delle caratteristiche dimensionali e della qualità della superficie</b> Determination of dimensions and surface quality - Détermination des caractéristiques dimensionnelles et de la qualité de la surface Bestimmung der Abmessungseigenschaften und der Qualität der Oberfläche - Determinación de las características dimensionales y de la calidad de la superficie. - Определение размеров характеристик и качества поверхности	<b>ISO 10545.2</b>
<b>CARACTERÍSTICAS Y REQUISITOS (especificaciones técnicas)</b>	<b>Determinazione dell'assorbimento d'acqua, della porosità apparente, della densità relativa apparente e della densità apparente</b> Determination of water absorption, apparent porosity, apparent relative density and bulk density Détermination de l'absorption d'eau, de la porosité apparente, de la densité relative apparente et de la densité apparente Bestimmung der Wasseraufnahme, der scheinbaren Porosität, der scheinbaren relativen Dichte und der scheinbaren Dichte Determinación de la absorción de agua, de la porosidad aparente, de la densidad relativa aparente y de la densidad aparente Определение водопоглощения, кажущейся пористости, удельной кажущейся плотности и кажущейся плотности	<b>ISO 10545.3</b>
<b>ХАРАКТЕРИСТИКИ И ТРЕБОВАНИЯ (технические условия)</b>	<b>Determinazione della resistenza a flessione e della forza di rottura</b> Determination of modulus of rupture and breaking strength - Détermination de la résistance à la flexion et de la force de rupture Bestimmung der Flexionsfestigkeit und der Bruchkraft - Determinación de la resistencia a la flexión y de la fuerza de rotura. Определение прочности при изгибе и разрушающей силы	<b>ISO 10545.4</b>
	<b>Determinazione della resistenza all'urto mediante misurazione del coefficiente di restituzione</b> Determination of resistance to impact by measurement of coefficient of restitution - Détermination de la résistance au choc à travers la mesure du coefficient de restitution - Bestimmung der Stoßfestigkeit durch Messung des Restitutionsfaktors - Determinación de la resistencia a los golpes mediante medición del coeficiente de restitución. - Определение ударпрочности путем измерения коэффициента восстановления	<b>ISO 10545.5</b>
<b>METODI DI PROVA</b>	<b>Determinazione della resistenza all'abrasione profonda per piastrelle non smaltate</b> Determination of resistance to deep abrasion for unglazed tiles - Détermination de la résistance à l'abrasion profonde pour carreaux non émaillés Bestimmung der Tiefenabriebfestigkeit bei nicht glasierten Fliesen - Determinación de la resistencia a la abrasión profunda para azulejos no esmaltados. - Определение сопротивления глубокому истиранию неглазурованной плитки	<b>ISO 10545.6</b>
<b>TESTING METHODS</b>	<b>Determinazione della resistenza all'abrasione superficiale per piastrelle smaltate</b> Determination of resistance to surface abrasion for glazed tiles - Détermination de la résistance à l'abrasion superficielle pour carreaux émaillés Bestimmung der Oberflächenabriebfestigkeit bei glasierten Fliesen - Determinación de la resistencia a la abrasión superficial para azulejos esmaltados - Определение сопротивления глазурированной плитки поверхностному истиранию	<b>ISO 10545.7</b>
<b>METHODS D'ESSAI</b>	<b>Determinazione della dilatazione termica lineare</b> Determination of linear thermal expansion - Détermination de la dilatation thermique linéaire Bestimmung der linearen thermischen Dilatation - Determinación de la dilatación térmica lineal. Определение линейного теплового расширения	<b>ISO 10545.8</b>
<b>PRÜFMETHODEN</b>	<b>Determinazione della resistenza agli sbalzi termici</b> Determination of resistance to thermal shock - Détermination de la résistance aux écarts thermiques Bestimmung der Thermochockfestigkeit - Determinación de la resistencia a los cambios de temperatura. Определение стойкости к перепадам температуры	<b>ISO 10545.9</b>
<b>MÉTODOS DE PRUEBA</b>	<b>Determinazione della dilatazione dovuta all'umidità</b> Determination of moisture expansion - Détermination de la dilatation due à l'humidité Bestimmung der Dilatation durch Feuchtigkeit - Determinación de la dilatación debida a la humedad. Определение расширения, вызванного влажностью	<b>ISO 10545.10</b>
<b>METODY ISPYTANIYA</b>	<b>Determinazione della resistenza al cavillo per piastrelle smaltate</b> Determination of crazing resistance for glazed tiles - Détermination de la résistance à la craquelure pour carreaux émaillés Bestimmung der Haarrissfestigkeit bei glasierten Fliesen - Determinación de la resistencia al cuarteado para azulejos esmaltados Определение стойкости глазурированной плитки к образованию кракелюра	<b>ISO 10545.11</b>
<small>* La sede di ISO/TC189 si è decisa di eliminare il metodo di determinazione della durezza superficiale secondo la scala Mohs, previsto per la norma EN 101, e di sostituirlo con un nuovo metodo.</small>	<b>Determinazione della resistenza al gelo</b> Determination of frost resistance - Détermination de la résistance au gel Bestimmung der Frostfestigkeit - Determinación de la resistencia a las heladas Определение морозостойкости	<b>ISO 10545.12</b>
<small>* According to ISO/TC189 the Mohs scale method of determining surface hardness, prescribed by the EN 101 standard, has been eliminated and substituted with a new method.</small>	<b>Determinazione della resistenza chimica</b> Determination of chemical resistance - Détermination de la résistance chimique Bestimmung der Chemikalfestigkeit - Determinación de la resistencia química Определение химической стойкости	<b>ISO 10545.13</b>
<small>* On a décidé, pour le ISO/TC189, d'éliminer la méthode déterminant la dureté de surface selon l'échelle de Mohs, prévue par la norme EN 101, et de la remplacer par une nouvelle méthode.</small>	<b>Determinazione della resistenza alle macchie</b> Determination of resistance to stains - Détermination de la résistance aux taches Bestimmung der Fleckenfestigkeit - Determinación de la resistencia a las manchas Определение стойкости к образованию пятен	<b>ISO 10545.14</b>
<small>* Bei der ISO/TC189 wurde beschlossen, die Bestimmungsmethode der Oberflächenhärte auf der Mohsskala gemäß EN 101 abzuschaffen und durch eine andere Methode zu ersetzen.</small>	<b>Determinazione del piombo e del cadmio ceduto dalle piastrelle smaltate</b> Determination of lead and cadmium given off by glazed tiles - Détermination du plomb et du cadmium émanant des carreaux émaillés Bestimmung des von glasierten Fliesen freigesetzten Bleis und Kadmiums - Determinación del plomo y del cadmio cedido por los azulejos esmaltados. Определение свинца и кадмия, выделяемого глазурированной плиткой	<b>ISO 10545.15</b>
<small>* En sede de ISO/TC189 se ha decidido eliminar el método de determinación de la dureza superficial según la escala Mohs, previsto por la norma EN 101, y sustituirlo con un nuevo método.</small>	<b>Determinazione delle differenze di colore</b> Determination of colour differences - Détermination de la différence de couleur Bestimmung der Farbunterschiede - Determinación de las diferencias de color Определение цветовых разниц	<b>ISO 10545.16</b>
<small>* При составлении нормы ISO/TC189 было решено устранить метод определения поверхностной твердости по шкале Моиса, предусмотренный стандартом EN101, и заменить его новым методом.</small>	<b>Determinazione del coefficiente di attrito</b> Determination of coefficient of friction - Détermination du coefficient de frottement Bestimmung des Reibungskoeffizienten - Determinación del coeficiente de rozamiento Определение коэффициента трения	<b>ISO 10545.17</b>

Norma Standard Norme Normen Norma	Métodos de Ensaio Test method Méthode d'essai Prüfmethode Método de ensayo	Porcelanato Esmaltado Glazed tiles, Cérame emailé, Glasiert feinsteinzeug, Porcelánico esmaltado		Massa Colorada Mass Colouring, Pâte colorée, Durchgefärbtes feinsteinzeug, Coloración en masa		Pasta Bianca White body, Pâte blanche Weiss-Scherbig, Pasta blanca		Pasta Vermelha Red body, Pâte rouge Rot-Scherbig, Pasta roja		
		valor prescrito fixed value valeur prescrite Vorgeschriebener wert valor prescrito	valor médio mean value valeur moyenne durchschnitts-wert valor médio	valor prescrito fixed value valeur prescrite Vorgeschriebener wert valor prescrito	valor médio mean value valeur moyenne durchschnitts-wert valor médio	valor prescrito fixed value valeur prescrite Vorgeschriebener wert valor prescrito	valor médio mean value valeur moyenne durchschnitts-wert valor médio	valor prescrito fixed value valeur prescrite Vorgeschriebener wert valor prescrito	valor médio mean value valeur moyenne durchschnitts-wert valor médio	
		Dimensões largura e comprimento Dimensions Length and width Dimensions Longueur et largeur Masse Länge und Breite Dimensiones Longitud y anchura	± 0,6% Máx	± 0,4%	± 0,6% Máx	± 0,4%	± 0,5%	± 0,3%	+ 0,6% - 0,3%	± 0,2%
		Rectilindade dos lados Sides straightness Rectitude des arêtes Geractlinigkeit der Kanten Rectilindad de los lados	± 0,5% Máx	± 0,4%	± 0,5% Máx	± 0,4%	± 0,3%	± 0,3%	± 0,3%	± 0,1%
ISO 10545-2		Ortogonalidade Corner squareness Angularité Rechtwinkligkeit der kanten Ortogonalidad de las esquinas	± 0,6% Máx	± 0,4%	± 0,6% Máx	± 0,4%	± 0,5%	± 0,3%	± 0,3%	± 0,25%
		Nivelamento Flatness Planéité Ebenflächigkeit Planeidad	± 0,5% Máx	± 0,4%	± 0,5% Máx	± 0,4%	± 0,5%	± 0,3%	+ 0,8mm - 0,2mm	± 0,2%
		Espessura Thickness Epaisseur Dicke Grosor	± 0,5%	± 0,5%	± 0,5%	± 0,5%	± 10%	6%	± 10%	± 10%
ISO 10545-3		Absorção de água Water absorption Absorption d'eau Wasseraufnahme Absorción de agua	≤ 0,5%	0,05 ± 0,07%	≤ 0,5%	0,05 ± 0,07%	> 10%	14 - 18%	-	< 6%
		<b>Esfuerzo de ruptura Breaking strength</b> Contrainte de rupture Bruchkraft Esfuerzo de rotura	1300 ≥7,5mm	conforme conform conforme gleichmässig conforme	1300 ≥7,5mm	conforme conform conforme gleichmässig conforme	600 ≥7,5mm	conforme conform conforme gleichmässig conforme	-	-
ISO 10545-4		<b>Esfuerzo de ruptura Breaking strength</b> Contrainte de rupture Bruchkraft Esfuerzo de rotura	1300 ≤7,5mm	conforme conform conforme gleichmässig conforme	1300 ≤7,5mm	conforme conform conforme gleichmässig conforme	200 <7,5mm	conforme conform conforme gleichmässig conforme	-	-
		<b>Módulo de ruptura Modulus of rupture</b> Coefficient de rupture Bruchmodul Módulo de rotura	≥ 35 N/mm <sup>2</sup>	55 N/mm <sup>2</sup>	≥ 35 N/mm <sup>2</sup>	55 N/mm <sup>2</sup>	-	-	>15 N/mm <sup>2</sup>	27 N/mm <sup>2</sup>
ISO 10545-7		Resistência a abrasão Resistance to abrasion Beständigkeit gegen Oberflächenverschleiss Resistencia à la abrasión	1 - 5	2	-	-	2	1 - 5	-	III-1500 rev.
ISO 10545-8		Dilatação Térmica linear *MK(-1) Coeff. of linear thermal expansion *MK(-1) Coeff. d'expansion thermique linéaire *MK(-1) Linearer Wärmeausdehnungs-koeffizient *MK(-1) Coeff. de dilatación térmica lineal *MK(-1)	≤ 9,0	7,0	≤ 9,0	7,0	-	7,5	<7,0	-
ISO 10545-9		Resistência ao choque térmico Thermal shock resistance Resistance aux chocs thermiques Temperaturwechsel beständigkeit Resistencia ao choque térmico	resiste	resiste resist résiste widerstandsfähig resiste	resiste	resiste resist résiste widerstandsfähig resiste	resiste	resiste resist résiste widerstandsfähig resiste	resiste	resiste resist résiste widerstandsfähig resiste
ISO 10545-12		Resistência ao gelo Frost resistance Résistance au gel Frostbeständigkeit Resistencia al hielo	requisito request demand anfrage solicitud	resiste resist résiste widerstandsfähig resiste	requisito request demand anfrage solicitud	resiste resist résiste widerstandsfähig resiste	-	-	-	-
ISO 10545-11		Resistência a gretagem Crazeing resistance Résistance aux tréssaillures Haarrisse	-	-	-	-	requisito request demand anfrage solicitud	resiste resist résiste widerstandsfähig resiste	requisito request demand anfrage solicitud	resiste resist résiste widerstandsfähig resiste
ISO 10545-14		Resistência a manchas Stain resistance Résistance aux taches Flecken beständigkeit Resistencia a las manchas	-	-	-	-	3 Min.	4 - 5	3 Min.	5
ISO 10545-15		Resistência a produtos químicos domésticos Resistance to domestic chemical products Résistance aux produits chimiques Beständigkeit gegen Chemikalien Resistencia a los productos quimicos	Min. GB	conforme conform conforme gleichmässig conforme	Min. UB	conforme conform conforme gleichmässig conforme	Min. GB	conforme conform conforme gleichmässig conforme	Min. GB	GA
ISO 10545-13		Resistência a ácidos e bases de baixa concent. Resistance to acids and low concentration bases Résistance aux acides et aux bases à faible concentration Widerstandsfähig gegenüber niedrig konzentrierten Säuren und Laugen Resistencia a los ácidos y a bases de baja concentración	-	GLA	-	ULA	-	≥ GLB	-	GHA



**CARATTERISTICHE TECNICHE DI RESISTENZA ALLO SCIVOLAMENTO**  
**ANTI-SLIP TECHNICAL FEATURES - CARACTÉRISTIQUES TECHNIQUES DE RÉSISTANCE AU GLISSEMENT**  
**TECHNISCHE EIGENSCHAFTEN DER RUTSCHFESTIGKEIT - CARACTERÍSTICAS TÉCNICAS DE RESISTENCIA AL DESLIZAMIENTO**  
**Технические характеристики сопротивления скольжению**

**NORMATIVA TEDESCA DIN 51130 - GERMAN STANDARD - NORMES ALLEMANDES - DEUTSCHE NORMEN - NORMAS ALEMANAS - НЕМЕЦКИЙ СТАНДАРТ**

**CATEGORIE DI RESISTENZA ALLO SCIVOLAMENTO CON PIEDI CALZATI**

**SLIP RESISTANCE GROUPS WITH FOOTWEAR - CATEGORIES DE RÉSISTANCE AU GLISSEMENT LES PIEDS CHAUSSÉS**  
**RUTSCHHEMMUNGSKATEGORIEN MIT SCHUHWERK - CATEGORÍAS DE RESISTENCIA AL DESLIZAMIENTO CON PIES CALZADOS**  
**КАТЕГОРИИ СОПРОТИВЛЕНИЯ СКОЛЬЖЕНИЮ ПРИ ХОЖДЕНИИ В ОБУВИ**

ASTM C - 1028 - >0,6	NORMA AMERICANA ASTM C 1028 - COEFFICIENTE DI ATTRITO STATICO AMERICAN NORM ASTM C 1028 - COEFFICIENT OF STATIC FRICTION NORME AMERICAINE ASTM C 1028 - COEFFICIENT DE FRICTION STATIQUE AMERIKANISCHE NORM ASTM C 1028 - HAFTREIBUNGSKOEFFIZIENT АМЕРИКАНСКИЙ СТАНДАРТ ASTM C 1028 - КОЭФФИЦИЕНТ СТАТИЧЕСКОГО ТРЕНИЯ
B.C.R. - >0,40	<b>DETERMINAZIONE DELLA RESISTENZA ALLO SCIVOLAMENTO</b> SLIPPING RESISTANCE COEFFICIENT - DETERMINATION DE LA RÉSISTANCE AU GLISSEMENT ERMITTLUNG DER RUTSCHFESTIGKEIT - ОПРЕДЕЛЕНИЕ СОПРОТИВЛЕНИЯ СКОЛЬЖЕНИЮ
DIN 51130	<b>CATEGORIE DI RESISTENZA ALLO SCIVOLAMENTO CON PIEDI CALZATI</b> SLIP RESISTANCE GROUPS WITH FOOTWEAR - CATEGORIES DE RÉSISTANCE AU GLISSEMENT LES PIEDS CHAUSSÉS RUTSCHHEMMUNGSKATEGORIEN MIT SCHUHWERK - КАТЕГОРИИ СОПРОТИВЛЕНИЯ СКОЛЬЖЕНИЮ ПРИ ХОЖДЕНИИ В ОБУВИ
<b>Coefficiente di Attrito</b> Coefficient of friction - Coefficient de Friction Reibungskoeffizient - Coefficiente de agate Коэффициент трения	<b>Angoli di Inclinazione</b> Angle - Angle d'Inclinaison Neigungswinkel - Angulos de inclinación Углы наклона
<b>R9</b>	<b>Campi di Applicazione</b> Field of application - Domaines d'Utilisation Anwendungsbereich - Campos de aplicación Сфера применения
<b>R10</b>	<b>Ambienti residenziali, scuole, studi medici, ecc.</b> Residential environments, schools, surgeries, etc. Milieux résidentiels, écoles, cabinets de médecins, etc. Wohnbereich, Schulen, Arztpraxen usw. Ambientes residenciales, escuelas, estudios médicos, etc. Жилые помещения, школы, медицинские амбулатории и т.д.
<b>R11</b>	<b>Toilettes, magazzini, garages cucine di locali pubblici, ecc.</b> Bathrooms, warehouses, garages, kitchens of restaurants, etc. Toilettes, magasins, garages, cuisines d'établissements publics, etc. Toiletten, Lagerhallen, Garagen, Großküchen usw. Baños, almacenes, garajes, cocinas de locales públicos, etc. Туалеты, склады, кухни общественных заведений и т.д.
<b>R12</b>	<b>Lavorazione formaggi, celle frigorifere, lavanderia, ecc.</b> Dairies, cold rooms, laundries, etc. Travail du fromage, chambres frigorifiques, blanchisseries, etc. Käsen, Wäscherei, Kühlräume usw. Elaboración quesos, salas frigoríficas, lavanderías, etc. Сыроваренные цеха, холодильные камеры, прачечные и т.п.
	<b>Lavorazione carni, cucine industriali, zuccherifici, ecc.</b> Meat processing, industrial kitchens, sugar production, etc. Travail de la viande, cuisines industrielles, sucreries, etc. Fleischverarbeitung, Industrieküchen, Zuckerfabriken sw. Tratamiento de carnes, cocinas industriales, azucareras, etc. Мясоперерабатывающие цеха, промышленные кухни, сахарные заводы и т.д.

**CATEGORIE DI DESTINAZIONE D'USO PER SUPERFICI CALPESTABILI CON PRESENZA DI ACQUA A PIEDI NUDI**

**SLIP RESISTANCE GROUPS BAREFOOT ON WET SURFACE - CATEGORIES DE DESTINATION D'UTILISATION POUR SURFACES PIETINABLES EN PRESENCE D'EAU LES PIEDS NUS**  
**BEANSPRUCHUNGSKATEGORIEN FÜR BARFUß BEGEBBARE OBERFLÄCHEN BEI NÄSSE - CATEGORÍAS DE DESTINO DE USO PARA SUPERFICIES PISABLES CON PRESENZA DE AGUA CON PIES DESCALZOS**  
**КАТЕГОРИИ НАЗНАЧЕНИЯ ПОВЕРХНОСТЕЙ ПРИ НАЛИЧИИ ВОДЫ И ХОЖДЕНИИ БОСИКОМ**

Gruppi di valutazione	Angoli di Inclinazione	Campi di Applicazione
<b>A</b>	<b>&gt;=12°</b>	<b>Sgogliatoi, zone di passaggio a piedi nudi, ecc.</b> Dressing rooms, areas likely to be walked on barefoot, etc. Vestiaires, zones de passage les pieds nus, etc. Umkleieräume, Barfuß-Durchgangsbereiche usw. Vestuarios, zonas de paso con pies descalzos, etc. Раздевалки, зоны хождения босиком и т.д.
<b>B</b>	<b>&gt;=18°</b>	<b>Dacce, bordi piscine, ecc.</b> Shower enclosures, swimming pool decks, etc. Douches, bords des piscines, etc. - Duschen, Schwimmbadbränder usw. Duchas, bordes de piscina, etc. - Душ, борта бассейнов и т.д.
<b>C</b>	<b>&gt;=24°</b>	<b>Bordi di piscina in pendenza, scale immerse, ecc.</b> Sloping swimming pool decks, submerged stairs, etc. Bords des piscines en pente, escaliers plongés, etc. Schwimmbadbränder mit Gefälle, sich im Wasser befindliche Treppen usw. Bordes de piscina con pendenza, escaleras sumergidas, etc. Наклонные борта бассейнов, погруженные в воду лестницы и т.д.

**V4 = 4 cm³ / dm²: indicato per autolavaggi, produzione mangimi, cucine ospedali, ecc.**

**V4 = 4 cm³ / dm²: suitable for car washes, fodder production plant, hospital kitchen, etc.**

**V4 = 4 cm³ / dm²: indiqué pour les postes de lavage voitures, la production des provendes, les cuisines des hôpitaux.**

**V4 = 4 cm³ / dm²: geeignet für Autowaschanlagen, Futtermittelherstellung, Krankenhausküchen usw.**

**V4 = 4 cm³ / dm²: indicado para autolavados, producción de piensos, cocinas de hospitales, etc.**

**V4 = 4 cm³ / dm²: подходит для моек автомобилей, цехов производства кормов, больничных кухонь и т.д.**

**V = VOLUME MINIMO DI DEFUSSO DELL'ACQUA (DRENAGGIO)**

**V = MINIMUM WATER DRAINAGE LEVEL**

**V = VOLUME DE REFLUX DE L'EAU (DRAINAGE) MINIMUM**

**V = MINDEST-ENTWÄSSERUNGSRÄUM (DRAINAGE)**

**V = VOLUMEN MÍNIMO DE FLUJO DEL AGUA (DRENAJE)**

**V = МИНИМАЛЬНЫЙ ОБЪЕМ СТЕКАНИЯ ВОДЫ (ДРЕНАЖ)**

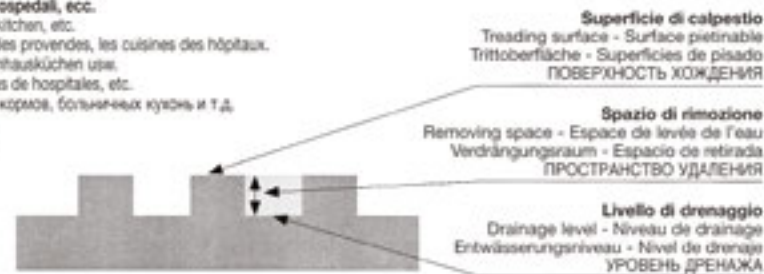

**CTE Código Técnico de la Edificación Spanish Building Code**

The CTE, **Código Técnico de la Edificación**, dentro de su Documento Básico de seguridad de Utilización 1 "DB SU 1 - seguridad frente al riesgo de caídas", define los requisitos que debe cumplir un suelo para poder ser utilizado como pavimento de los edificios o zonas de uso sanitario, docente, comercial, administrativo, aparcamiento y pública concurrencia (excluidas las zonas de uso restringido). Para ello, el pavimento deberá cumplir con un valor mínimo al deslizamiento "Rd".

El valor de resistencia al deslizamiento "Rd", se determina mediante el ensayo del péndulo descrito en el Anexo A de la norma UNE-ENV 12633: 2003.

"Safety of Use" Basic Document 1 ("DB SU 1 - Preventing Falls") of the Spanish Building Code (the CTE in Spanish) defines the requirements that a floor covering must meet in buildings or areas used for health-related, educational, commercial, administrative or public purposes or for parking (excluding areas of restricted use). To comply, the flooring must achieve a minimum slip resistance (Rd) value.

The slip resistance (Rd) value is determined using the pendulum test described in Appendix A of standard UNE-ENV 12633: 2003.

La siguiente tabla establece la clasificación de los suelos según su resbaladidad:

The following table shows the rating system for flooring, depending on its slip resistance.

Resistencia al deslizamiento Rd	Clase Rating	-rubiceramic
Rd ≤ 15	0	
15 < Rd ≤ 35	1	
35 < Rd ≤ 45	2	
Rd > 45	3	

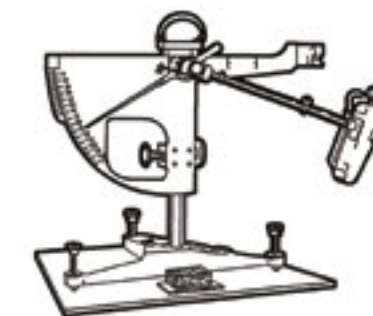

Clase exigible a los suelos en función de su localización:

Rating required for flooring depending on its location:

Localización y características de suelo	Clase Rating
<b>Zonas interiores secas:</b> Dry indoor areas:	
-Superficies con pendiente menor que el 6%	1
-Surfaces with a slope of less than 6%	
-Superficies con pendiente igual o mayor que el 6% y escaleras	2
-Surfaces with a slope equal to or higher than 6% and stairs	
<b>Zonas interiores húmedas, tales como las entradas a los edificios desde el espacio exterior<sup>(1)</sup>, terrazas cubiertas, vestuarios, duchas, baños, aseos, cocinas, etc.:</b> Indoor areas subject to moisture, such as entrances to buildings from outdoor areas <sup>(1)</sup> , covered terraces and balconies, changing rooms, showers, bathrooms, cloakrooms, kitchens etc:	
-Superficies con pendiente menor que el 6%	2
-Surfaces with a slope of less than 6%	
-Superficies con pendiente igual o mayor que el 6% y escaleras	3
-Surfaces with a slope equal to or higher than 6% and stairs	
<b>Zonas interiores donde, además de agua, pueda haber agentes (grasas, lubricantes, etc.) que reduzcan la resistencia al deslizamiento, tales como cocinas industriales, mataderos, aparcamientos, zonas de uso industrial, etc.</b> Indoor areas where, in addition to water, there might be agents (grease, lubricants etc.) that reduce the slip resistance of the floor, such as industrial kitchens, abattoirs, car parks, areas for industrial use etc.	3
<b>Zonas exteriores. Piscinas<sup>(2)</sup></b> Outdoor areas. Swimming pools <sup>(2)</sup>	3

<sup>(1)</sup> Excepto cuando se trate de accesos directos a zonas de uso restringido

Except for accesses that lead directly to areas of restricted use

<sup>(2)</sup> En zonas previstas para usuarios descalzos y en el fondo de los vasos, en las zonas en las que la profundidad no excede de 1.50 m.

In places where users are expected to go barefoot and in the bottom of swimming pools in areas with a depth of less than 1.50 m.

Dicha clase se mantendrá durante la vida útil del pavimento.

This rating is maintained throughout the useful life of the flooring.



## Aplicação, limpeza e manutenção

**Os produtos Rubicer apresentam-se em vários tipos de acabamentos e formatos, que devem ser tomados em consideração na escolha do produto para o tipo de utilização pretendida.**

Cuidados a ter antes de encomendar:

É importante que o cliente escolha o produto não só pelo factor estético mas, também, tendo em conta as características técnicas, que se devem adequar às exigências do local onde vai ser aplicado.

Durante a execução da obra haverá sempre quebras de material, conseqüentes de cortes, furos, acidentes, etc. Para além disso, por vezes, as medições dos espaços não são muito exactas e, por estas razões, para prevenir indesejadas faltas de material, recomenda-se que o cliente encomende cerca de 5 a 10% de produto a mais, em relação à área prevista.

Conferir o produto antes do Assentamento

Antes de começar a aplicar o material, o cliente deverá confirmar a quantidade e inspeccionar algumas caixas, de modo a verificar se o produto, o calibre e a tonalidade são aqueles que encomendou.

Deve fazer-se um painel com peças de varias caixas/paletes, para verificar se existe alguma mistura de tonalidades. Em alguns casos o pavimento/revestimento cerâmico tenta reproduzir produtos naturais e como ele próprio é produzido a partir de matérias-primas naturais, é normal que possam existir pequenas variações na tonalidade mas que não afectam e, por vezes, até enriquecem, esteticamente, o painel final. Em alguns padrões rústicos, as diferenças de tonalidade são propositadas, de forma a reproduzir o produto natural que o inspirou. Pelas razões descritas, é aconselhável, durante a colocação, misturar peças de várias caixas.

Durante o Assentamento

É muito importante que o suporte onde o material vai ser aplicado esteja perfeitamente nivelado, isento de qualquer sujidade e completamente estável. No caso em que a aplicação do material se vai efectuar sobre outro já existente, deve garantir-se que o anterior esteja bem aplicado, sem mosaicos mal colados. Deve ensaiar-se previamente a cola, de modo a garantir que esta adere bem à superfície do suporte (poderá ser necessário atacar a superfície, mecanicamente ou quimicamente, para aumentar a aderência da cola). O produto cerâmico tem como principal característica ser um material rígido, não deformável, pelo que, algumas variações dimensionais na estrutura devem ser acomodadas pelo suporte e/ou confinadas às juntas de dilatação.

As juntas de aplicação devem ter, no mínimo, 3mm (ou 2mm, no caso de material rectificado), de forma a minimizar as pequenas diferenças dimensionais (comuns, neste tipo de produto), disfarçar os defeitos de aplicação e poderem absorver pequenas deformações que podem ocorrer na estrutura, durante a execução da obra. Recomenda-se a utilização de cruzetas, cunhas ou fio para juntas, para facilitar e permitir um bom alinhamento dos peças.

O tipo de cola a utilizar depende muito da natureza da obra (se se trata de revestimento de chão ou de parede, do tipo de utilização do local, etc.), da aderência do suporte e do tipo e material cerâmico a aplicar (da sua porosidade). O grés porcelânico, devido à sua porosidade quase nula, é, dos produtos cerâmicos, aquele que necessita de uma escolha mais cuidadosa em relação ao tipo de cola e processo de colagem. Normalmente, para este tipo de material é recomendada a utilização de uma cola de ligantes mistos (cimento e resina), para conseguir uma máxima aderência entre as peças e o suporte, e evitar que se formem espaços ocos, recomenda-se a utilização da técnica de colagem dupla (aplicação de cola no tardoz do peça e no suporte). Durante a aplicação, de tempos a tempos, deve-se “descolar” (levantar) algumas peças para verificar a eficácia da colagem. A aplicação deve ser efectuada por profissionais experientes que, em todo o caso, devem seguir as recomendações do fabricante (mistura dos componentes, preparação e tempos de secagem).

Deve ter-se, também, cuidado com as condições ambientais, dado que a temperatura, a humidade e o vento podem influenciar o tempo e a qualidade da colagem.

A aplicação desencontrada” deve ser ensaiada, previamente, para verificação do resultado final. Pequenas diferenças de planaridade nas peças, que são admissíveis neste tipo de material (apesar de os valores de planaridade estarem perfeitamente de acordo com os parâmetros estabelecidos pela norma europeia EN 14411) são exponenciadas por este tipo de aplicação.

Não se aconselha a utilização de martelos de borracha negra para bater as peças pois estes podem deixar marcas/resíduos de borracha (utilizar martelos de borracha branca e/ou proteger o material com um pano, antes de bater).

Não se deve riscar o material não vidrado (porcelânico ou polido) com marcadores de tinta permanente nem raspar com objectos metálicos na sua superfície.

Deve ter-se especial cuidado na aplicação de juntas de cor (evitar as juntas negras que contêm carvão micronizado) sobre o material, especialmente nas cores claras e produtos polidos. O porcelânico, apesar de possuir uma porosidade quase nula, apresenta na sua superfície uma pequena rugosidade (material mate) ou micro porosidade (polido) que pode dificultar a limpeza dos resíduos de junta colorida, depois desta secar.

O material polido da Rubicer é protegido com um impermeabilizante anti-mancha, de modo a facilitar a sua limpeza durante e após a obra; no entanto, pode não ser suficiente, se não se proceder a uma limpeza cuidada e atempada do material.

Recomenda-se que, imediatamente após a junta secar, se limpe os excessos destes produtos com um pano humedecido (segundo sempre as indicações do fabricante).

Os nossos produtos podem, também, ser utilizados em sistemas de fixação mecânica, como pavimento (pavimentos sobrelevados) ou como revestimento (fachadas ventiladas).

Final de obra

A maioria dos problemas manifestados após a obra deve-se a uma má e, por vezes, inexistente limpeza após aplicação.

No final da obra, deve proceder-se à limpeza de toda a superfície, de forma a eliminar os resíduos de cimentos, colas, juntas e a sujidade da obra, em geral. Para isso, aconselha-se a utilização de um desincrustante comercial de base ácida (os tempos recomendados de secagem da cola e das juntas devem ser respeitados, já que o ácido poderá deteriorar estes materiais e manchar a superfície do pavimento se as colas ainda não estiverem “curadas”). No final, deve lavar-se toda a superfície com água abundante.

Se ainda houver trabalhos para realizar no local que possam causar riscos ou outros danos na superfície dos ladrilhos, deve proteger-se todo o material (normalmente, cobre-se com cartão ou plástico grosso).

Limpeza e Manutenção em utilização

O grés porcelânico não vidrado, polido ou macio, necessita de especial atenção em relação à limpeza de alguns tipos de manchas.

A limpeza quotidiana é simples, bastando utilizar um detergente comercial e água limpa; e, na limpeza de manchas específicas, consultar a tabela.

As manchas de cor (café, vinho, cola, graxa, etc.) sobre o porcelânico devem ser imediatamente limpas com um pano húmido; caso contrário, podem necessitar da utilização de um detergente específico para as remover.

Deve ter-se cuidado com a utilização de detergentes comerciais específicos para retirar determinados resíduos difíceis (aluminios, tintas, etc.) porque, devido à sua composição química, podem degradar a superfície de alguns produtos cerâmicos vidrados e polidos. Nunca se deve utilizar produtos que contenham ácido fluorídrico, pois atacam o material cerâmico.

Uma das marcas que possui uma vasta gama de produtos destinados à limpeza e tratamento de produtos cerâmicos, e que foram testados nos nossos laboratórios, é a Fila. No entanto existem no mercado outras empresas que comercializam produtos de limpeza específicos para este tipo de material.

Deve ter-se especial atenção na utilização de produtos oleosos (azeite, óleos, ceras, etc.) que podem formar, em alguns materiais, uma película que provoca um efeito similar ao do impermeabilizante podendo originar, em algumas cores, uma alteração do tom, quando sujeitos a contraluz. A remoção dessa película pode ser mais ou menos difícil consoante o tipo de material e do tempo da mancha.

Nota: Por precaução, os produtos de limpeza mais fortes devem ser, sempre, previamente testados numa zona pequena e pouco visível, de modo a verificar os seus possíveis efeitos.

## Installation, cleaning and maintenance

**Our products come in various types of finishes and formats that must be taken into account when choosing the product for the type of intended use.**

Cautions before ordering:

It is important that the customer choose the product by a factor not only the aesthetic but also taking into account the technical characteristics of the same, these should suit the requirements of the place where they will be installed.

During the execution of the works it will result always some material breakage, resulting from cuts, holes, accidents, etc. In addition, sometimes the measurements of the areas are not very accurate and for these reasons, to prevent unwanted material shortages, it is recommended that the client orders about 5 to 10% more product in relation to the area provided.

Check the product before the fixing:

Before starting to fix the material, the customer must confirm the amount and inspect some of boxes in order to verify that the product, size and shade are those that he ordered.

The client should do a panel with several pieces of different boxes / pallets, to check if there is a mix of shades. Sometimes the ceramic floor tile attempts to reproduce natural products and as itself is produced from natural raw materials, it is normal that there may be a slight variation of shade but not affecting it's aspect and sometimes even garnish, aesthetically, the final panel. In some rustic products, the differences in shade are deliberate in order to reproduce the material in which the product was inspired. For the reasons described, it is advisable during installation to use pieces from several boxes.

During the fixing:

It is very important that the support in which the material will be applied is perfectly levelled, free of any dirt and completely stable. In the event that the installation of the tiles is to take place over an existing one, the fixer must ensure that the former floor tiles are well installed, without any mosaics poorly glued. The adhesive should be tested before the fixing, in order to ensure that it adheres well to the surface of the support (you may need to attack the surface either mechanically or chemically, to increase the adhesion of the adhesive). The ceramic tiles whose main feature is a rigid material, non-deformable, so that some dimensional variations in the structure must be accommodated by the support and / or absorbed by the joints.

The joints must have at least 3mm (or 2mm in the case of a rectified product) to minimize small dimensional differences (common in this type of product); to disguise the defects of the installation and be able to absorb small deformations that may occur in the support during the execution of the works. It is recommended the use of crosses, wedges or wire together to facilitate and ensure the proper alignment of tiles.

The type of the adhesive glue depends on the nature of the work (if it is to floor covering or wall, the type of site, etc.), adherence of the support and the type of the ceramic tiles to be installed (depending on its porosity). The porcelain tiles, due to its almost zero porosity, are the ceramic tiles that need a more careful choice about the type of adhesive and bonding process.

Typically, this type of material is recommended to use a mixed adhesive glue (cement and resin), to obtain maximum adhesion between the tiles and the support, and prevent the formation of hollow areas, it is recommended to use the technique double glue (glue on the backside of the tile and also in the support). During the application, from time to time, one should remove a few tiles to verify the effectiveness of the adhesive glue. The application must be made by, experienced professionals who should follow the recommendations of the manufacturer (mixture of components, preparation and drying periods).

The fixing of the tiles should also be careful with the weather conditions such as temperature, humidity and wind can influence the drying period and quality of the adhesion.

The “staggered” installation of tiles should be tested in advance to verify the final result. Small differences in the flatness of the tiles, which are admissible in this type of material (although the flatness values are accordingly with the values established by the European standard EN 14411), these value are taken to it’s maximum with this type of application.

It is not recommended the use rubber mallets to tap the pieces as they may leave marks / residues of rubber (use silicone mallets or protect the material with a cloth before tapping). One should not scratch the unglazed material (porcelain or polished) with permanent ink markers or scrape with metal objects on its surface.

The installer should be especially careful with the use of coloured grouts (avoid black grouts containing micronized coal) on the material, especially with light colours and polished products. The tiles, despite having almost zero porosity, on the surface they have a small roughness on the surface (matt finish) or micro-porosity (polished finish) that can hinder the cleaning of the remains of the coloured grouts after drying.

The polished material of Rubicer is treated with an anti-stain sealer in order to facilitate cleaning during and after the installation, however, it may not be sufficient, if it is not done a careful and timely cleaning of the material.

It is recommended that, immediately after the grout dry, the tile fixer should wipe the excess with a wet cloth (always following the manufacturer’s instructions).

Our products can also be used with other fixing systems, such as floor (raised floors) or as a coating (ventilated facades).

Final work:

Most of the problems reported after the tile works are done, are due to a poor and sometimes non-existent cleaning after tiles are laid.

At the end of the works, it should take place a cleaning operation of the entire surface in order to eliminate the waste of cements, adhesives and dirt from the works in general. For this, we recommend the use of a commercial acid based detergent (the recommended time for drying of the adhesive cement glue and the grouts must be respected, once the acid may deteriorate and stain the floor area where the glue is not yet ready). In the end, you should wash the entire surface with plenty of water.

If there is still work to do on site that may cause scratches or other damage on the surface of the tiles, these should be protected (usually with cardboard or thick plastic).

Cleaning and Maintenance:

The unglazed porcelain tiles polished or honed, need special attention in relation to the cleaning of some type of stains.

The daily cleaning is simple, once it requires only a commercial detergent and clean water.

The stains such as, coffee, wine, coke, grease, etc. on the porcelain tiles should be immediately cleaned with a wet cloth, otherwise it may require the use of a specific detergent to remove them.

You should be careful with the use of commercial detergents to remove certain specific difficult stains (aluminium, paints, etc), because due to its chemical composition, they can degrade the surface of some glazed tiles and polished porcelain tiles. You should never use products containing hydrofluoric acid, because they damage all ceramic tiles.

One of the brands with a wide range of products for cleaning and maintenance of ceramics, which was tested in our laboratories, is Fila. However, other companies sell cleaning products specific to this type of material.

You should give especial attention to the use of oily products (olive oils, waxes, etc) that may form in some materials, a coating that causes an effect similar to a sealer, which can result in some colours to a change in shade when subject to counter light. The removal of this coat can be more or less difficult depending on the type of material and the time of the stain.

Note: As a precaution, stronger cleaning products should be previously tested in a small and less visible area, in order to verify their possible effects.

## Application, nettoyage et entretien

**Toutes ces variantes doivent être prises en compte lors du choix du matériel et ce en fonction de l’utilisation prévue.**

Recommandations avant de commander:

Il est important que le client choisisse le produit, non seulement, pour son coté esthétique mais aussi selon ses caractéristiques techniques, qui doivent être adéquates aux exigences du lieu où il va être appliqué.

Lors de l’exécution du chantier, il y a bien entendu des pertes de matériel dû aux coupes, perforations ou bien encore à des petits incidents, à cela s’ajoute également bien des fois une prise des mesures des locaux erronées.

Pour toutes ces raisons et pour éviter un manque de matériel, nous conseillons au client de commander 5 à 10 % de matériel en plus de la quantité normalement nécessaire.

Vérification du produit avant application:

Avant toute application, le client doit confirmer la quantité ainsi que vérifier quelques boites afin de contrôler que le produit, le calibre et la nuance reçus soient bien ceux commandés.

Il est recommandable de réaliser un panneau utilisant divers carreaux, de diverses boites et de diverses palettes afin de vérifier qu’il n’y a aucun mélange en terme de tonalité.

Attendu que le carreau de sol et mur céramique essaye de reproduire un effet naturel et est lui-même produit grâce a des matières-premières naturelles, il est probable et normal qu’il existe quelques petites variations de tonalité, ce qui n’affecte en rien, mais au contraire bien des fois enrichit esthétiquement le panneau définitif.

Sur certains carreaux rustiques, les différences de tonalités sont voulues afin de reproduire le produit naturel duquel il s’inspire.

Pour tout cela, nous recommandons que la pose soit faite en mélangeant les pièces provenant de boites différentes.

Durant la pose:

Il est important que le support sur lequel le matériel va être appliqué soit parfaitement et correctement nivelé, sans aucune trace de saleté et complètement stable.

Au cas où la pose est faite sur d’autres carreaux déjà existant, il faut vérifier que ceux-ci soient bien appliqués et qu’aucun ne soit décollé.

La colle doit être testée afin de confirmer que celle-ci adhère convenablement à la surface de pose (il se peut qu’il soit nécessaire de traiter cette surface, mécaniquement ou à l’aide de produit chimique, afin d’augmenter le taux d’adhérence de la colle).

Le produit céramique a comme caractéristique principale d’être un matériel rigide et indéformable d’où le fait que certaines variations dimensionnelles dans la structure devront être accommodées par le support et/ou ajustées aux joints de dilatations

Les joints doivent être au minimum de 3 mm (ou 2 mm dans le cas d’un matériel rectifié) de manière à réduire les légères différences dimensionnelles (communes dans ce genre de produits), dissimuler les défauts d’applications et pouvoir absorber les petites déformations qui peuvent être présente dans la structure lors du déroulement du chantier.

Nous recommandons l’utilisation de petites croix/croisette ou fil pour joint afin de faciliter et permettre un correct alignement des pièces.

Le choix de la colle à utiliser dépend beaucoup de la nature du chantier (s’il s’agit de revêtement de sol ou mural, du type d’utilisation du local, etc.), de l’adhérence du support et du type de matériel céramique à appliquer (de sa porosité). Le grés céramico, du fait de sa porosité presque nul, est, des produits céramiques, celui qui nécessite d’un choix plus attentif par rapport au type de colle et processus de collage. Normalement, pour ce type de matériel il est recommandé l’utilisation d’une colle de fixation mixte (ciment et résine), pour obtenir le maximum d’adhérence entre les pièces et le support, et éviter la formation d’espaces vides, nous recommandons l’

utilisation de la technique de collage double (application de la colle dans le verso de la pièce ainsi que sur le support). Au moment de l’application, de temps en temps, il faut “décoller” (lever) quelques pièces pour vérifier l’efficacité du collage. L’application doit être effectuée par des professionnels expérimentés qui, dans tous les cas, doivent suivre les recommandations du fabricant( mélange des composés, préparation et temps de séchage). Il faut faire, aussi, attention aux conditions climatiques, à savoir que la température, l’humidité et le vent peuvent influencer le temps et la qualité du collage.

“L’application désaligné” doit être initialement testé, pour vérification du résultat final. Des petites différences de planéité des pièces, qui sont admissibles dans ce type de matériel (sachant que les résultats de planéité sont parfaitement en accord avec les paramètres stipulés par la norme européenne EN 14411) sont exponentielles par ce type d’application.

L’utilisation du marteau en caoutchouc noir n’est pas conseillé car ceux-ci peuvent laisser des marques/résidus de caoutchouc (utiliser des marteaux à caoutchouc blanc et / ou protéger le matériel avec un torchon, avant de taper).

Il ne faut pas rayer un carreau non émaillé (cérame ou poli) avec des marqueurs d’ence permanente ni froter avec des objets métalliques sur la surface.

Il faut être très attentif dans l’application de joints de couleurs (éviter les joints noirs qui contiennent du charbon micronisé) sur le matériel, spécialement sur les couleurs claires et produits polis. Le cérame, malgré le fait de posséder une porosité quasiment nul, présente en surface une petite rugosité (matériel mat) ou micro porosité (poli) qui peut dificulté le nettoyage des résidus de joints de couleurs, après le séchage de ceux-ci.

Le matériel poli de chez Rubicer est protégé avec un imperméabilisant anti tâche, de façon à faciliter son nettoyage durant et après le chantier, cependant, il est possible, que cela ne soit pas suffisant, si le nettoyage du matériel n’est pas fait de façon soigné et en temps nécessaire Il est conseillé que, immédiatement après le séchage du joint, que le surplus des produits soient retirés à l’aide d’un torchon humide (en suivant toujours les indications du fabricant). Nos produits peuvent, aussi, être utilisés sur des systèmes de fixation mécanique, comme les pavements (pavements surélevés) ou comme les revêtements (façades ventilés).

Fin de chantier

La majeure parti des problèmes survenus après le chantier est dû à une mauvaise et parfois inexistence de nettoyage après l’application du produit.

A la fin du chantier il faut procéder au nettoyage de toute la surface de façon à éliminer les résidus de ciment, colles, joints et saleté du chantier, en général. Pour cela il est conseillé l’utilisation d’un desincrustant commercial à base acide (le temps recommandé de séchage de la colle et des joints doit être respecté, vu que l’acide peut détériorer ces matériaux et tâcher la surface de sol si les colles ne sont pas encore «sèche »). à la fin, il faut laver toute la surface avec de l’eau abondante.

Dans le cas où il existe encore des travaux à réaliser dans le local qui puisse causer des rayures ou autres dommages sur la surface des carreaux il faut protéger tout le matériel (normalement il doit être couvert avec du carton ou du plastique épais).

Nettoyage et Manutention en utilisation

Le grés cérame non émaillé, poli ou adouci, a besoin d’une attention spécial relativement au nettoyage de certains types de tâches.

Le nettoyage quotidien est facile, il est simplement nécessaire d’utiliser un détergent commercial et de l’eau.

Les taches de couleur (café, vin, colle, cirage, etc.) sur le grés cérame doivent étres immédiatement nettoyés avec un torchon humide ; dans le cas contraire, il peut être nécessaire l’utilisation d’un détergent spécifique pour les enlever.

Il faut faire attention à l’utilisation d’un détergent commercial spécifique pour enlever certains résidus difficiles (aluminium, teinte, etc.) parce que dû à leur composition chimique, ils peuvent dégrader la surface de certains produits émaillés et polis.

Ne jamais utiliser des produits qui contiennent de l’acide fluorhydrique, sachant qu’ils agressent le matériel céramique.

L’une des marques qui a une vaste gamme de produits destinées au nettoyage et traitement des produits céramiques et qui a été testé dans nos laboratoires est la marque Fila. Cependant il existe sur le marché d’autres entreprises qui commercialisent les produits de nettoyage spécifiques pour ce type de matériel.

Il faut avoir une attention spéciale dans l’utilisation de produits grasseux (huile d’olive, huile, cire, etc.) qui peuvent former, sur certains matériaux, une pellicule qui provoque un effet similaire à celui de l’impermeabilisant pouvant donner origine dans certaines couleurs, à une modification de tonalité, quand exposés en contre jour. Le nettoyage de cette pellicule peut être plus ou moins difficile selon le type de produit et du temps de la tache.

Nota: Pour précaution, les produits de nettoyage plus agressives doivent étres toujours préalablement testés dans une petite zone et pas trop visible, de façon à vérifier les possibles effets.

## Aplicación, limpieza y mantenimiento

**Los productos Rubicer vienen en diferentes formas y acabados, que deben tenerse en cuenta en la elección del tipo de producto para el uso previsto.**

El cuidado antes de ordenar:

Es importante que el cliente elija el producto no sólo para el factor estético, sino también teniendo en cuenta las características técnicas, que deben adaptarse a los requisitos del sitio donde se va a aplicar.

Durante la ejecución de los trabajos siempre será rompe material, causada por cortes, pinchazos, accidentes, etc. Además, a veces las mediciones de los espacios no son muy precisos, y por estas razones, para evitar la escasez de materiales no deseados, se recomienda que la orden del cliente 5 y el 10% del producto en relación con el área esperada.

Compruebe el producto antes de la aplicación

Antes de la aplicación, verifique si el material corresponde: al modelo, a la selección (calidad), al lote (tonalidad) y al calibre deseado. Verifique todas las cajas para tener la seguridad de que todo es correcto. Conserve los datos del material impresos en el embalaje. Rubicer no acepta las reclamaciones una vez que el material sea aplicado, en caso de que el defecto sea visible antes de la aplicación del material.

Se debe hacer nn panel con varios piezas de cajas / paletas para ver si hay alguna mezcla de tonos. En algunos casos, el suelo / baldosas de cerámica y productos naturales tratan de jugar como el mismo es producido a partir de materias primas naturales, es normal que puede haber pequeñas variaciones en el tono, pero que no afecta, ya veces incluso el enriquecimiento, estéticamente, la panel de extremo. En algunos modelos rústicos, las diferencias de tono son a propósito con el fin de reproducir el producto natural de inspiración. Por las razones descritas, es recomendable durante la colocación, mezclar piezas de varias cajas.

Durante la aplicación

Es muy importante que la soporte en lo que se aplicará el material es perfectamente nivelado, libre de cualquier suciedad y completamente estable. En el caso de que la aplicación del material se llevará a cabo en uno existente, debe garantizarse que el primero se aplica bien, demosaicó mal pegado. Se debe probarse de antemano el pegamento a fin de garantizar que se adhiera bien a la superficie del soporte (puede ser necesario para atacar la superficie mecánicamente o químicamente, para aumentar la adherencia de la cola). Siendo característica principal del producto cerámico un material no deformable, rígido por lo que algunas variaciones dimensionales en la estructura deben ser acomodados por el apoyo y / o confinados a las articulaciones.

Las articulaciones de aplicación deben ser de al menos 3 mm (o 2 mm en el caso del material rectificado) para reducir al mínimo las diferencias pequeñas dimensiones (comunes en este tipo de producto), defectos de disfraz en la aplicación y ser capaz de absorber pequeñas deformaciones puede ocurrir en la estructura durante la ejecución del trabajo. Se recomienda el uso de perchas, cuñas o unión de alambre para facilitar y asegurar la correcta alineación de las piezas.

El tipo de adhesivo a utilizar depende en gran medida de la naturaleza de la obra (si es el suelo o la pared, el tipo de uso de los locales, etc), la adherencia del soporte y del tipo y material cerámico que se aplica (su porosidad). Los azulejos de porcelana, debido a su casi nula porosidad es de productos cerámicos, que requiere una selección más cuidadosa sobre el tipo de proceso de adhesivo y unión.

Normalmente, para este tipo de material, se recomienda utilizar un aglutinante mixto adhesiva (resina y cemento); para obtener la máxima adherencia entre las partes y el apoyo y prevenir la formación de huecos, se recomienda el uso de la técnica de doble encolado (aplicación de pegamento en la cara interior de la pieza y el soporte). Durante la aplicación, de vez en cuando, deben “despegue” (levantar) algunas partes para verificar la eficacia de unión. La aplicación debe ser realizada por profesionales con experiencia que, en cualquier caso, deben seguir las recomendaciones del fabricante (mezcla de componentes, preparación y tiempo de secado). También se debe tener cuidado de las condiciones ambientales, ya que la temperatura, la humedad y el viento pueden influir en el tiempo y la unión.

La “aplicación escalonada” se someterá a ensayo con antelación para comprobar el resultado final. Pequeñas diferencias en la planeidad de las partes, que son admissibles en este tipo de material (aunque los valores de planitud son perfectamente de acuerdo con los parámetros establecidos por la norma europea EN 14411) se exponentes por este tipo de aplicación.

No es aconsejable el uso de martillos para golpear las piezas de caucho negro, ya que pueden dejar marcas / caucho de desecho (utilizar martillos de goma blanca y / o proteger el material con un paño antes de golpear).

Não se deve riscar o material não vidrado (porcelânico ou polido) com marcadores de tinta permanente nem raspar com objectos metálicos na sua superfície.

Se debe tener especial cuidado en la aplicación de colores juntos (evitar las juntas negras que contienen carbón micronizado) del material, especialmente en colores claros y producto pulido. La porcelana, a pesar de tener casi ninguna porosidad, presenta en su superficie una pequeña rugosidad (materia mate) o micro porosidad (polido) que puede dificultar la limpieza de los residuos de color se une después de este seco.

El material de pulido Rubicer está protegido con un blindaje anti-manchas con el fin de facilitar la limpieza durante y después del trabajo; Sin embargo, puede no ser suficiente si no se compromete una limpieza cuidadosa y oportuna de los equipos.

Se recomienda que inmediatamente después de la junta seca, limpiar los excesos de estos productos con un paño húmedo (siempre siguiendo las instrucciones del fabricante).

Nuestro producto también puede ser utilizado en sistemas de sujeción mecánicos, tales como el suelo (suelos elevados) o recubrimiento (fachadas ventiladas).

Fin de trabajo

La mayoría de los problemas se manifiestan después del trabajo debido a una limpieza deficiente y en ocasiones inexistente después de la aplicación.

Al final de la obra, proceder a la limpieza de toda la superficie para eliminar los cementos de desecho, adhesivos, juntas y la suciedad de trabajo en general. Por esto, se recomienda el uso de una base de ácido desincrustante comercial (el tiempo de secado recomendado de la cola y las juntas deben ser respetados, ya que el ácido se puede deteriorar estos materiales y manchar la superficie del pavimento si los adhesivos aún no están “curada”). En el extremo, debe lavar toda la superficie con agua.

Si todavía queda trabajo por realizar en el lugar que pueden causar arañazos u otros daños en las baldosas, que debe protegerse a si mismo todo el material (generalmente cubre con cartón o plástico grueso).

Limpeza y Mantenimiento en uso

O grés porcelânico não vidrado, polido ou macio, necessita de especial atenção em relação à limpeza de alguns tipos de manchas.

A limpeza quotidiana é simples, bastando utilizar um detergente comercial e água limpa; e, na limpeza de manchas específicas, consultar a tabela.

As manchas de cor (café, vinho, cola, graxa, etc.) sobre o porcelânico devem ser imediatamente limpas com um pano húmido; caso contrário, podem necessitar da utilização de um detergente específico para as remover.

Deve ter-se cuidado com a utilização de detergentes comerciais específicos para retirar determinados resíduos difíceis (aluminios, tintas, etc.) porque, devido à sua composição química, podem degradar a superfície de alguns produtos cerâmicos vidrados e polidos. Nunca se deve utilizar produtos que contenham ácido fluorídrico, pois atacam o material cerâmico.

Uma das marcas que possui uma vasta gama de produtos destinados à limpeza e tratamento de produtos cerâmicos, e que foram testados nos nossos laboratórios, é a Fila. No entanto existem no mercado outras empresas que comercializam produtos de limpeza específicos para este tipo de material.

Deve ter-se especial atenção na utilização de produtos oleosos (azeite, óleos, ceras, etc.) que podem formar, em alguns materiais, uma película que provoca um efeito similar ao do impermeabilizante podendo originar, em algumas cores, uma alteração do tom, quando sujeitos a contraluz. A remoção dessa película pode ser mais ou menos difícil consoante o tipo de material e do tempo da mancha.

Nota: Como medida de precaução, los productos de limpieza más fuertes deben ser probados consistentemente en un área pequeña y poco visible, a fin de comprobar sus posibles efectos.